



# Full Manual

## IP Camera

### IN-Series



Learn more about **eneo IN series**  
on our YouTube channel.

# TABLE OF CONTENT

<b>ABOUT THIS DOCUMENT .....</b>	<b>5</b>
<b>SAFETY INSTRUCTIONS .....</b>	<b>6</b>
<b>OPEN SOURCE SOFTWARE LICENSE INFORMATION.....</b>	<b>8</b>
<b>1 - OVERVIEW .....</b>	<b>10</b>
1.1 - Scope of Application.....	10
1.2 - Product Description.....	10
1.3 - Operating Environment .....	11
<b>2 - DEVICE CONNECTION.....</b>	<b>12</b>
2.1 - Connecting a PC .....	12
2.2 - Connecting through a Router/Switch .....	12
2.3 - Connection to Alarm Device .....	13
2.4 - Connection to Audio Device .....	14
2.5 - Connection to an external adapter.....	14
<b>3 - IPC IP ADDRESS SETTING VIA DEVICE CONFIG TOOL.....</b>	<b>15</b>
<b>4 - LOGIN FROM WEB CLIENT.....</b>	<b>16</b>
4.1 - Accessing the camera from the Web Client.....	16
4.2 - Initial Login.....	17
4.3 - Normal Login.....	18
4.4 - Password Retrieval .....	18
4.4.1 - Security Question Configuration .....	18
4.4.2 - Certificate of Authorization.....	19
4.5 - Password Expired .....	19
<b>5 - INSTALLING PLUG-IN.....</b>	<b>20</b>
<b>6 - LIVE VIEW.....</b>	<b>21</b>
6.1 - Live View Menu .....	21
6.2 - Recording Status .....	22
<b>7 - PLAYBACK .....</b>	<b>23</b>
7.1 - Normal Playback.....	23
7.2 - Image Search.....	25
7.3 - Playback by Tag .....	26
7.4 - Smart .....	27
7.5 - AI.....	29
7.5.1 - Face Search & Playback.....	29
7.5.2 - Human & Vehicle Search & Playback.....	30
7.5.3 - PID & LCD.....	31
7.5.4 - Repeat Customer Detection .....	32
7.5.5 - Face Attendance.....	34
7.5.6 - License Plate Detection .....	37
7.6 - Exported Video File .....	38
<b>8 - REMOTE SETTING.....</b>	<b>39</b>
8.1 - Live View .....	39
8.2 - Image Control .....	40
8.3 - Video Cover.....	43
8.4 - ROI.....	44
8.5 - Recording Parameters .....	45
8.5.1 - Encoding Parameters .....	45
8.5.2 - Recording Parameters.....	46
8.5.3 - Capture.....	48

<b>8.6 - Event Setup .....</b>	<b>50</b>
8.6.1 - Parameter Setup .....	50
8.6.2 - Alarm Setting .....	56
8.6.3 - Event Push Function Settings.....	61
<b>8.7 - AI.....</b>	<b>63</b>
8.7.1 - Setup .....	63
8.7.2 - Recognition.....	81
8.7.3 - Alarm Setup .....	86
8.7.4 - Statistics .....	92
<b>8.8 - Thermal .....</b>	<b>96</b>
8.8.1 - Fire detection .....	96
8.8.2 - Temperature measurement .....	97
8.8.2.1 - Temperature measurement parameter setting.....	97
8.8.3 - Thermal alarm schedule .....	101
8.8.4 - Thermal alarm schedule .....	102
<b>8.9 - Network Settings.....</b>	<b>103</b>
8.9.1 - Basic Settings .....	103
8.9.2 - SNMP .....	108
8.9.3 - FTP Server Settings .....	109
8.9.4 - RTSP Settings.....	110
8.9.5 - Dynamic Domain Name Settings.....	111
8.9.6 - HTTPS Settings .....	112
8.9.7 - IP Filter .....	113
<b>8.10 - Device Management .....</b>	<b>114</b>
8.10.1 - Disk Management .....	114
8.10.2 - Audio Management .....	116
8.10.3 - Cloud Storage Settings .....	117
<b>8.11 - System Settings .....</b>	<b>118</b>
8.11.1 - General.....	118
8.11.2 - Multi-user Management .....	120
8.11.3 - System Maintenance.....	122
8.11.4 - System Information .....	130
<b>9 - LOCAL SETTINGS .....</b>	<b>131</b>
<b>10 - APPENDIX .....</b>	<b>133</b>



## ABOUT THIS DOCUMENT

In this document you will find a comprehensive description of a specific series of devices, which we have prepared with great care and accuracy in order to provide you with a deep insight into the general functions and features that characterize this series of devices.

EN

However, you should be aware that the detailed characterization presented in this document is based on the general product line. The individual feature set of specific models or designs within this series may vary depending on their configuration.

The variations may be reflected in an expanded or limited scope of functions and features, thus the actual specifications of individual products may differ in some respects from the designs set forth in this document.

For this reason, we strongly recommend that you thoroughly consult the specific data sheet for the product in question. The data sheet contains specific, detailed information tailored to the particular model. It is the primary reference document that provides the most authentic and accurate information on the individual functionality and features of each specific product in our device series.

We thank you for your understanding and willingness to invest time in acquiring accurate knowledge about the specific product you have selected from our device series. Please do not hesitate to contact us should you have any further questions or require additional information.

## SAFETY INSTRUCTIONS

Read the safety instructions and the operating instructions carefully before installing the product.

Depending on the product type, individual points may be omitted.

### Mounting & Installation

- Ensure that the intended mounting location is suitable for the respective product (e.g. in terms of weight).
- Securely fasten the products to the locations and surfaces recommended by the manufacturer to ensure stability and safety.
- Ensure that the products are weatherproof when installed outdoors, e.g. protect cameras from direct sunlight or extreme temperatures.
- Make sure that any ventilation slots are not blocked to ensure sufficient air circulation and cooling.
- Make sure that cameras, switches, etc. are installed with sufficient safety distance to flammable materials, power sources, running water, etc.
- Assembly, commissioning and maintenance may only be carried out by authorized specialist personnel in compliance with the relevant standards and guidelines.

### Power supply & wiring

- To ensure a safe power supply, use only power supplies and cables recommended by the manufacturer.
- Make sure that the cables are properly routed and protected from tampering and damage (e.g. kinking) to avoid power failures or short circuits (e.g. due to moisture ingress).
- Make sure that the cables are not routed through doors, windows or other moving parts to avoid damage and tripping hazards.
- To disconnect the system from the power supply, pull the cable only by the plug and never directly by the cable.
- When shortening flexible connection cables, use wire end ferrules.

### Security

- Use strong passwords for all cameras and devices to prevent unauthorized access.
- Keep device firmware up to date to minimize security vulnerabilities.
- Protect (remote) access to the devices using secure methods such as encrypted connections or VPN.

## Operation

- The devices may only be operated within the temperature and humidity ranges specified in the data sheet.
- Sufficient ventilation must be provided to prevent overheating. This applies in particular to devices such as recorders and switches that can generate heat.
- Ensure that no sight lines are blocked and that accessories do not obscure areas used by other equipment or people.
- Ensure cameras are oriented to provide a clear view of the desired area without interfering with people's privacy.

EN

## Cleaning & Maintenance

- Clean the lenses and housings of the cameras regularly to ensure a clear view.
- Keep the ventilation slots clean and free of dust to ensure efficient cooling.
- Use a mild detergent for cleaning. Harsh cleaning agents such as thinner or benzine may permanently damage the surface.
- Check the product regularly for damage and signs of wear.
- Only use original spare parts (e.g. connection cable) or accessories from VIDEOR E. Hartig GmbH.
- Any tampering by unauthorized persons will void the warranty.
- Before opening the housing, disconnect the power supply.

## Warning, Privacy & Legal Notices

- Draw the attention of visitors to the fact that they are being recorded by means of clearly visible notices.
- If necessary, point out rules of conduct.
- Ensure that cameras are oriented in such a way that privacy is not violated, e.g., by recording neighbours or public areas.
- Comply with local laws and regulations on video surveillance and data protection (GDPR).

## OPEN SOURCE SOFTWARE LICENSE INFORMATION

The software components provided with eneo products may contain copyrighted software that is licensed under various open source software licenses. For detailed information about the contained open source software packages, the used package versions, license information and complete license terms, please refer to...

- the open source information included in your products user interface,
- the product detail pages on the eneo website ([www.eneo-security.com](http://www.eneo-security.com)),
- the eneo download portal (<https://datacloud.videor.com/s/eneodownloadportal>). In case that previous link is broken, the latest link to the eneo download portal can be found on the respective eneo product page at [www.eneo-security.com](http://www.eneo-security.com).
- the download package of your firmware. The complete open source software license information of your product is included in the corresponding software download package that can be found in our download portal.

If you are missing any information, please contact [opensource@eneo-security.com](mailto:opensource@eneo-security.com), we will of course be happy to provide you with the missing information and will also make the missing information available to the public.

If you want to get access to the open source components (source codes) used in our products, please contact [opensource@eneo-security.com](mailto:opensource@eneo-security.com).





## 1 - OVERVIEW

### 1.1 - Scope of Application

IP cameras with powerful image processing capabilities can be applied in various public places such as shopping malls, supermarkets, schools, factories and workshops, as well as environments requiring high definition video images such as banks and traffic control systems, as shown below:



### 1.2 - Product Description

An IP camera is a digital network monitoring camera that can operate independently with a built in web server, and can be used for real time monitoring from all over the world by using a web browser or client software.

The IP camera, based on the state of the art digital solution, is an integrated media processing platform for audio/video acquisition, compression and network transmission on a single board. It complies with H.264/H.265 High Profile coding standard. By typing the IP camera's IP address or domain name into a web browser, any remote user can perform real time monitoring. The IP camera solution is suitable for residential or commercial environments, as well as a variety of places requiring remote network video surveillance and transmission. The product is easy to install and user friendly.

The IP camera allows you to set multiple users with different permissions for easy management.

The IP camera has the motion detection function, and will actively send E mail, captured images or alarm video when an event occurs and store the alarm video in the TF card for easy retrieval.

### 1.3 - Operating Environment

**System:** Windows XP/Windows 7/ Windows 8/ Windows 10/ Windows 11/MacOS 10 or later.

**CPU:** Intel i3 or later

**Memory:** 2 GB or higher

**Video memory:** 1 GB or higher

**Display:** 1024×768 or higher

**Browsers:** IE10 & later, Chrome 57 & later, Firefox 52 & later, Edge 41 & later, and Safari 12 & later

## 2 - DEVICE CONNECTION

### 2.1 - Connecting a PC

Connect an IP camera directly to a PC via a network cable, connect the power input to the DC 12V adapter, and set the IP addresses of the PC and the IP camera on the same network segment. If the network is working properly, the IP camera will communicate with the PC within one minute of being turned on.

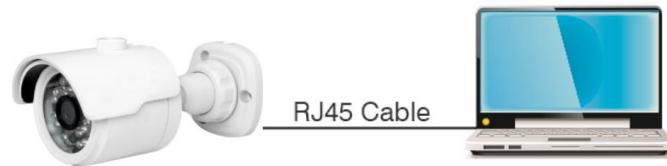

### 2.2 - Connecting through a Router/Switch

This connection method is used when connecting an IP camera to the Internet, where the IP camera and PC are connected to the LAN ports of a router/switch and the gateway of the camera is set to the IP address of the router.

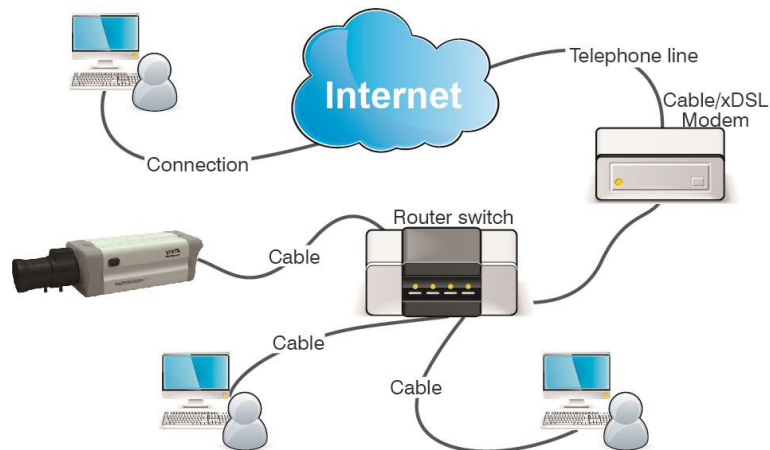

## 2.3 - Connection to Alarm Device

When connected to an alarm output device, the unit will send alarm information to the connected alarm device when an alarm is triggered. See below for details of connection methods:

EN

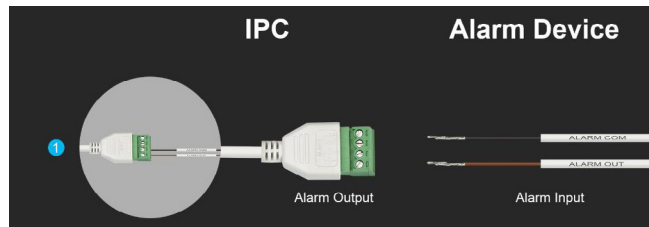

Connect the alarm terminal to the camera's alarm output, then connect the external alarm device to the alarm output. The camera interface wiring diagram is shown below for reference.

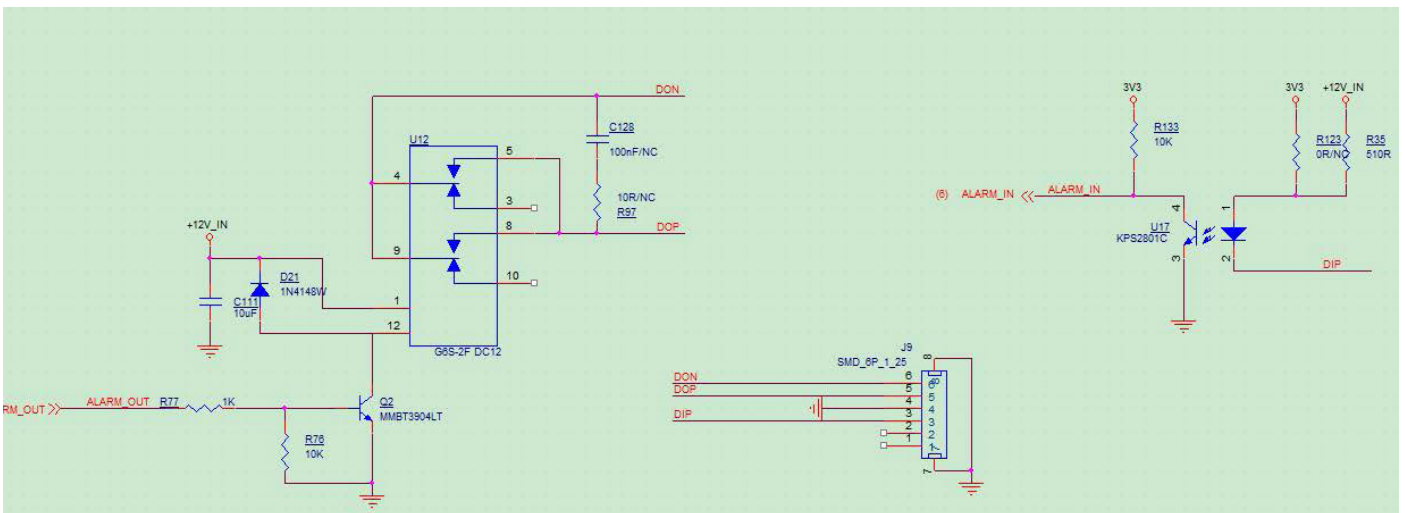

## 2.4 - Connection to Audio Device

The device can be connected to an external microphone and speaker via the connector below to realise the two-way audio function.

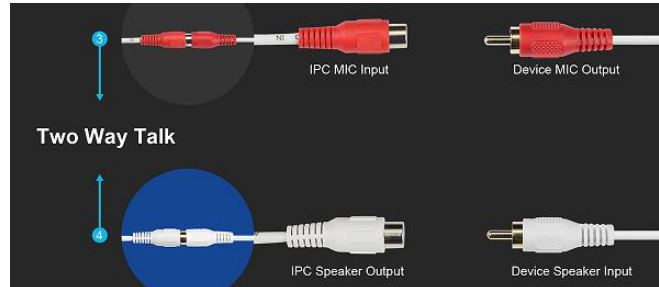

## 2.5 - Connection to an external adapter

The device plug can be connected to the power socket

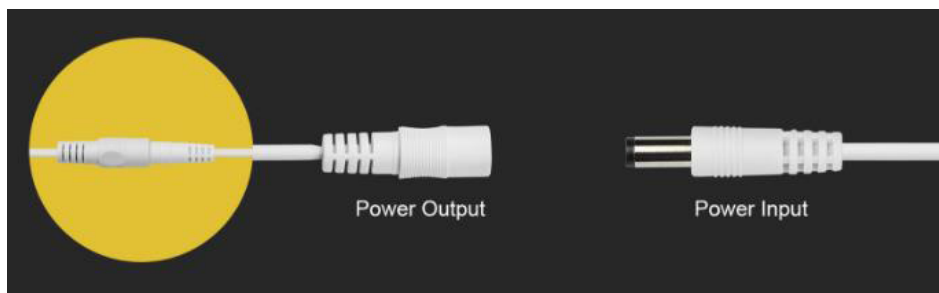

### 3 - IPC IP ADDRESS SETTING VIA DEVICE CONFIG TOOL

**Step 1** Run Device Config Tool, click Search to get the information of the IPCs in this LAN as shown in the figure below, and locate your desired IPC based the P2P or MAC address of the camera.

EN

No.	IP	Media Port	Web Port	Channel	Device Name	Device Type	Device Version	Net Mask	Gateway	MAC	Network Mode	P2P ID	Status
1	172.20.58.24	9000	80	1	327DE@307	RS-CH291M4MD-DF-WA2812PW	V18.25.8.2.2_220402	255.255.255.0	172.20.58.1	00-23-63-94-A7-01	DHCP	NKRKRSKQZV7TASSPT111A	
2	172.20.58.25	9000	80	1	RS-CH298M7A-LDF-LFWA2912PW	IP CAMERA	V31.35.8.2.2_220301	255.255.255.0	172.20.58.1	00-23-63-94-46-BC	DHCP	RSV2106001549442	
3	172.20.58.32	9000	80	1	H88	IP CAMERA	V1.0.0.00001701010103_220331	255.255.255.0	172.20.58.1	00-23-63-90-C4-CE	DHCP	H3LXD8D24U2PV0F4111A	
4	172.20.58.38	9000	80	1	IP CAMERA	IP CAMERA	V27.45.8.2.2_220318	255.255.255.0	172.20.58.1	00-23-63-91-EC-FB	DHCP	V5LR322778HP1HA111A	
5	172.20.58.37	9000	80	1	IP CAMERA	IP CAMERA	V31.35.8.2.2_220301	255.255.255.0	172.20.58.1	00-23-63-95-14-5C	DHCP	WRRNEW2B9XUNVR111A	
6	172.20.58.38	9000	80	1	IP CAMERA	IP CAMERA	V28.34.8.2.2_220402	255.255.255.0	172.20.58.1	00-23-63-90-8D-9C	DHCP	SRDGHGWYUFASCTX111A	
7	172.20.58.41	9000	80	1	99529_IM415	RS-CH349NM4C4-LDF-LFWA2912PW	V30.85.8.2.2_220412	255.255.255.0	172.20.58.1	00-23-63-94-A7-0D	DHCP	ZPBFUMZ75WHLPCW511...	
8	172.20.58.54	9000	80	40	DVR7115	DT115	V8.2.2-2020416	255.255.255.0	172.20.58.1	00-23-63-96-48-4F	DHCP	RSV211004372562	
9	172.20.58.58	9000	80	1	dml	RS-CH349MKRB-LTF-LFW38PW-M	V30.85.8.2.2_220412	255.255.255.0	172.20.58.1	00-23-63-94-A8-E1	DHCP	RSV2106001591170	
10	172.20.58.70	9000	80	1	IP CAMERA	IP CAMERA	V1.0.0.00001701010103_220331	255.255.255.0	172.20.58.1	00-23-63-98-C4-C4	DHCP	F27XFB2342FLHD5111A	

**NOTE:** The default IP address of the camera is 192.168.1.168, the default username is admin, the default password is admin.

**Step2** Select the corresponding device, enter your username and password, edit the corresponding network information, and click **Modify** to save changes.

**NOTE:** Change the Net Mode to DHCP to get the IP address if the current network supports DHCP.

The screenshot shows the 'Device Search' interface. At the top, there are tabs for 'Search', 'Upgrade', 'Config', 'Stream Config', 'OSD Config', 'Recovery', 'Import/Export', and 'Change Password'. Below the tabs is a table of devices. The table has columns for No., IP, Media Port, Web Port, Channel, Device Name, Device Type, Device Version, Net Mask, Gateway, MAC, Network Mode, P2P ID, and Status. The device with IP 172.20.58.23 is selected. Below the table, there is a 'User Info' section with fields for Username (admin), Password (\*\*\*\*\*), Start IP (172.20.58.100), Media Port (9000), Web Port (80), Gateway (172.20.58.1), Net Mask (255.255.255.0), and Network Mode (Static). A 'Modify' button is highlighted in red at the bottom right.

## 4 - LOGIN FROM WEB CLIENT

### 4.1 - Accessing the camera from the Web Client

Use the Device Config Tool to browse the IPCs on the current network. As shown in the following figure, click directly on an IP address and use your IE browser to log in to the corresponding camera.

No.	IP	Media Port	Web Port	Channel	Device Name	Device Type	Device Version	Net Mask	Gateway	MAC	Network Mode	P2P ID	Status
1	172.20.58.24	9000	80	1	327DE@307	RS-CH281MND-DF-WA2812PW	V18.25.8.2.2_220402	255.255.255.0	172.20.58.1	00-23-63-94-A7-01	DHCP	HKBRKSMXQV24SSSP111A	
2	172.20.58.25	9000	80	1	RS-CH281MNTA-LDF-LFWA2812PW	RS-CH281MNTA-LDF-LFWA2812PW	V31.35.8.2.2_220301	255.255.255.0	172.20.58.1	00-23-63-94-A6-BC	DHCP	RSV2106001549442	
3	172.20.58.32	9000	80	1	Hhh	IP CAMERA	V1.0.0.B0001701010103_220331	255.255.255.0	172.20.58.1	00-23-63-98-C4-CE	DHCP	H3LXSDQ24LQPVBF4111A	
4	172.20.58.36	9000	80	1	IP CAMERA	IP CAMERA	V27.45.8.2.2_220318	255.255.255.0	172.20.58.1	00-23-63-91-EC-FB	DHCP	V5LR322776HP1H4111A	
5	172.20.58.37	9000	80	1	IP CAMERA	IP CAMERA	V31.35.8.2.2_220301	255.255.255.0	172.20.58.1	00-23-63-92-14-5C	DHCP	WBRNEWB2B9JNV6R111A	
6	172.20.58.38	9000	80	1	IP CAMERA	IP CAMERA	V26.34.8.2.2_220402	255.255.255.0	172.20.58.1	00-23-63-98-8D-9C	DHCP	SRDGHQWYVFA57CX111A	
7	172.20.58.41	9000	80	1	98529_0M415	RS-CH340NAND-LDF-LFWA2812PW	V30.85.8.2.2_220412	255.255.255.0	172.20.58.1	00-23-63-94-A7-0D	DHCP	ZPBFUMZ75WHLPCW511	
8	172.20.58.54	9000	80	40	DVR7116	D7116	V8.2.2-20220416	255.255.255.0	172.20.58.1	00-23-63-98-48-4F	DHCP	RSV2111004372562	
9	172.20.58.58	9000	80	1	dml	RS-CH340NAKRB-LTF-LFW38PW-M	V30.85.8.2.2_220412	255.255.255.0	172.20.58.1	00-23-63-94-A6-E1	DHCP	RSV2106001591170	
10	172.20.58.70	9000	80	1	IP CAMERA	IP CAMERA	V1.0.0.B0001701010103_220331	255.255.255.0	172.20.58.1	00-23-63-98-C4-C4	DHCP	F2TXPBB234ZFLH05111A	

User Info: Username: admin Password: \*\*\*\*\* Device Info: IP: 172.20.58.41 Media Port: 9000 Web Port: 80 Gateway: 172.20.58.1 Net Mask: 255.255.255.0 Net Mode: DHCP

Alternatively, you can open your IE browser and enter the following information in the address bar HTTP://ip:web port. As shown in the figure above, the IP address of the device to be accessed is 172.20.58.41, the web port number is 80 and the combined URL is http://172.20.58.41:80.

**NOTE:** In practical applications, the default HTTP access mode is port 80.



## 4.2 - Initial Login

First, access the camera from a web client. As the device's default password is simple, the programme will display the screen shown below, asking you to set a more complex password. Click to review the password setting requirements: A password must be between 8 and 15 characters long, consisting of letters, numbers or special characters.

1. A string of 8 to 9 characters containing at least three uppercase letters, lowercase letters, digits, or special characters.
2. A string of 10 to 15 characters containing at least two uppercase letters, lowercase letters, digits, or special characters.
3. Do not contain more than four consecutive or repeated characters.
4. Do not contain more than four consecutive key patterns.



Set a new password and click OK to save your change. The web client will display the screen as shown below. Users can open the corresponding password retrieval method by checking the box, or cancel the setting directly without checking the box, and do not enable the password retrieval function.

1. **Security Question Configuration:**  
To change the user password by question verification, check the Security Question Configuration, select three questions out of 15, and set the answers to a maximum length of 64 characters to retrieve your password.
2. **Certificate of Authorisation:**  
To change the user password using a certificate, select the Authorisation certificate and click Export to download the certificate.txt file.

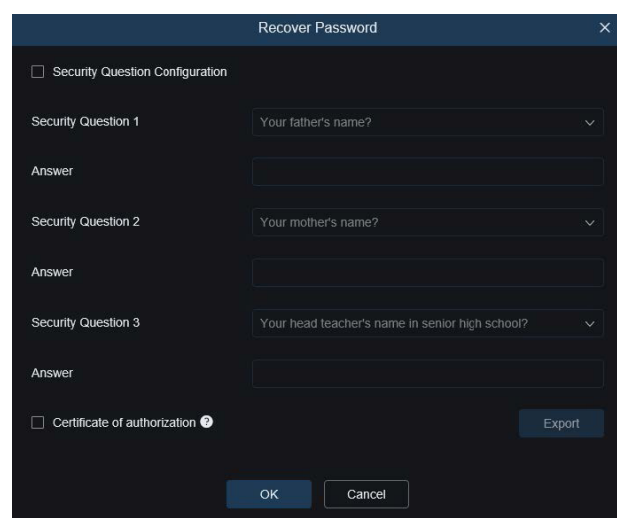

**NOTE:** Keep your verification information properly when the password retrieval function is enabled.

## 4.3 - Normal Login

After accessing from the Web Client, you will be taken to the login screen as shown below. Enter your username and password and click Login to access the operating screen. You can also select your preferred language when logging in.

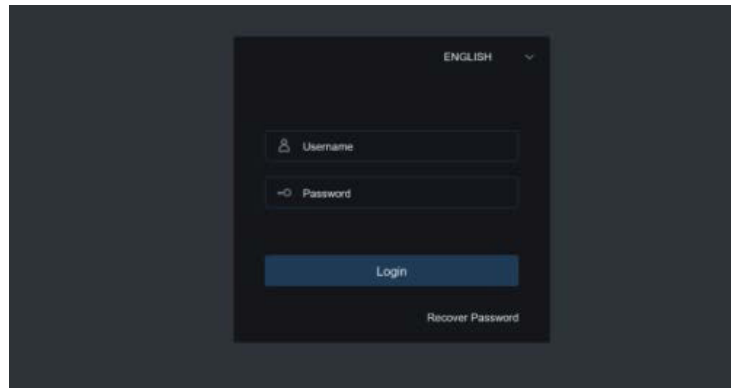

## 4.4 - Password Retrieval

If the password retrieval feature is enabled and you have forgotten your login information, you can click Recover Password to display the Recover Password screen. You can choose between the configuration of the security question and the certificate of authorisation when you first log in to retrieve your password.

### 4.4.1 - Security Question Configuration

You can change the user password by setting security questions in the Recover Password screen, as shown below. Enter the answers to the security questions. You can change the user password directly.

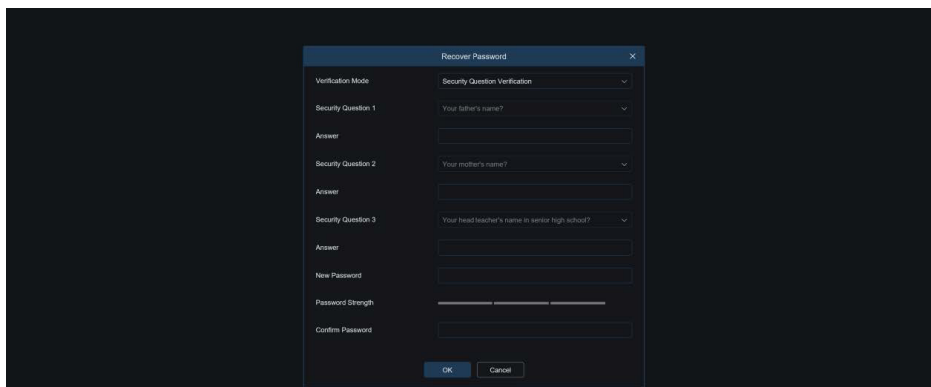

## 4.4.2 - Certificate of Authorization

If you set security questions at first login, you will be prompted to download the certificate.txt file if you choose to recover the user password using the Certificate of Authentication. On the Recover Password screen, click Recover Password and import the certificate.txt file to reset the password, as shown below. Click Import and select the certificate.txt file. Then enter a new password to change the user password.

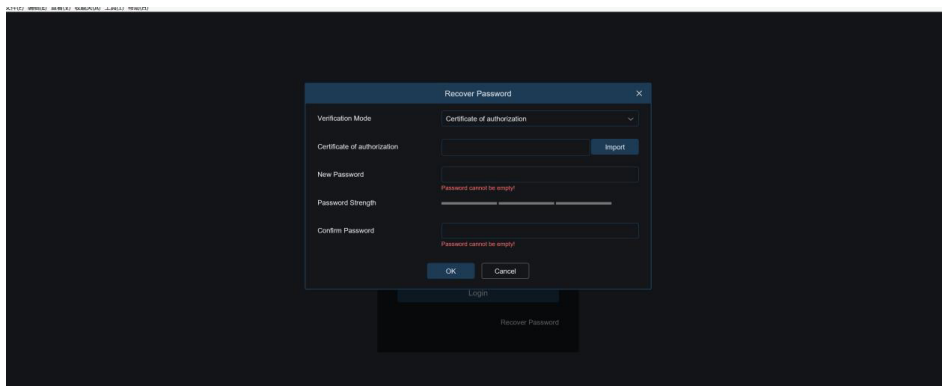

## 4.5 - Password Expired

We recommend that you change your password regularly, especially in the high security system. To better protect your products, the system will record the system time you changed the password. After 90 days, system will ask for password change.

1. Go to **Password**
2. Enter the **old** password and click **Next**
3. Enter a **new** password and confirm again Click **OK**.

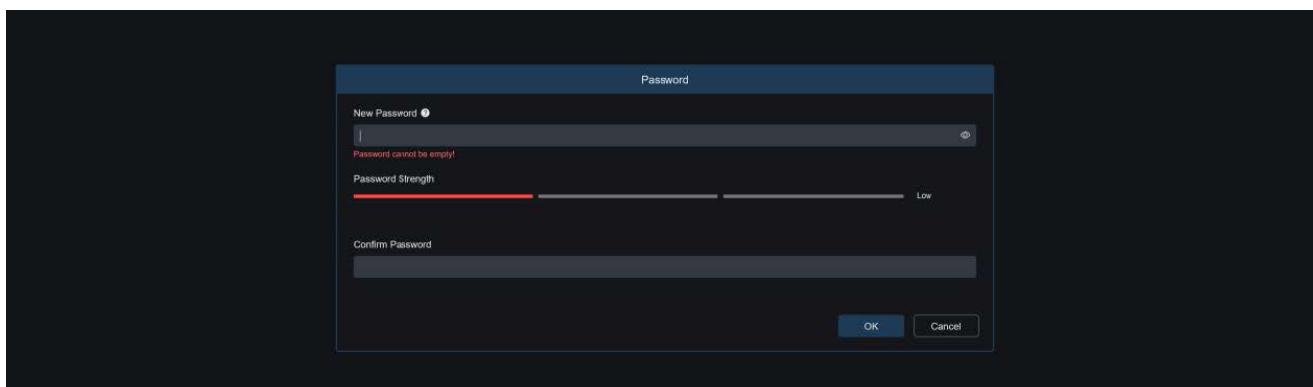

## 5 - INSTALLING PLUG-IN

You will only be able to preview an image if you have the plug-in installed when you log in from within your IE browser. Download and install the plugin by following the instructions on the screen as shown below.

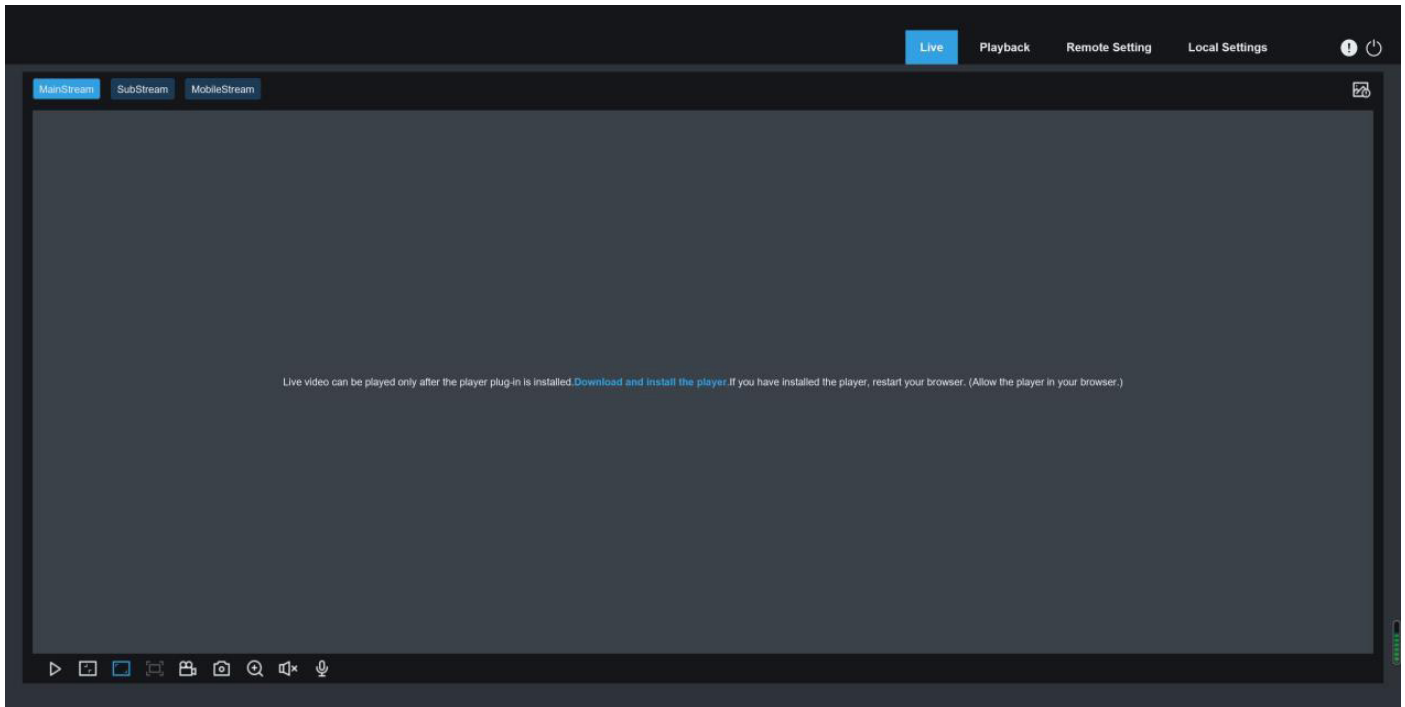

**i** **NOTE:** You can skip the plugin installation when you access the web client from Safari 12 & later, Chrome 57 & later, Firefox 52 & later, and Edge 41.

## 6 - LIVE VIEW

### 6.1 - Live View Menu

EN

After logging in, the Web Client displays the Login Live view, as shown below.

 **NOTE:** Features may differ depending on product models.

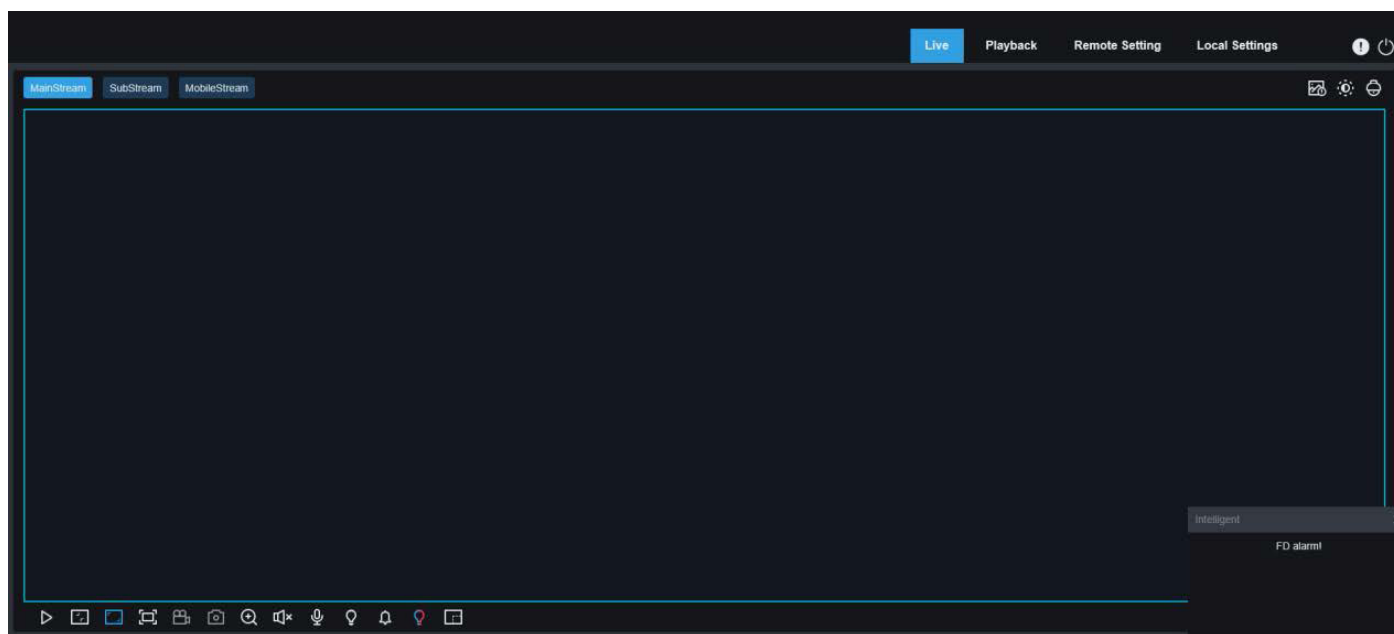

**Stream switching menu:** Stream switching menu: In the top left corner, you can switch the image quality of the current live view:

**Main stream:** HD picture, but higher bandwidth and PC performance requirements.

**Substream:** Moderate bandwidth and PC performance requirements, but lower picture quality compared to the main stream.

**Mobile stream:** Lowest bandwidth and PC performance requirements, and lowest picture quality.

**Main switching bar:** Switches between web functionality screens. The web client has four menus: Live, Playback, Remote Setting, Local Settings.

**Info:** Displays information about the active user, web version and plug-in version.

**AI Alarm:** Used to open the alarm push bar on the right and push images during face alarm and human & vehicle detection.

**Colour:** Adjusts the current image settings, such as saturation and sharpness.

**PTZ setting:** Used for PTZ settings and re-focusing.

**Exit:** Log out.

**Recording & Alarm Status:** Displays the alarm and recording status of the camera. See section 6.2 for details.

**Stop/Play:** Allows you to stop and replay the preview of the current stream.

**Original Proportions:** Displays the current live view in its original proportions.

**Stretch:** Displays the current live view in a way that stretches the display area.

**Full Screen:** Displays the live view in full screen. You can double-click the screen to enable or disable this feature, and press Esc to exit full screen mode.

**Record:** Allows you to manually record the stream in preview.

**Capture:** Allows you to manually capture the image of the current stream.

**Digital Zoom:** Allows you to zoom in on a specific area of the screen.

**Audio:** Used to turn on/off or adjust the audio in the preview.

**Voice Command:** Allows you to communicate with the camera.

**Warning light:** Used to manually turn the white light on/off.

**Siren:** Used to manually turn the siren on/off.

**Pixel counter:** Used to select an area to check its pixel size in the stream.

**Pop-up Info:** Displays the current alarm arm in the bottom right corner.

## 6.2 - Recording Status

The recording status is a simple representation of the current alarm on the Web Client and indicates whether the recording is normal. A number of alarms can be stored at the same time as described below:

**No Icon:** The Memory Card is operating normally but not recording.

**R (red):** The camera is recording normally.

**H (red):** The memory card is normal. Check the memory card.

**M (green):** Motion alarm is detected but motion alarm recording is not enabled.

**M (red):** Motion alarm is detected and motion alarm recording is enabled.

**I (green):** An I/O alarm is in progress, but the I/O alarm recording is not enabled.

**I (red):** An I/O alarm is in progress, and the I/O alarm recording is enabled.

**PIR (green):** A PIR alarm is in progress, but the PIR alarm recording is not enabled.

**PIR (red):** A PIR alarm is in progress, and the PIR alarm recording is enabled.

**S (green):** An intelligent alarm is in progress, but the intelligent alarm recording is not enabled.

**S (red):** An intelligent alarm is in progress, and the intelligent alarm recording is enabled.

 **NOTE:** When the camera is recording an alarm, the icon disappears, but the normal recording process continues.

 **NOTE:** Intelligent alarms include face, human, and vehicle alarms.

## 7 - PLAYBACK

Not only does the camera need to be able to show us images in real time, it also needs to be able to store the image information so that we can retrieve it when we need it.

EN

### 7.1 - Normal Playback

The playback function mainly includes general video search and AI search, as shown below.

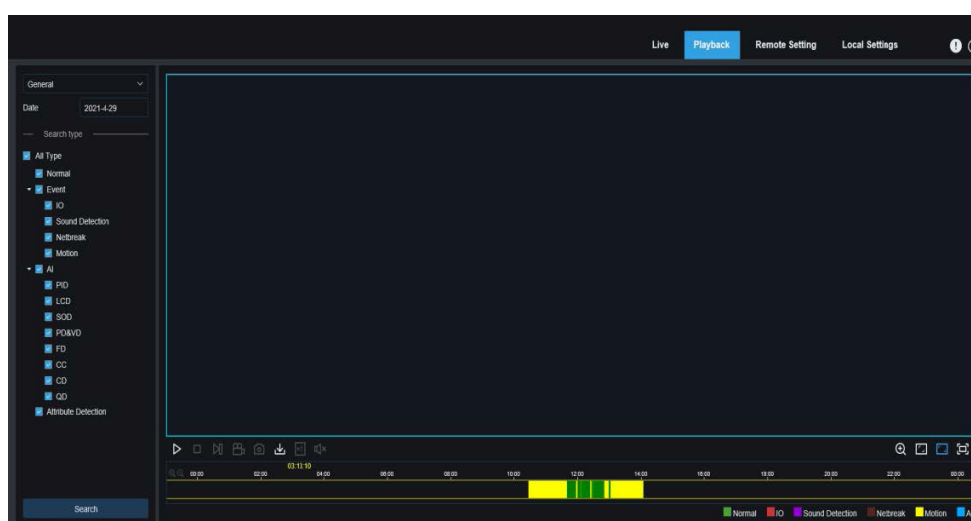







**Search Mode Switch:** Used to switch the search functions as shown in the figure above. By default, General is selected to search for general recorded files. See the next part of this section to switch to AI image search.

**Date:** Used to set the date to search for recorded files. Click Search. You will be prompted with the dates of available recorded files.

**Search type:** Displays the search types supported by the camera. You can search for a part of the recorded files, if necessary.

**Search:** Displays and searches for recorded files stored on the memory card according to the search settings.

-  **Pause/Play:** Used to pause/play streams.
-  **Stop:** Used to stop streams.
-  **Forward by one frame:** Advances one frame at a time.
-  **Record:** Allows you to manually record the stream in preview.
-  **Capture:** Allows you to manually capture the image of the current stream.
-  **Download:** Download the searched recording file.

 **Speed:** Supports 1/8, 1/4, 1/2, 1, X2, X4 and X8 speed playback.

 **Audio:** Used to turn on/off or adjust the sound of the stream.

**Playback progress bar:** The time bar at the bottom shows the current playback progress. Bar and playback progress in different colours based on the search results.

 **Digital Zoom:** Allows you to zoom in on a specific area of the stream.

 **Original Proportions:** Displays the current live view in its original proportions.

 **Stretch:** Displays the current live view by stretching the display area.

 **Full Screen:** Displays the playback stream in full screen. You can double-click the screen to enable or disable this feature, and press Esc to exit full screen mode.

**Playback progress bar:** By default, the progress bar shows the progress within 24 hours. You can zoom in and out of the progress bar to get a better view of the playback position. You can also use the mouse wheel to zoom in and out of the progress bar.



## 7.2 - Image Search

With Auto Capture enabled, you can browse and play back images on this screen.

EN

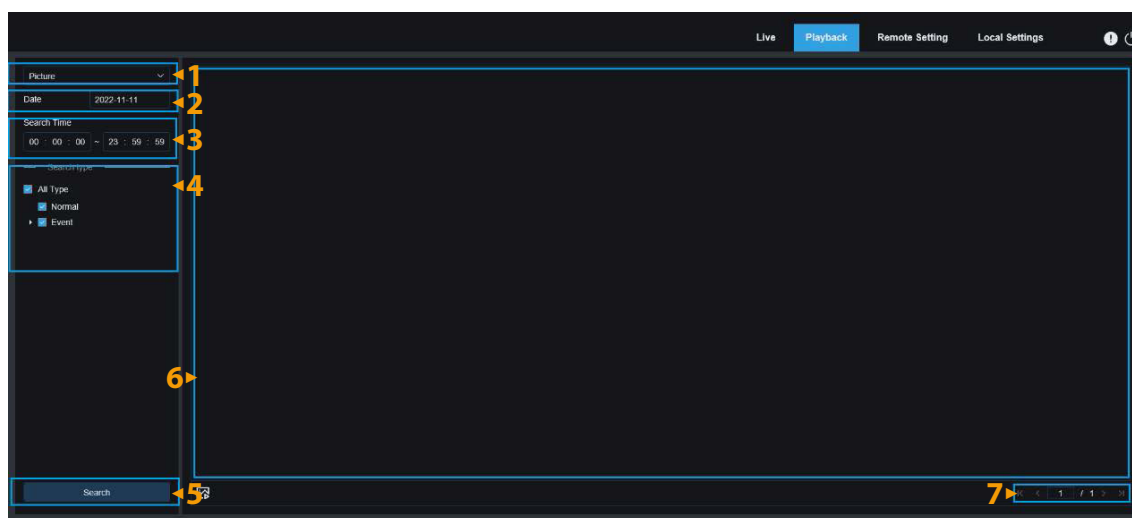



1. **Search Mode Switch:** Used to switch the current search function. The current search mode is Picture.
2. **Date:** Used to set the date to search for images. When you click Search, you will be prompted with the dates for which recorded files are available.
3. **Search Time:** Used to set the time to search for images, allowing users to search for images in a specific time period.
4. **Search Type:** Allows you to select the type of recording you want to search for, or check 'All types' to select all.
5. **Search:** Click Search to start searching for images.
6. **Search results display area:** Displays the desired search results. Double-clicking an image will play the video before and after the image.
7. **Scrolling through the search results:** You can scroll through the search results in the bottom right corner.

## 7.3 - Playback by Tag

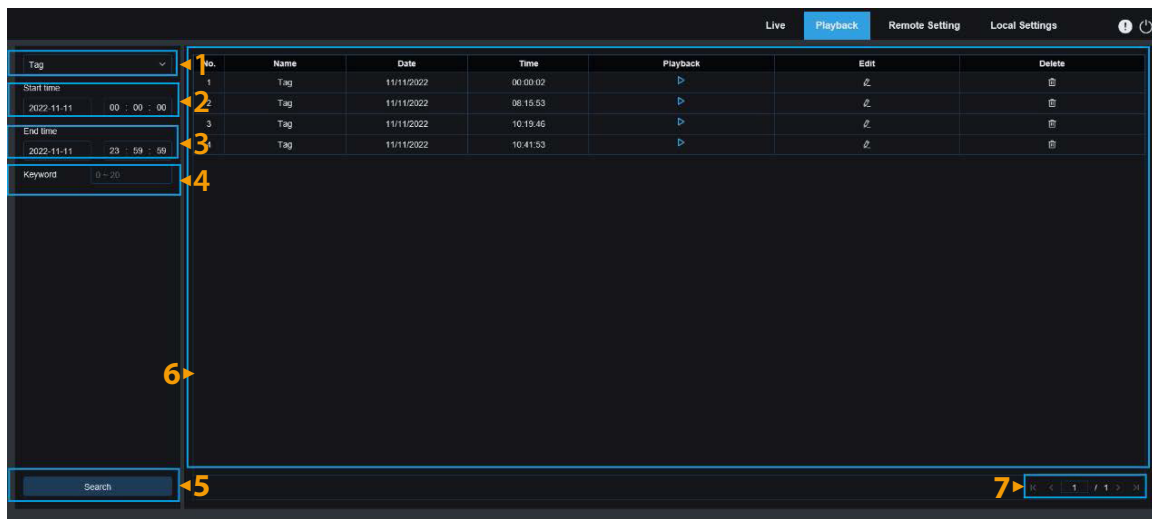
This screen allows you to view, edit, play or delete any tags you have previously added.



1. **Search Mode Switch:** Used to switch the current search function. The current search mode is Tag.
2. **Start Time:** Used to set the start time for searching for tags.
3. **End time:** Used to set the end time to search for tags.
4. **Keyword:** Allows you to search for tags using keywords.
5. **Search:** Click Search to start the search.
6. **Display search results:** Displays the desired search results.

Click  to play back events, click  to change the event name, click the save button to display the Modify Success prompt dialogue box, and click  to delete this event.

7. **Scrolling through search results:** You can scroll through the search results in the bottom right corner.

## 7.4 - Smart





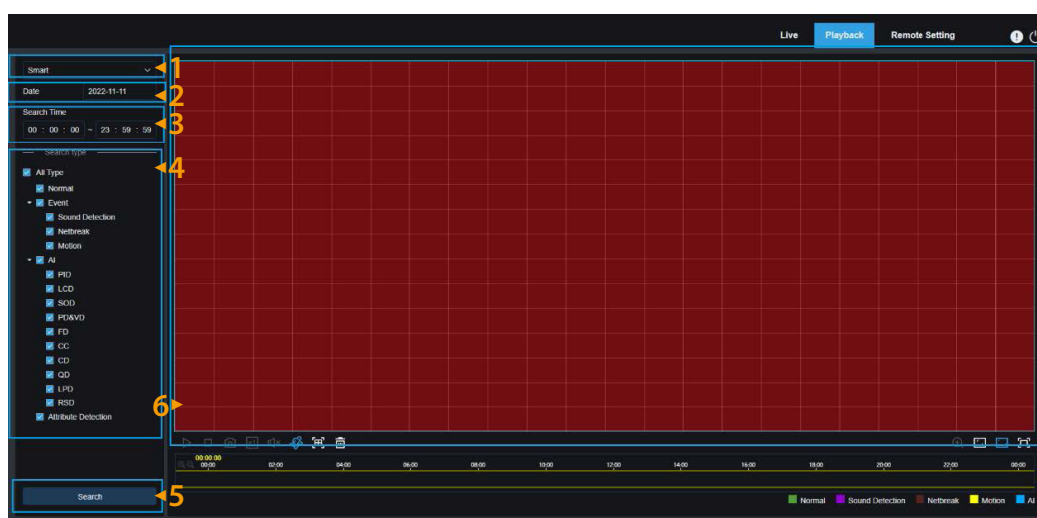

Log in from a browser without the need for a plug-in to start smart playback, as shown below:

EN



This feature can detect if an alarm has been triggered by a person in everyday life. If this is the case, the alarm will be displayed in blue in the playback time bar at the bottom.

1. **Search Mode Switch:** Used to switch the current search function. The current search mode is Smart.
  2. **Date:** Used to set the date to search for Smart Events. When you click Search, you will be prompted with the dates for which recorded files are available.
  3. **Search Time:** Used to set the time to search for events to make it easier to search.
  4. **Search Type:** Displays the search types supported by the camera. If required, you can search for only part of the recorded files.
  5. **Search:** Click Search to start the search.
  6. **Search results display area:** Displays the desired search results.
- Pause/Play:** Used to pause/play streams.
  - Stop:** Used to stop streams.
  - Capture:** Allows you to manually capture the picture of the current stream.
  - Speed:** Supports 1/8, 1/4, 1/2, 1, X2, X4, X8 and X16 speed playback.
  - Audio:** Allows you to turn on/off or adjust the sound of the stream.
  - Add Default Tag:** Used to add default tags. Highlight the video playback start time at the current time in the current channel and click this icon to add tags.
  - Add Tag:** Used to add custom tags. Clicking this icon to add a tag will bring up a custom window where you can enter a name for the tag.

-  **Smart:** Click this icon to access the Smart Area settings screen.
-  **All:** Click All to set the entire screen as the Smart Area.
-  **Delete:** Click Delete All to clear the entire area.
-  **Digital Zoom:** Allows you to zoom in on a specific area of the stream.
-  **Original Proportions:** Displays the current live view in its original proportions.
-  **Stretch:** Displays the current live view in a way that stretches the display area.
-  **Full Screen:** Displays the playback stream in full screen. You can double-click the screen to enable or disable the feature, and press Esc to exit Full Screen mode.

## 7.5 - AI

### 7.5.1 - Face Search & Playback

EN

The camera performs face recognition, stores the obtained face information on the TF card, and saves the image-related information. You can quickly retrieve captured faces that meet user requirements and easily locate related videos. The face search and playback screen is shown below.

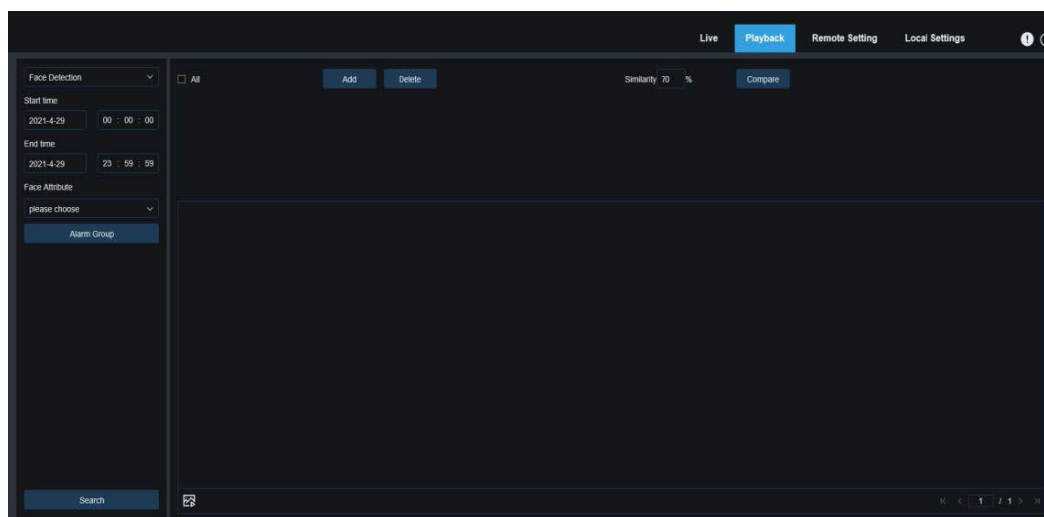

**Search Mode Switch:** Toggles the current search function. The current search mode is AI Face Detection.

**Start Time:** Set the start time to search for captured faces.

**End time:** Used to set the end time for searching for captured faces.

**Face Attribute:** The Face Attribute box is unchecked by default. If this box is checked, only face images captured when the face attribute detection function is started will be searched. The program can detect five face attributes, including gender, age, mask, glasses and expression.

**Alarm group:** When face images are captured, the camera assigns them to the corresponding group according to the settings in the face database. This setting allows you to search for images of only the desired groups.

**Search:** Search for faces according to the settings.

**Add:** Add images to the Viewer for comparison. You can add local images and captured images.

**Delete:** Delete the currently added images.

**Similarity:** Sets the lowest similarity of feature values of matching faces when using the Compare function.

**Compare:** Searches for captured faces according to the set search time, the group in which the captured group in which the captured images are located, and the selected reference face image for comparison.

**Add image display area:** Displays images currently being added and available for comparison.

**Search result display area:** On the right, displays captured images that have been searched for using Search and Compare. Double-clicking an image will play the video before and after the image.

## 7.5.2 - Human & Vehicle Search & Playback

Similar to the Face Detection function, the camera can differentiate between people or vehicles and record them according to your requirements. The screen is shown in the figure below.

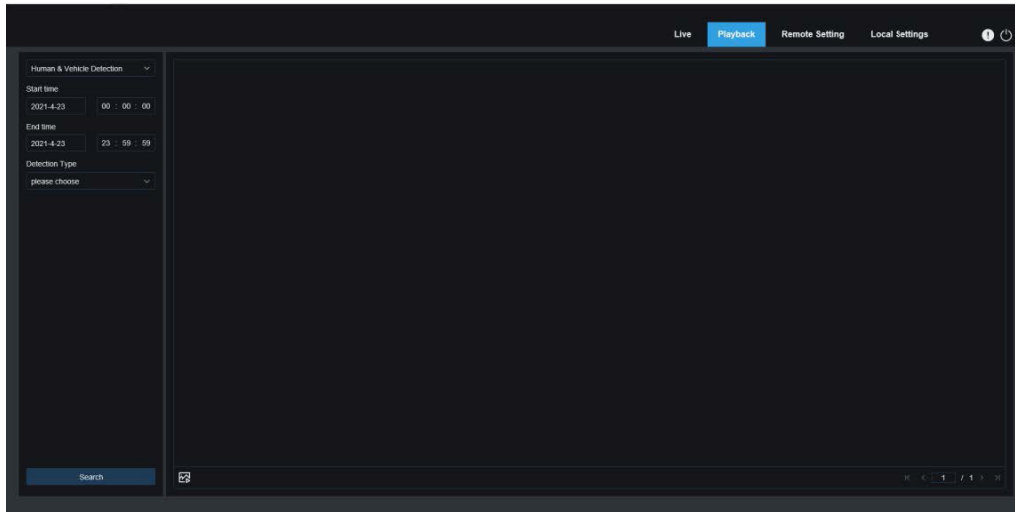

**Search Mode Switch:** Toggles the current search function. The current search mode is AI Human & Vehicle Detection.

**Start Time:** Used to set the start time for searching for people and vehicles.

**End Time:** Used to set the end time for searching for people and vehicles.

**Detection type:** Allows you to select people or vehicle images, or both, as required.

**Search:** Allows you to search for people and vehicles according to the search settings.

**Search result display area:** Displays the desired search results. Double-clicking an image will play the video before and after the image.

**Search result scrolling:** Allows you to scroll through the search results in the bottom right corner.

### 7.5.3 - PID & LCD

With the development of technology, AI PID&LCD can not only detect objects in the warning area, but also provide the human and vehicle detection function, which detects only human or vehicle objects, and record image or video information for easy retrieval and viewing. The screen is shown in the figure below.

EN

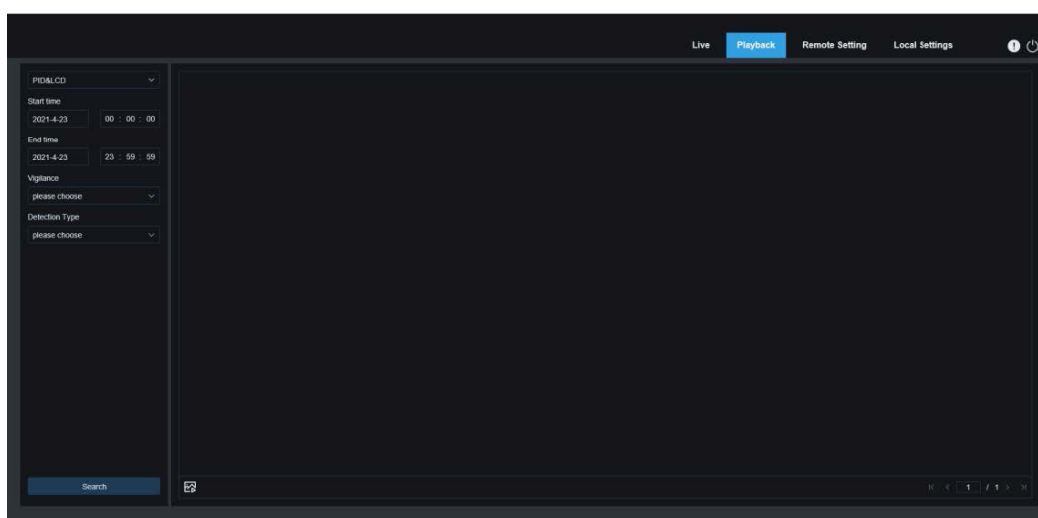

**Search Mode Switch:** Used to switch the current search function. The current search mode is AI PID&LCD.

**Start Time:** Used to set the start time for searching people and vehicles.

**End Time:** Used to set the end time for searching people and vehicles.

**Vigilance:** Used to select PID or LCD or both as the detection method.

**Type of detection:** Allows you to select human or vehicle images as required, or both.

**Search:** Allows you to search for people and vehicles according to the search settings.

**Search result display area:** Displays the desired search results. Double-clicking an image will play the video before and after the image.

**Search result scrolling:** Allows you to scroll through the search results in the bottom right corner.

## 7.5.4 - Repeat Customer Detection

The face recognition function can not only provide real-time alerts, but also dig deep into data to meet customer needs. For example, for the repeat customer detection function, a camera is installed in a certain area of the mall.

With the repeat customer detection function, you can check if a customer stops in that area to check out products. You can also monitor an area to see if a suspected target is frequently seen in that area. The repeat customer function screen is shown in the figure below.

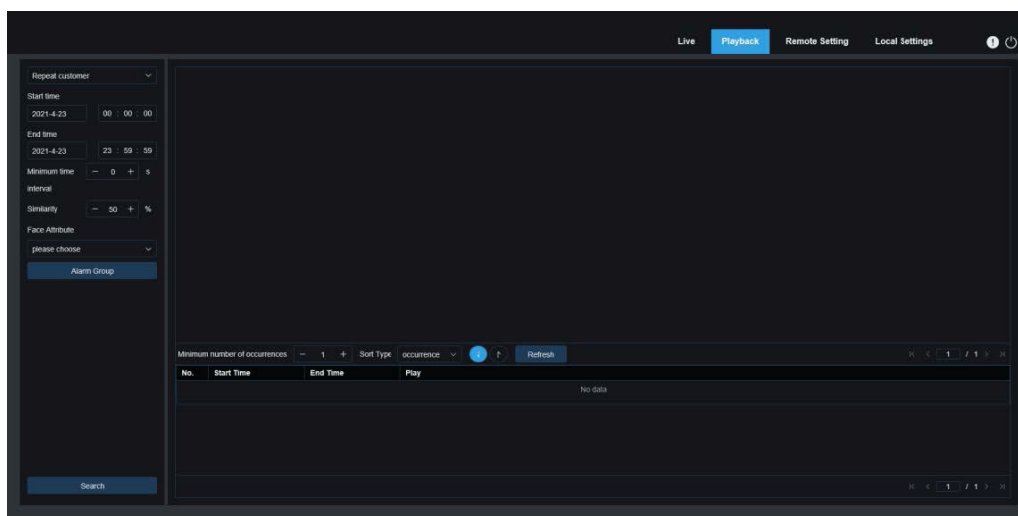

**Search Mode Switch:** Used to switch the current search function. The current search mode is AI Repeat Customer.

**Start Time:** Used to set the start time for searching for people and vehicles.

**End time:** Used to set the end time for searching people and vehicles.

**Minimum time interval:** Used to set the minimum time interval between capturing the same object twice to increase search accuracy.

**Similarity:** Used to set the lowest similarity between other images and the reference image when matching repeat customers.

**NOTE:** This setting takes effect only when Alarm Group is unchecked for the current function.

**Face Attribute:** Used to filter searched images according to face attribute values.

**NOTE:** The search will be applied on all images when this option is not set. When this option is set, only captured images with Face Attribute enabled are searched.

**Alarm Group:** Used to identify repeat customers according to group settings in the database.

**NOTE:** All images will be searched when no group limitations are set. In this case, the similarity setting takes effect. Stranger information will be ignored when group limitations are set.



**Search:** Used to search for information in recorded images according to settings.

**Search result display area:** Displays the search results in a stacked manner. Double-clicking on the displayed image information will list the stacked images at the bottom, and clicking on the corresponding image again will jump to its quick playback.

EN

**Minimum number of occurrences:** Used to filter search results by number of occurrences. You will need to click Refresh to update the display.

**Sort Type:** Allows you to sort search results chronologically or by number of captures in ascending or descending order. You must click Refresh to update the display.

**Refresh:** Refreshes the sorting in your IE by Minimum Number of Occurrences and Sort Type.

**Secondary search results display area:** Displays captured images of selected items in the form of an event list according to the information selected in the Search Results Display pane. You can click the Play button to go to quick playback.

## 7.5.5 - Face Attendance

In addition to the Repeat Customer function, the Face Recognition function also provides the Face Attendance function. The Face Attendance (FA) function is used to retrieve the face matching status in different groups (excluding the Stranger group) stored in the memory card in a specified period, and to generate an attendance result according to the shooting records. The operation screen is shown below.

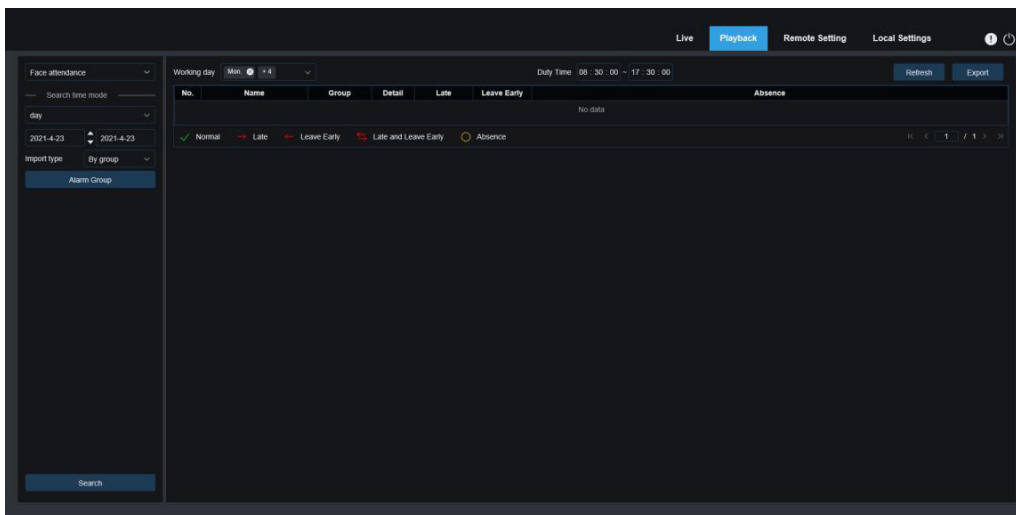

**Search Mode Switch:** Used to switch the current search function. The current search mode is AI Face Attendance.

**Select time mode:** Options include Day, Week, Month, Custom and Today. After selecting a type, the system will automatically change the start and end dates. Selecting Day will automatically synchronise the end and start dates. Selecting week automatically sets the starting and ending dates as the Monday and Sunday of the week in which the chosen day falls. If month is selected, the starting and ending dates are automatically set for the first and last days of the month. If Custom is selected, the search date can be customised. If Today is selected, the start and end dates are changed to the current date.

**Start Date:** Used to set the start date for the Face Attendance search.

**End Date:** Allows you to set the end date for the Face Attendance search.

**Import Type:** Used to select the type of import, including by group and by face. The first will use all people in the existing group as discovery objects to search for matching results. The last selects people in a specific group to search for matching results.

**Alarm Group:** When By Group is selected, face attendance results are searched by groups in the database.

When **By Face** is selected, the screen changes to the menu shown here.

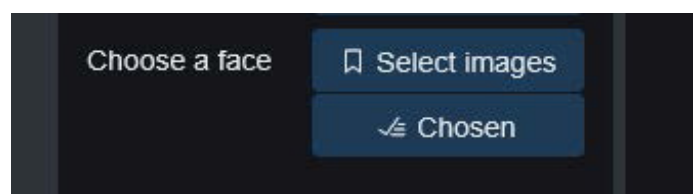

**Select images:** Select and click on the face image to be detected. The window shown below will appear.

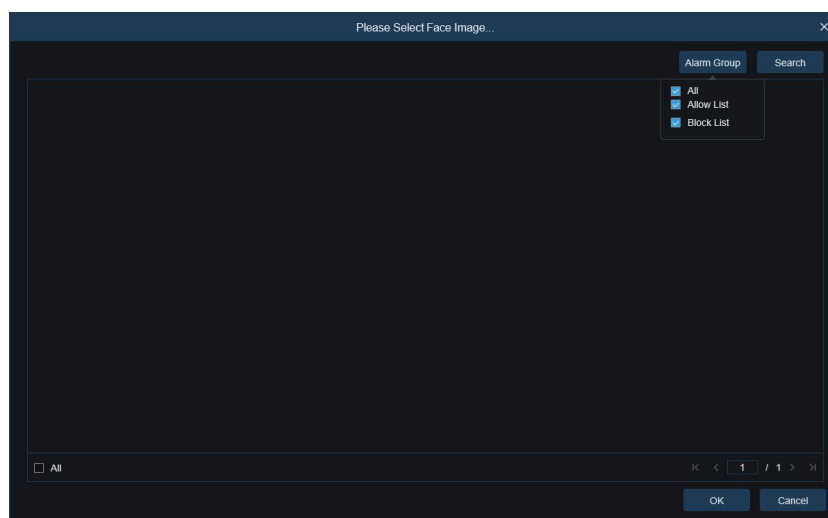

EN

Click **Alarm Group** to select a group, then click Search again to search for all face images in that group. Select the facial image for face attendance detection and click **OK**. The face image is added to the **Chosen** list. You can click **Cancel** to close this window.

**Chosen:** Displays a list of selected face images. You can click Chosen to display the window shown in the figure below.

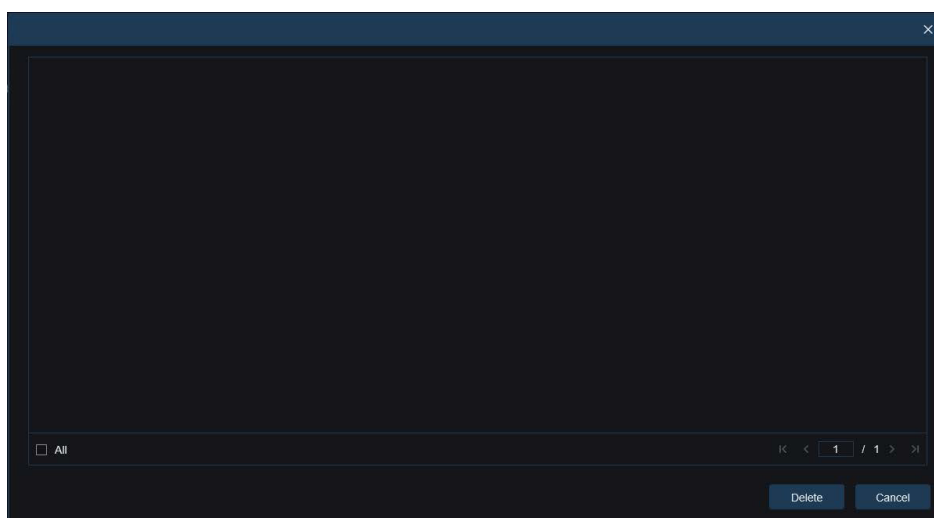

Select a face image and click **Delete**. The face image is deleted from the list. You can also click **All** to select all face images. You can click **Cancel** to close this window.

**Search:** Allows you to search for face attendance information according to the settings.

**Search result display area:** Displays search results in a table at the top right, as shown on the next page.

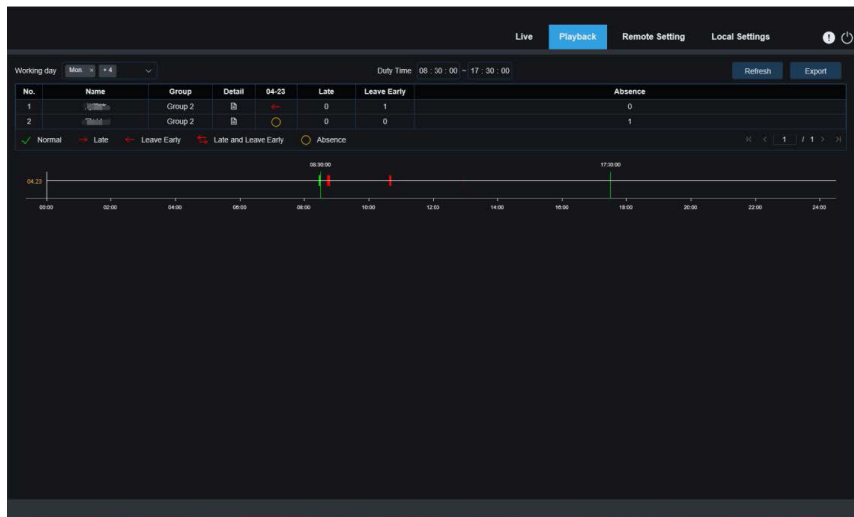

**Working day:** You can set the working day here.

**Duty Time:** You can set the working time here.

**Refresh:** After changing the attendance parameters, you can click Refresh to update the search results.

**Export:** You can click Export to export the results to your PC.

**Attendance results:** "←" indicates early, "→" late, both late and early, "√" normal attendance and "○" absence. The green lines indicate the start and end times of attendance.

**Secondary search results display area:** Clicking on a person will display detailed time information at the bottom right. The time corresponding to this person is marked with a red bar. Clicking on the red bar will take you to the corresponding quick replay.

You can click the **Detail** icon to check the details. You can click the **playback** icon to go to the quick replay.

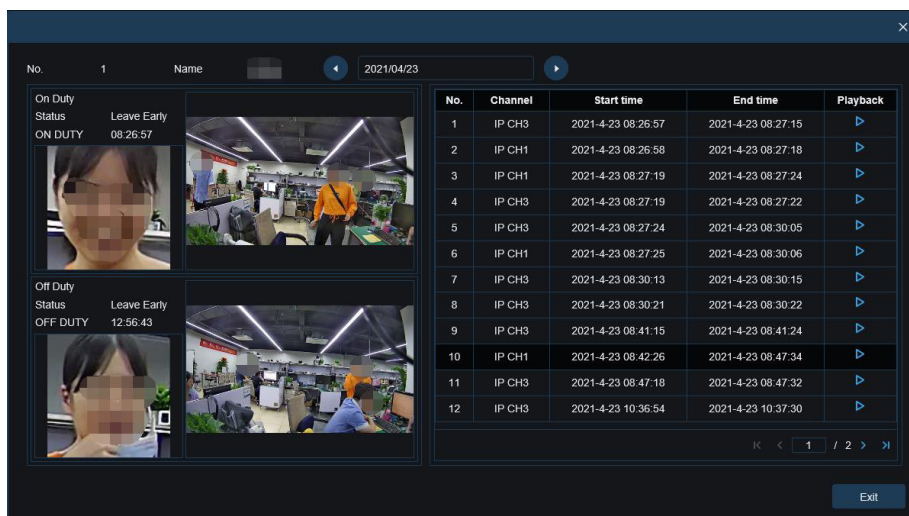

You can click the arrow in the bottom right corner to scroll through the results.

## 7.5.6 - License Plate Detection

When the licence plate detection function is enabled for the IPC, an alarm is triggered for recognised licence plates and images or video are recorded for easy search and viewing. The screen is shown below.

EN

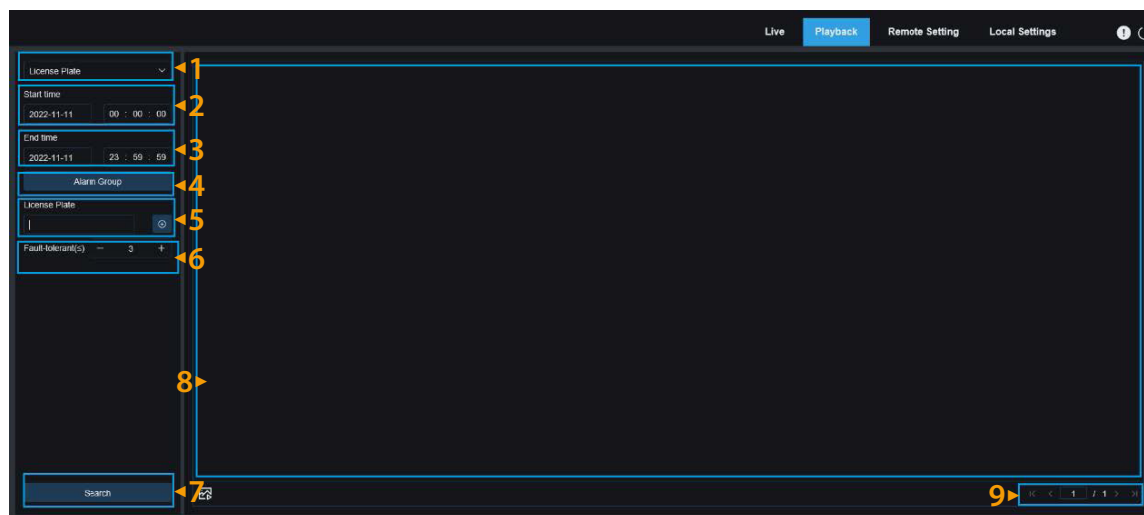

1. **Search Mode Switch:** Used to switch the current search function. The current search mode is License Plate.
2. **Start Time:** Used to set the start time to search for captured license plates.
3. **End Time:** Used to set the end time of the license plate search.
4. **Alarm Group:** Used to recognise license plates by groups in the database.

**NOTE:** All images are searched if no group restrictions are set. In this case, the similarity setting is used. Unknown licence plates are ignored if group limits are set.

5. **License Plate:** Used to filter and query licence plates.
6. **Fault Tolerant:** Fault tolerant rate. For example, three characters are set as query criteria. If the license plate is B594SB in the allow list in the group, an alarm will also be triggered when the vehicle with the license plate B734KB approaches the monitoring area. This means that a license plate with 0-3 characters different from the one in the database will be recognised.
7. **Search:** Allows you to search for recorded license plates according to the settings.
8. **Search result display area:** Displays the desired search results. Double-clicking an image will play the video before and after the image.
9. **Search result scrolling:** Allows you to scroll through the search results in the bottom right corner.

## 7.6 - Exported Video File

The exported video file(s) are optionally password protected and contain checksums to detect file manipulation.

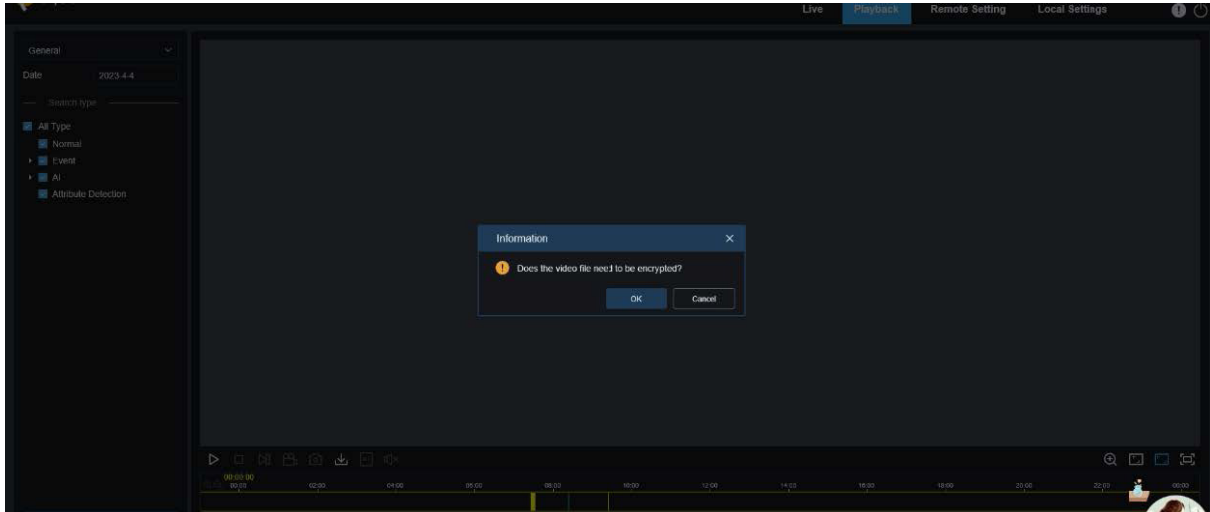

1. When you find the video files you want to download, click  to download the video file, the prompt "Does the video file need to be encrypted" will appear on the screen.
2. Click **OK** to go to the following menu.

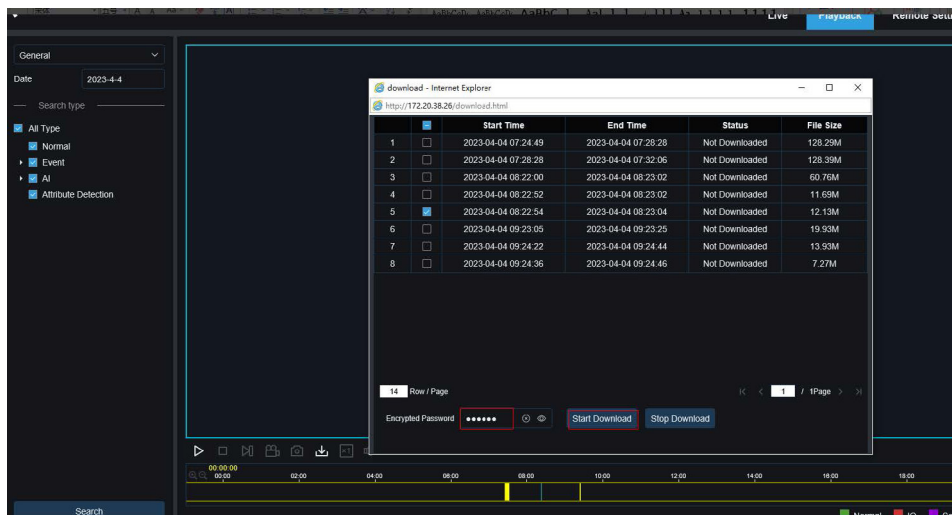

3. Set the password and click the **Start Download** option.

## 8 - REMOTE SETTING

### 8.1 - Live View

EN

In the live view, you can set the channel name, device time, CC, as well as statistical data and image coverage. The view is shown below.

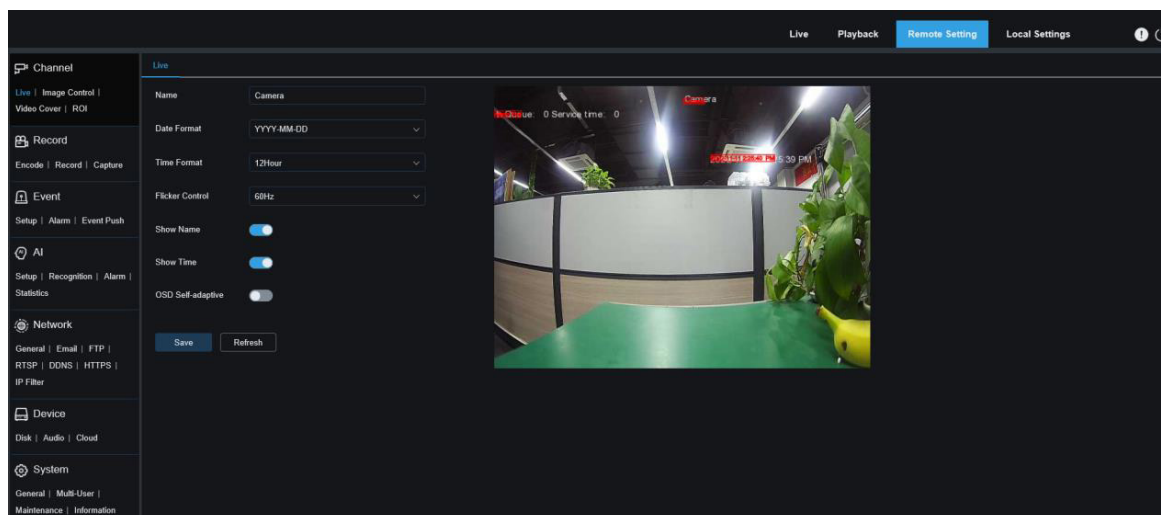

**Name:** Sets the channel name of the camera displayed on the OSD.

**Date Format:** Allows you to set the date format of the camera displayed on the OSD, including MM/DD/YYYY, YYYY MM DD, and DD/MM/YYYY.

**Time Format:** Allows you to set the time format of the camera displayed on the OSD, including 12-hour and 24-hour.

**Flicker Control:** Allows you to set the image refresh rate, including 60 Hz and 50 Hz, corresponding to N and P respectively.

**Show Name:** Allows you to set whether or not to display the channel name on the pictures.

**Show Time:** Allows you to set whether to display the channel time on the pictures.

**OSD Self-adaptive:** The OSD font colour of the camera time and channel name is self-adaptive. The colour changes between white and black based on the image background to ensure a clear display.

**Channel Name Display Location:** Allows you to set the location where the channel name will be displayed by dragging its position on the image.

**Time Display Location:** Allows you to set the location where the channel time appears by dragging its location on the image.

**Alarm Statistics Display Location:** Allows you to set the location where the alarm statistic appears by dragging its location on the image. This setting is only available when the alarm statistics display function is enabled.

**Save:** Allows you to save the current changes.

**Refresh:** Refreshes the parameters of the current view.

## 8.2 - Image Control

Image control is to directly control and modify graphic parameters, such as colour to black mode, wide dynamic range, backlight compensation, etc. The view is shown in the figure below.

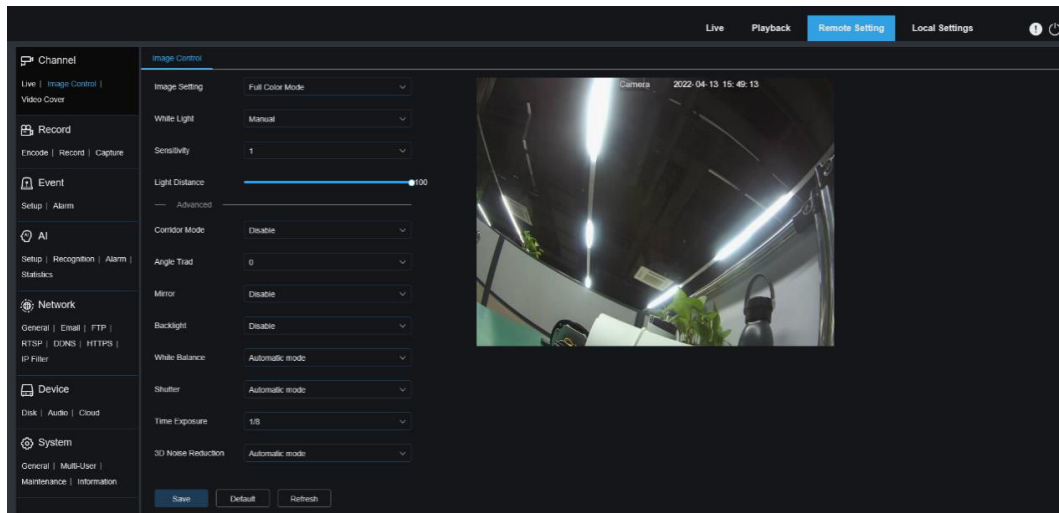

**Image Setting:** Used to set Camera Mode. There are three mode options.

1. **Full Colour Mode:** The camera works in Full Colour Mode.
2. **Day/Night Mode:** The camera works in Day/Night Mode.
3. **Schedule:** The camera works in schedule mode. The Full Colour Mode and Day/Night Mode will be switched as scheduled.

**White Light:** Used to set the fill in light for the white light in Full Colour Mode. There are four mode options.

1. **Automatic mode:** In Automatic Mode, the camera automatically adjusts the intensity of the fill in light according to ambient illumination.
2. **Manual:** In Manual Mode, the fill in light is applied on the environment with a fixed brightness value.
3. **Schedule:** In Schedule Mode, the white light is automatically switched on and off for fill in as scheduled.
4. **OFF:** Used to turn off the white light.

**Sensitivity:** Sensitivity 0-3. The degree to which the camera is sensitive to ambient light. The higher the value is, the higher the sensitivity is.

**Light Distance:** Ranging from 0 to 100 and used to adjust the brightness of the fill in light. The higher the value is, the higher the brightness is.

**IR CUT Mode:** Used to set the day/night switching mode of the camera in Day/Night Mode. There are five mode options.

1. **Auto:** Used to automatically control the Switching mode. Among them, colour to b/w is judged by images and b/w to colour is judged by light sensitivity to ambient light.



2. **Day:** Forced Colour mode will not be switched to b/w.
3. **Night:** Forced B/W mode will not be switched to colour.
4. **Image:** Similar to the Auto Mode, colour to black and black to colour are judged by images (for non photosensitive models).
5. **Schedule:** Used to switch between b/w and colour as scheduled. If this function is enabled, the start time and end time for night vision shall be set.

**IR CUT Delay:** Used to switch day/night for the Automatic Mode and Image Mode. The day/night switchover delay is adjustable from 1s to 36s. The day/night switchover is performed only when the ambient illumination meets switchover requirements and the retention time exceeds the preset threshold.

**IR LED:** Used to set the fill in light effect of the IR light at night vision. There are three mode options.

1. **SmartIR:** Used to intelligently control the fill in light intensity of the IR light according to focal length and overexposure condition.
2. **Manual:** Manual Mode in which the fill in light is applied in the form of the set brightness of the IR light.
3. **OFF:** No fill in light is applied for any light.

**Low Beam Light:** Here, you can manually adjust the brightness of the IR light (0 to 100, of which 0 indicates that the IR light is off and 100 indicates the highest brightness).

**Corridor Mode:** Corridor Mode.

**Angle Trad:** Image rotation setting. The camera is reverse to the presetting in some usage scenarios. For example, the camera is designed to be hung upside down, but in practice it is used flatwise. You can set this value to adjust the image.

**Mirror:** You can set the mirror mode to adjust the picture effect. There are four mode options.

1. **Disable:** Used to disable the Mirror Mode.
2. **Vertical:** Used to set the Mirror Mode in the vertical direction to interact the image on the picture up and down.
3. **Horizontal:** Used to set the Mirror Mode in the horizontal direction to interact the image on the picture left and right.
4. **All:** Used to enable Vertical and Horizontal at the same time. The effect is similar to that of 180° rotation, but the implementation principle is different.

**Backlight:** Used to set the performance of the program when the backlight is turned on. There are four mode options.

1. **WDR:** Wide dynamic range in which the picture is uniformly balanced based on the setting and both light and dark areas can be clearly distinguished.
2. **HLC:** Highlight compensation in which the objects in the highlighted area are clearer in the picture. (Applicable for some models).
3. **Back Light:** Backlight compensation in which the objects in the dark area are more clearer.
4. **Disable:** An image will not be optimized with backlight on.

**White Balance:** White balance is a measure of the accuracy of white produced by mixing red, green, and blue. There are two mode options.

1. **Automatic mode:** Allows you to adjust the white light using default parameters.
2. **Manual:** Allows you to actively set the synthetic gained white light of red, green, and blue.

**Shutter:** Used to set the shutter exposure time. There are two mode options.

1. **Automatic mode:** The program automatically selects a proper exposure time according to the Time Exposure setting.
2. **Manual:** Allows you to directly use the Time Exposure setting.

 **NOTE:** Deselect the flicker less option of the exposure time in shutter manual mode, and select the option in shutter auto mode. If you switch the shutter to manual mode, the exposure time is switched automatically to 1/100 or 1/120.

**Time Exposure:** Used to set the exposure time of the camera and use this parameter in combination with Shutter. When the exposure time is too long, there may be overexposure. When the exposure time is too short, the picture may be dark.

**Defog:** Foggy days will lead to deteriorated images. The defog function can optimize image rendering in foggy days. There are three settings:

1. **OFF:** Used to disable the defog function.
2. **Automatic mode:** In this mode, the camera automatically judges the defog effect.
3. **Manual:** Allows you to manually set the defog value.

**3D Noise Reduction:** You can reduce image noise by setting this parameter to obtain a clearer picture. There are three mode options.

1. **Automatic mode:** In this mode, the camera will automatically select the noise reduction effect according to algorithms.
2. **OFF:** Used to disable the noise reduction function.
3. **Manual:** Allows you to manually set the noise reduction coefficient to reduce image noise.

**Save:** Used to save parameter changes to an image.

**Default:** Used to restore image parameters to default settings.

**Refresh:** Used to refresh image parameters.

## 8.3 - Video Cover

In practical applications, if areas that can be monitored by the camera are not suitable for monitoring and recording, you can use this function to occlude these areas. The screen is shown in the figure below.

EN

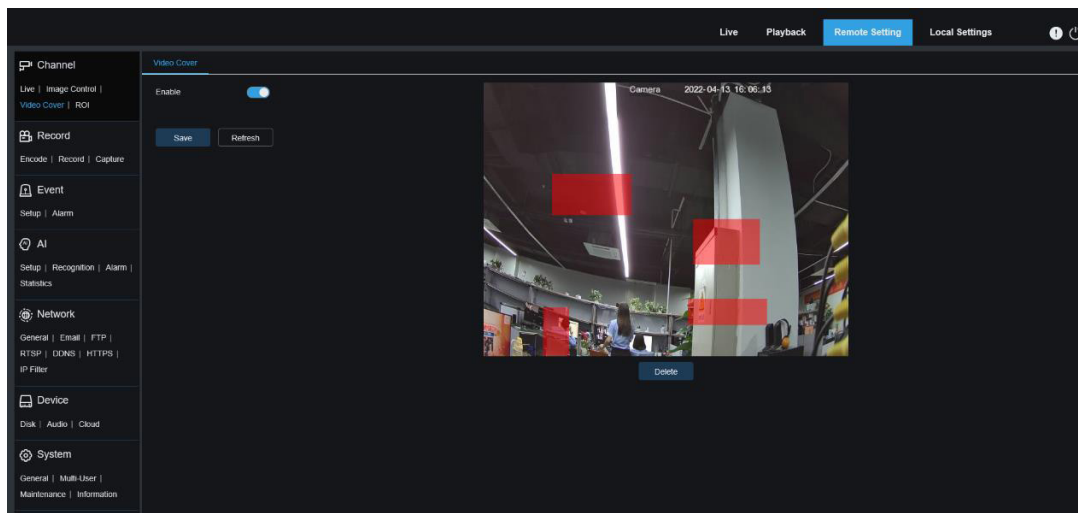

**Enable:** Used to enable the video tampering function.

**Cover Area Setting:** Used to set the areas to be tampered in the monitoring screen. The tampered blocks are red while setting and will turn to black after they take effect. You can set four tampering blocks.

**Delete:** Used to delete selected tampering blocks.

## 8.4 - ROI

ROI (sensitive area) is a region of interest selected from the video area. This area can be set to a different frame rate and sharpness than the unselected area.

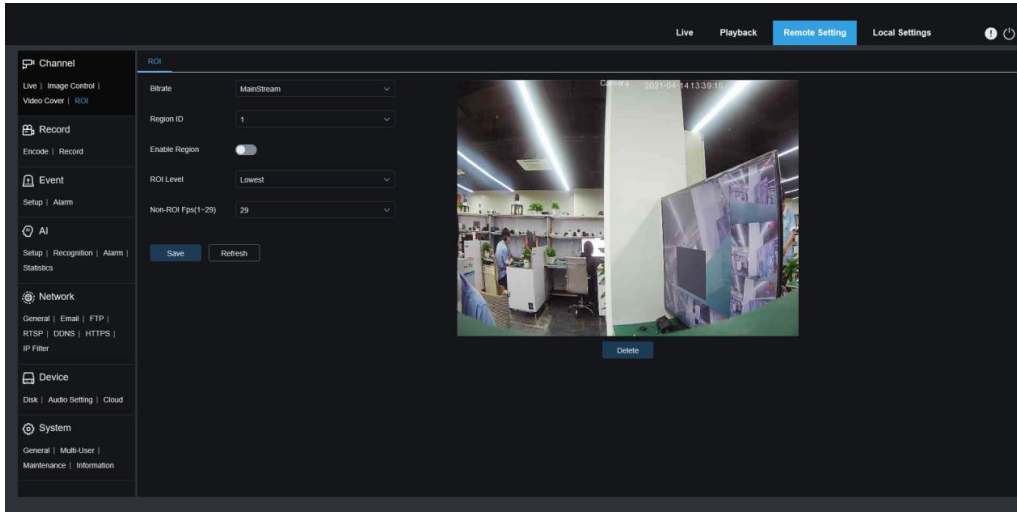

**Bitrate:** Used to select the bit rate to be set.

**Region ID:** Used to select region IDs. You can set up to eight regions.

**Enable Region:** Used to enable regions.

**ROI Level:** Used to set image quality in regions. The higher the quality is, the higher the resolution and frame rate are

**Non ROI Fps:** Used to set the frame rate of non region of interest. If the video code type is H264+ or H265+, the ROI function and the type are mutually exclusive. Therefore, the ROI function cannot be enabled, as shown in the following figure:

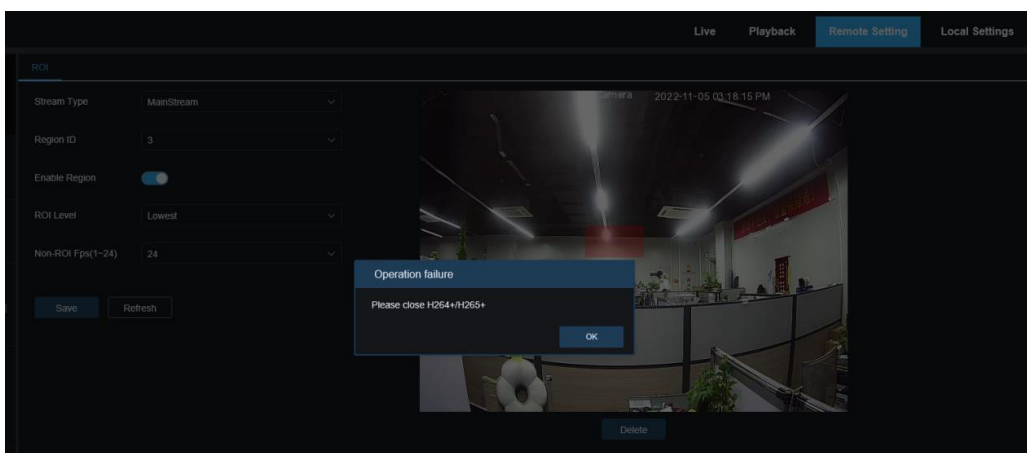

Enabling ROI does not take effect when the Substream is in MJPEG format.

**NOTE:** Some models support ROI function

## 8.5 - Recording Parameters

This menu allows you to configure preview parameters and recording parameters.

EN

### 8.5.1 - Encoding Parameters

This menu allows you to configure the image quality for video recording or network transmission. In general, **Mainstream** defines the quality parameters of recorded videos that will be stored in the HDD, **Substream** defines the quality parameters of live videos that are remotely accessed from for example the web client and CMS, and **Mobilestream** (can be turned off) defines the quality parameters of live views that are remotely accessed and viewed from mobile devices.

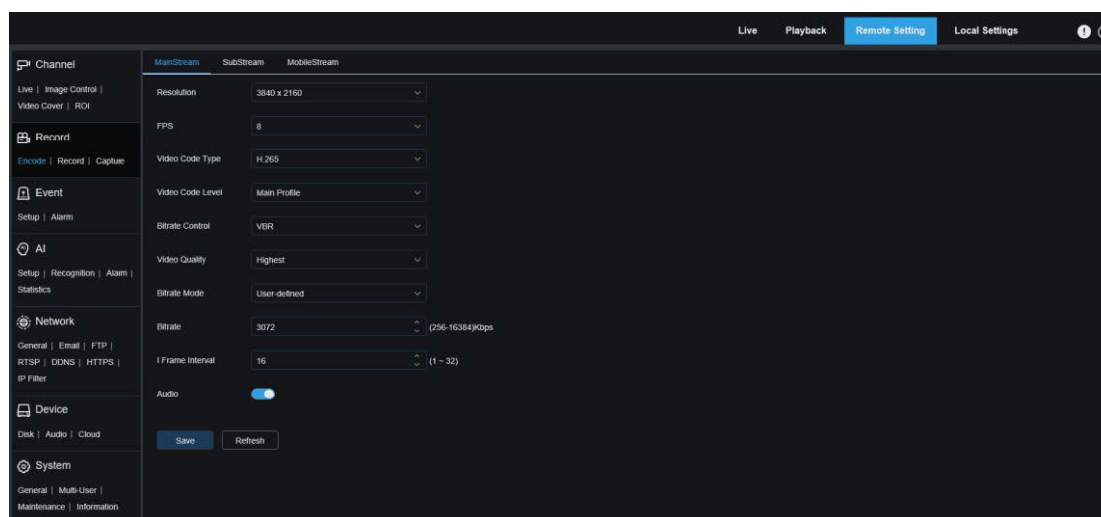

**Resolution:** This parameter defines the resolution of a recording

**FPS:** This parameter defines the frame rate of recording in your

**Video Code Type:** Channel decoding types. The options include H.264, H.265, H.264+, H.265+, and MJPEG (MJPEG only exists in sub stream mode).

**Video Code Level:** Video quality levels. The options include Best line, Main Profile, and High Profile (for H.265, only Main Profile is available).

**Bitrate Control:** Used to select a bit rate level. For a simple scenario such as a plastered wall, a constant bit rate is preferred. For a complicated scenario such as a busy street, a variable bit rate is preferred.

**Bitrate Mode:** To manually set a bit rate, select the "Custom" Mode. To select a preset bitrate, select the "Preset" Mode.

**Bitrate:** This parameter corresponds to the data transmission speed used by the IPC to record a video. Recording in a higher bit rate will gain better image quality.

**I Frame Interval:** Used to set an I frame interval. This option is only available in the IPC.

**Audio:** Select this option if you want to record both audio and video and connect your microphone to IPC or use a camera with audio capability.

## 8.5.2 - Recording Parameters

### 8.5.2.1 - Recording Parameters

This menu allows you to set recording parameters.

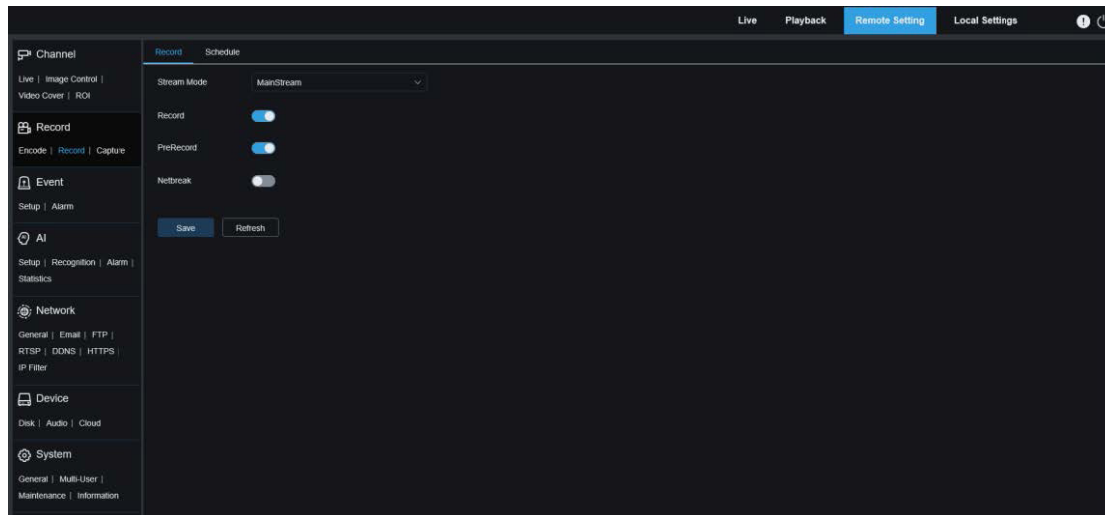

**Stream Mode:** Used to select a Recording Mode, that is, video stream to be saved in the memory card. The main stream is selected by default.

**Record:** Select this option to start

**Pre-Record:** If this option is enabled, the IPC will start recording a few seconds before an alarm event occurs. This option is recommended if your main recording type is based on motion detection or I/O alarm.

**Net-break:** If this option is selected, recording continues even when the network is disconnected or network failure occurs

## 8.5.2.2 - Recording Schedule

This menu allows you to specify when the IPC starting recording. You can set a recording plan in the recording schedule. The recording is performed only within the selected time period. You can drag your cursor to mark areas.

EN

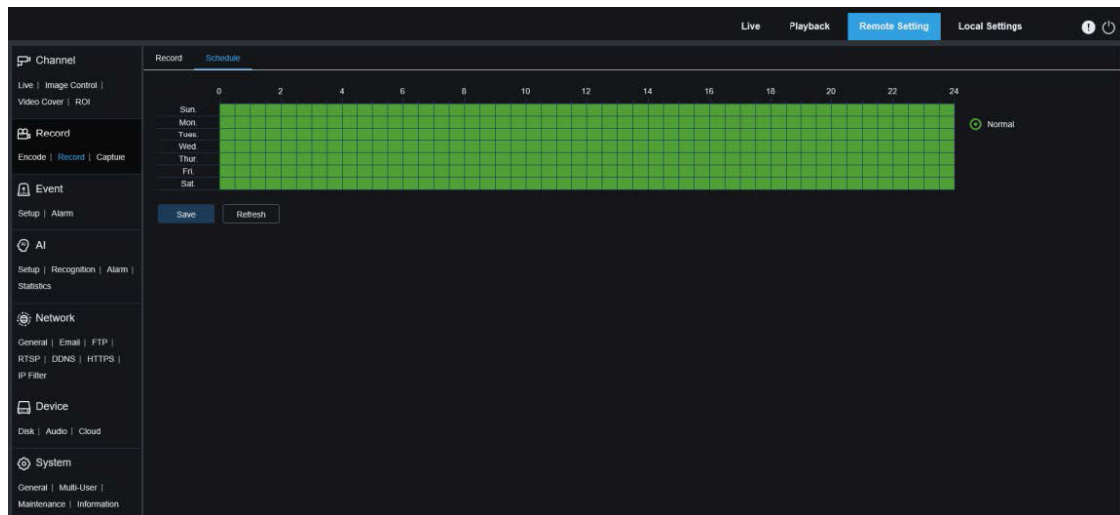

## 8.5.3 - Capture

### 8.5.3.1 - Capture Settings

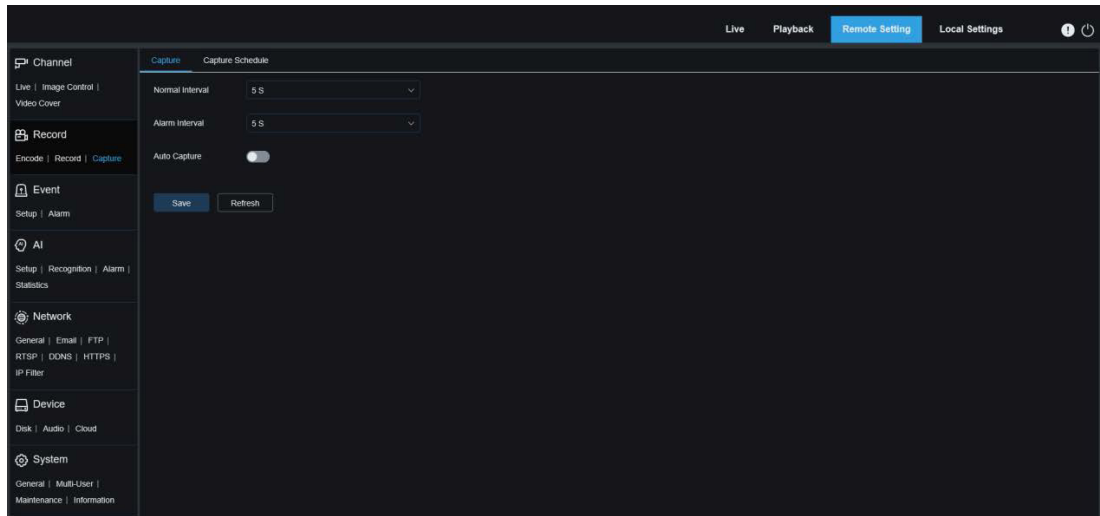

**Normal Interval:** Normal capture interval, used to specify the capture interval in normal recording.

**Alarm Interval:** Alarm capture interval, used to specify the capture interval when motion detection, I/O alarm, or PIR is triggered.

**Auto Capture:** Automatic



### 8.5.3.2 - Capture Schedule

This menu allows you to specify when the IPC capture images. You can set a capture plan in the capture schedule. The capture is performed only within the selected time period. You can drag your cursor to mark areas.

EN



**Normal:** When the area is marked green, the channel performs normal capture on the area in the corresponding time period.

**Motion:** When the area is marked yellow, the channel performs motion capture on the area in the corresponding time period.

**IO:** When the area is marked red, the channel performs I/O alarm capture on the area in the corresponding time period.

**PIR:** When the area is marked purple, the channel performs PIR alarm capture on the area in the corresponding time period.

**No Capture:** When the area is marked black, the channel will not perform capture in this time period.

## 8.6 - Event Setup

### 8.6.1 - Parameter Setup

#### 8.6.1.1 - Motion Detection

This menu allows you to configure motion detection parameters. When motion is detected, a series of alarms will be triggered, such as sending an email alert with attached images from the camera (if this option is enabled) and a push notification via the App.

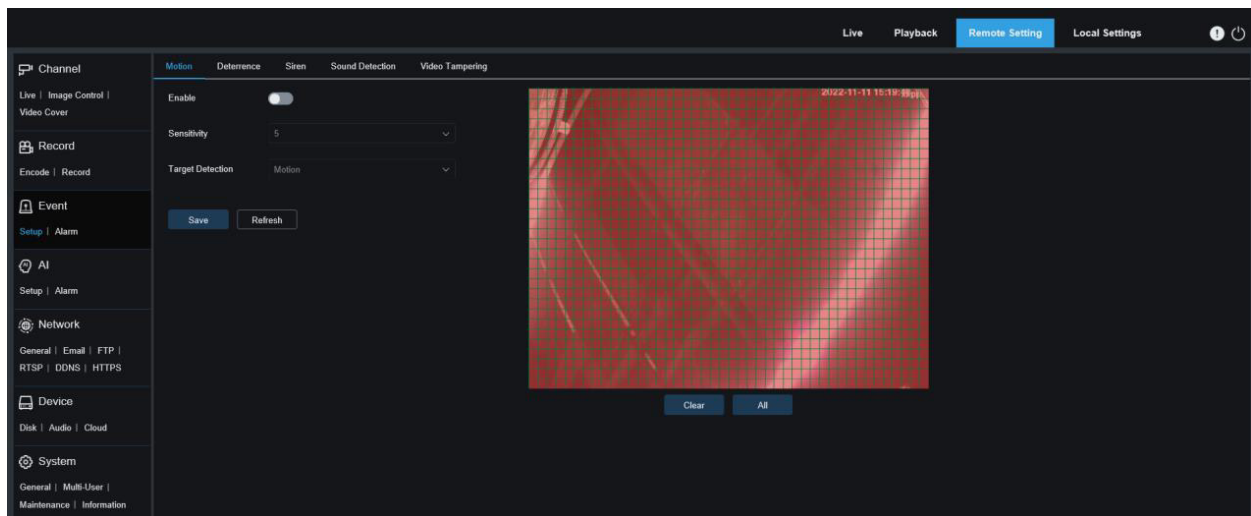

You can drag the left mouse button to delimit the detection area in the right window. An alarm will be triggered only when motion is detected in this area.

**Enable:** Used to enable or disable motion detection.

**Sensitivity:** Used to set the sensitivity of motion detection. The higher the value, the higher the sensitivity.

**Target Detection:** Intelligent motion detection . You can set the target detection type and area. The motion detected in the area can trigger an alarm. The detection type includes the following four options: Motion, Person , Vehicle, and Person Vehicle.

**NOTE:** Only some models support target detection.

## 8.6.1.2 - Sound Alarm

Used to set the response to sound alarm. An alarm will be triggered when the camera detects that the connected audio has changed and the requirement of alarm detection is met.

EN

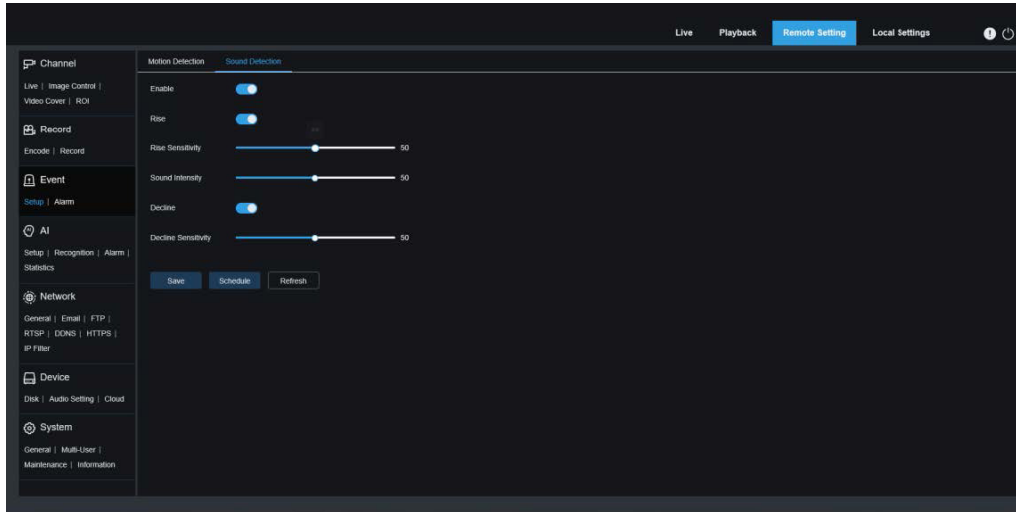

**Enable:** Used to enable or disable audio detection.

**Rise:** Volume rise switch. When this option is turned on, an alarm will be triggered only when the volume rises steeply.

**Rise Sensitivity:** Rise sensitivity. The higher the value, the easier it is to trigger an alarm.

**Sound Intensity:** Used to send sound intensity. This setting is the sound threshold. The larger the threshold, the louder the sound is required to trigger a rise alarm, and vice versa.

**Decline:** Volume decline switch. When this option is turned on, an alarm will be triggered only when the volume declines steeply.

**Decline Sensitivity:** Decline sensitivity. The higher the value, the easier it is to trigger an alarm.

**Schedule:** Used to set a sound alarm schedule. A sound alarm will be triggered only within the planned time.

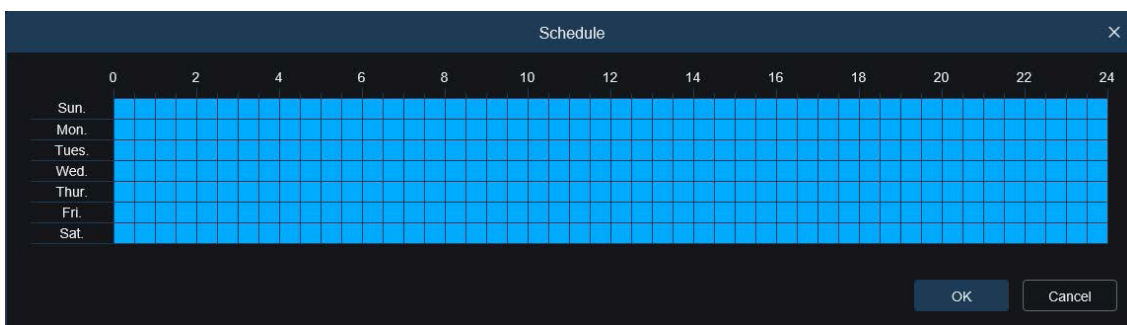

### 8.6.1.3 - White Light Deterrence

This menu allows you to configure white light deterrence parameters when the camera supports white light and the image control is set to Day/Night Mode. When the alarm linking to deterrence is triggered, the white light will be automatically turned on for deterrence purpose. As shown in the figure below:

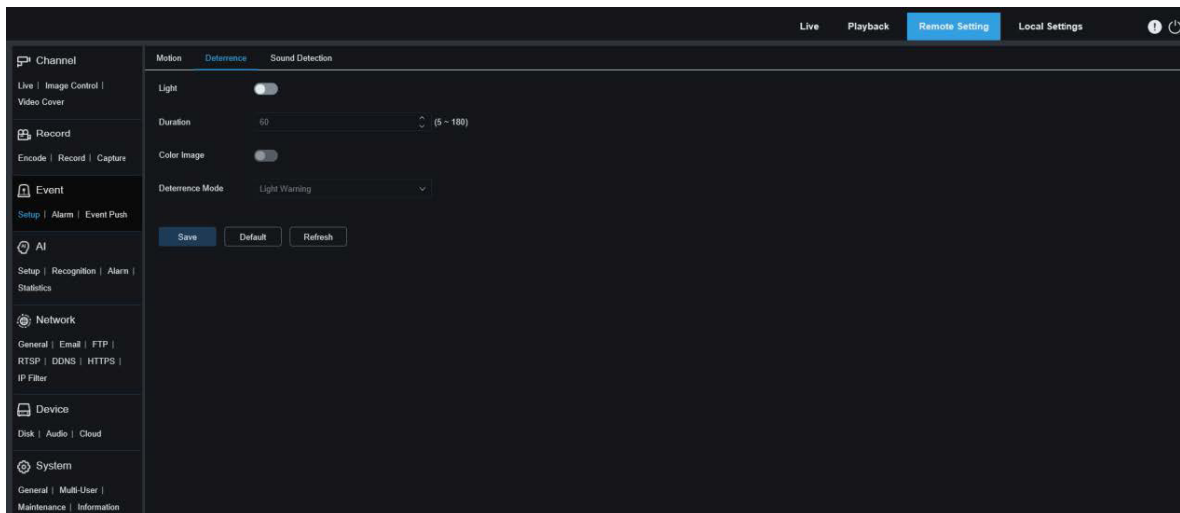

**NOTE:** When the camera supports white light and image control is set to Full Colour Mode, the white light parameters such as Light become unavailable; when image control is set to Day/Night Mode, all parameters on this screen are available.

**Light:** White light deterrence switch.

**Duration:** Used to set the duration of white light deterrence.

**Colour Image:** A switch used to determine whether to switch the image to colour mode when the white light deterrence is triggered. If this option is enabled, if you switch to the night vision mode in Day/Night Mode, when an alarm is triggered and white light deterrence is performed, the image will switch to the colour mode and not switch back to the night vision mode until the end of white light deterrence.

**Deterrence Mode:** White light Deterrence Mode. There are two mode options:

1. Light Warning: The white light is steady on during deterrence.
2. Light Strobe: The white light blinks at a set frequency during deterrence.

When the camera supports white light and warning light, you can set deterrence parameters on this screen. When an alarm linking to deterrence is triggered, the light can be turned on as configured. As shown in the following figure.

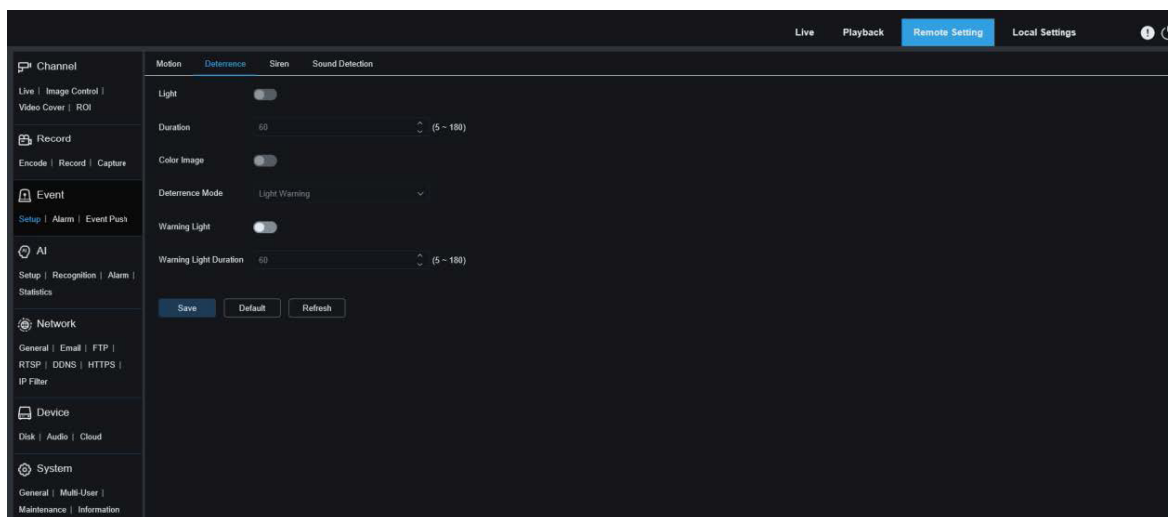

EN

**NOTE:** When the camera supports white light and image control is set to Full Colour Mode, the white light parameters such as Light become unavailable; when image control is set to Day/Night Mode, all parameters on this screen are available.

**Light:** White light deterrence switch.

**Duration:** Used to set the duration of white light deterrence.

**Colour Image:** A switch used to determine whether to switch the image to colour mode when the white light deterrence is triggered. If this option is enabled, if you switch to the night vision mode in Day/Night Mode, when an alarm is triggered and white light deterrence is performed, the image will switch to the colour mode and not switch back to the night vision mode until the end of white light deterrence.

**Deterrence Mode:** White light Deterrence Mode. There are two mode options:

1. **Light Warning:** The white light is steady on during deterrence.
2. **Light Strobe:** The white light blinks at a set frequency during deterrence.

**Warning Light:** Turn on or turn off warning light.

**Warning Light Duration:** Set the warning light duration.

### 8.6.1.4 - Siren Deterrence

When the PTZ camera supports siren, you can set siren deterrence parameters on this screen. When an alarm linking to deterrence is triggered, the siren is automatically turned on for deterrence purpose, as shown in the following figure.

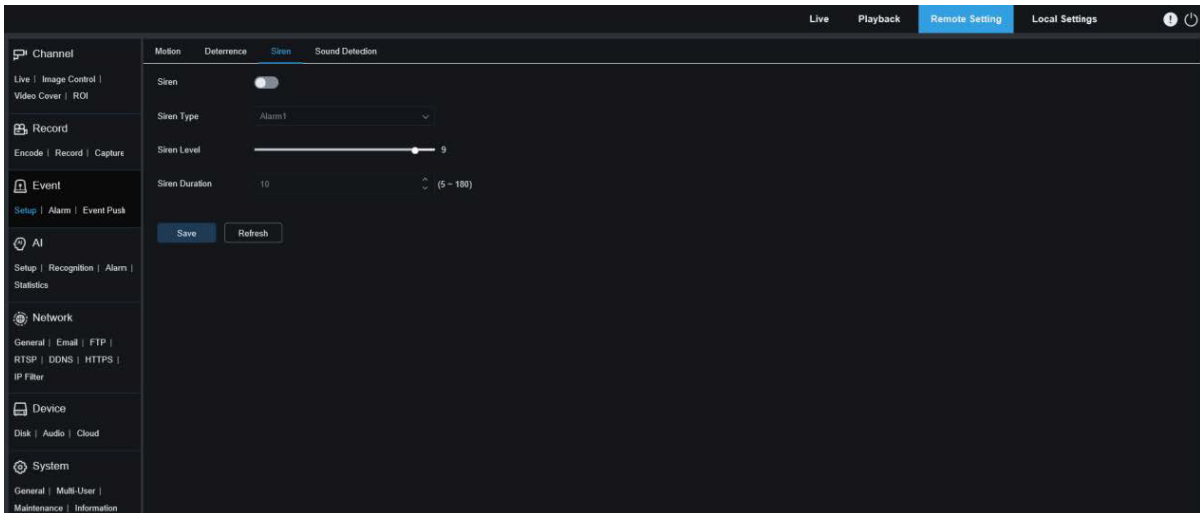

**Siren:** Used to turn on/off the siren.

**Siren Type:** Used to set the siren file type. By default, there are two files for users to configure. You can customize and import three siren audio files (the audio file format can be .wav and .pcm, and the file size is not larger than 256 K).

**Siren Level:** Used to set the siren level.

**Siren Duration:** Used to set the siren duration.

### 8.6.1.5 - Video Tampering Detection

Used to detect the live view tampering and trigger an alarm.

EN

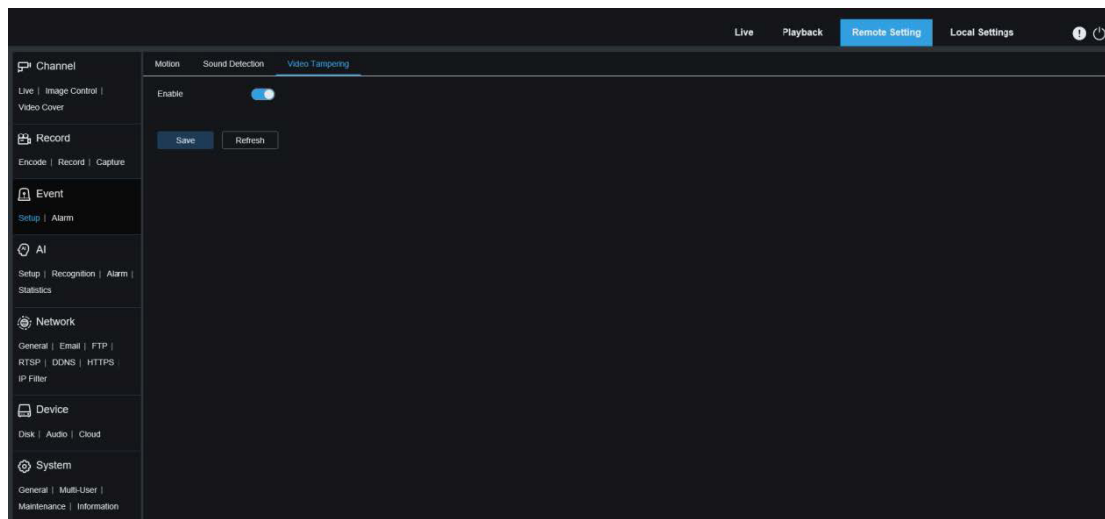

**Enable:** Used to enable or disable video tampering detection.

## 8.6.2 - Alarm Setting

This menu allows you to set the actions to be performed when an alarm is triggered.

### 8.6.2.1 - Motion Detection

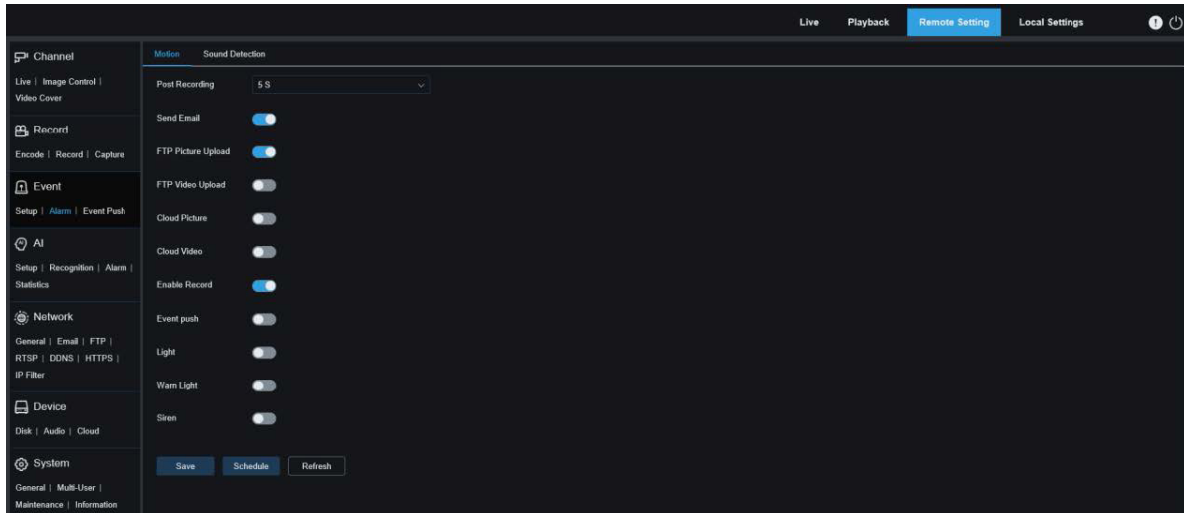

**Latch Time:** Used to set the duration for triggering an external alarm when motion is detected.

**Post Recording:** You can set the duration of continuous recording after an event occurs. The options include 5s, 10s, 20s, and 30s. The default duration is 5s, but the maximum duration can be set to 30s.

**Send Email:** You can have the device automatically send you an email when it detects motion.

**FTP Picture Upload:** Used to upload alarm pictures to the FTP server.

**FTP Video Upload:** Used to upload alarm videos to the FTP server.

**Cloud Picture:** Used to upload alarm pictures to the cloud platform for storage.

**Cloud Video:** Used to upload alarm videos to the cloud platform for storage.

**Alarm Out:** Optional. If your device supports connection to an external alarm device, you can turn on this switch to activate the external alarm device.

**Enable Record:** If this option is turned on, this kind of recording will be enabled when an alarm is triggered.

**Event push:** If this option is set to ON, this type of information will be pushed to the client when an alarm is triggered.

**Light:** If this option is set to ON, the white light will be turned on for deterrence when an alarm is triggered.

**Warn Light:** If this option is set to ON, the warning light will be turned on for deterrence when an alarm is triggered.

**Siren:** If this option is set to ON, the siren will be turned on for deterrence when an alarm is triggered



**Schedule:** Used to set the scheduled time when an alarm acts. A series of alarm actions are triggered only within the scheduled time.

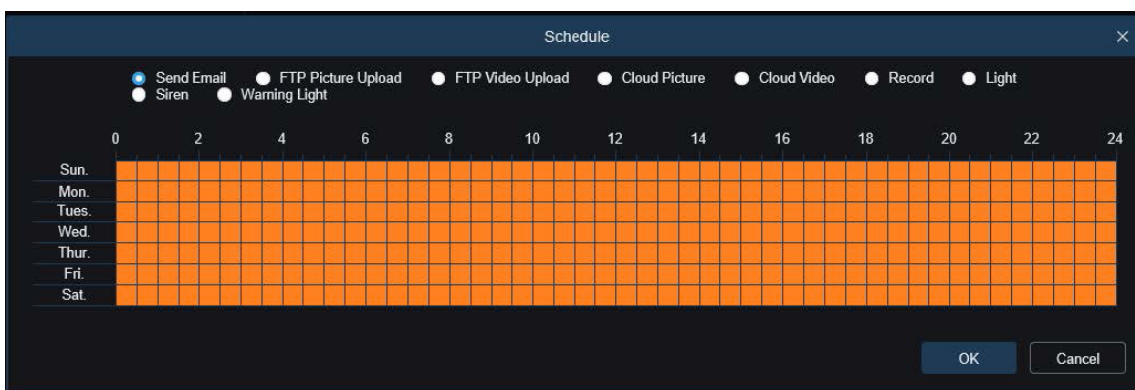

Schedule

Send Email     FTP Picture Upload     FTP Video Upload     Cloud Picture     Cloud Video     Record     Light  
 Siren     Warning Light

0    2    4    6    8    10    12    14    16    18    20    22    24

Sun.  
Mon.  
Tues.  
Wed.  
Thur.  
Fri.  
Sat.

OK    Cancel

## 8.6.2.2 - I/O - Alarm

This function is available only when your device supports I/O sensors and is connected to an external I/O alarm device.

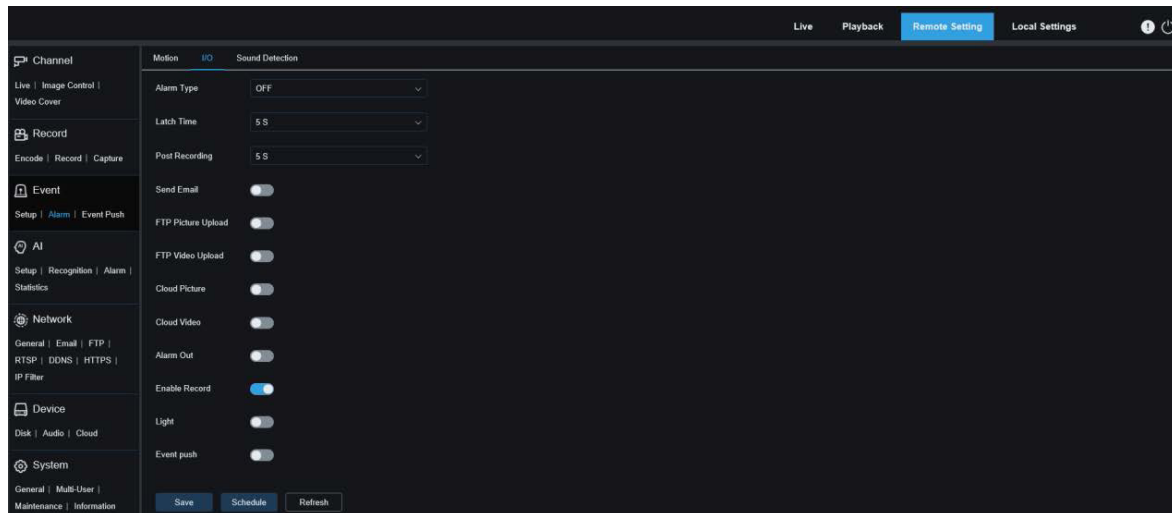

**Alarm Type:** You can select three alarm types: NO, NC, and Off. You can select a type that matches your sensor type, or select "Off" to turn off sensor triggering.

**Latch Time:** Used to set the duration for triggering an external alarm when an I/O alarm is triggered.

**Post Recording:** You can set the duration of continuous recording after an event occurs. The options include 5s, 10s, 20s, and 30s. The default duration is 5s, but the maximum duration can be set to 30s.

**Send Email:** You can have the device automatically send you an email when it detects an I/O alarm.

**FTP Picture Upload:** Used to upload alarm pictures to the FTP server.

**FTP Video Upload:** Used to upload alarm videos to the FTP server.

**Cloud Picture:** Used to upload alarm pictures to the cloud platform for storage.

**Cloud Video:** Used to upload alarm videos to the cloud platform for storage.

**Alarm Out:** Optional. If your device supports connection to an external alarm device, you can turn on this switch to activate the external alarm device.

**Enable Record:** If this option is turned on, this kind of recording will be enabled when an alarm is triggered.

**Deterrent:** If this option is turned on, the white light will be turned on for deterrence when an alarm is triggered.

**Event push:** If this option is set to ON, this type of information will be pushed to the client when an alarm is triggered.

**Schedule:** Used to set the scheduled time when an alarm acts. A series of alarm actions are triggered only within the scheduled time.

### 8.6.2.3 - Sound Alarm

EN

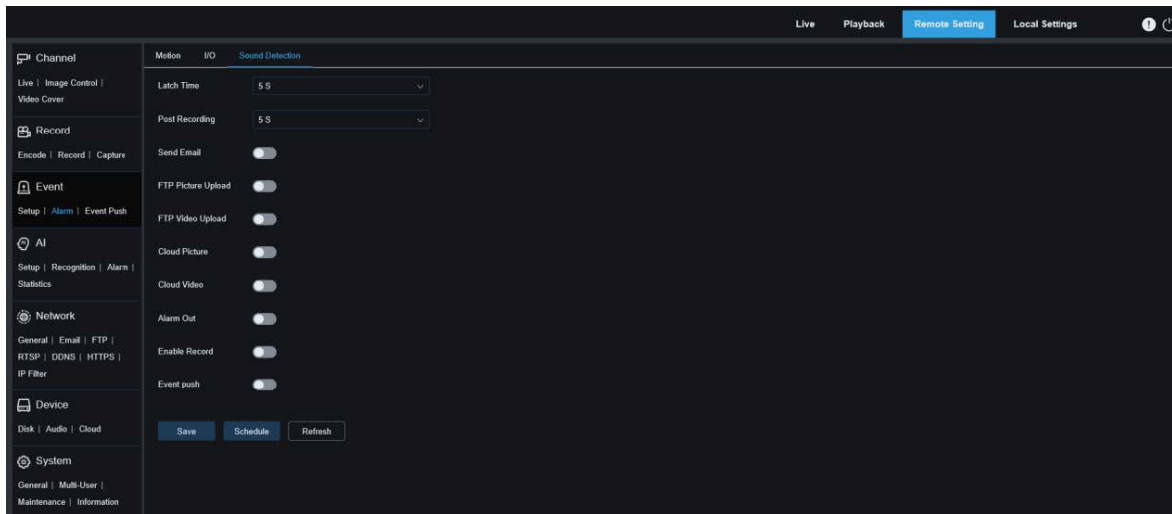

**Latch Time:** Used to set the duration for triggering an external alarm when a sound alarm is triggered.

**Post Recording:** You can set the duration of continuous recording after an event occurs. The options include 5s, 10s, 20s, and 30s. The default duration is 5s, but the maximum duration can be set to 30s.

**Send Email:** You can have the device automatically send you an email when it detects a sound alarm.

**FTP Picture Upload:** Used to upload alarm pictures to the FTP server.

**FTP Picture Video:** Used to upload alarm videos to the FTP server.

**Cloud Picture:** Used to upload alarm pictures to the cloud platform for storage.

**Cloud Video:** Used to upload alarm videos to the cloud platform for storage.

**Alarm Out:** Optional. If your device supports connection to an external alarm device, you can turn on this switch to activate the external alarm device.

**Enable Record:** If this option is turned on, this kind of recording will be enabled when an alarm is triggered.

**Schedule:** Used to set the scheduled time when an alarm acts. A series of alarm actions are triggered only within the scheduled time.

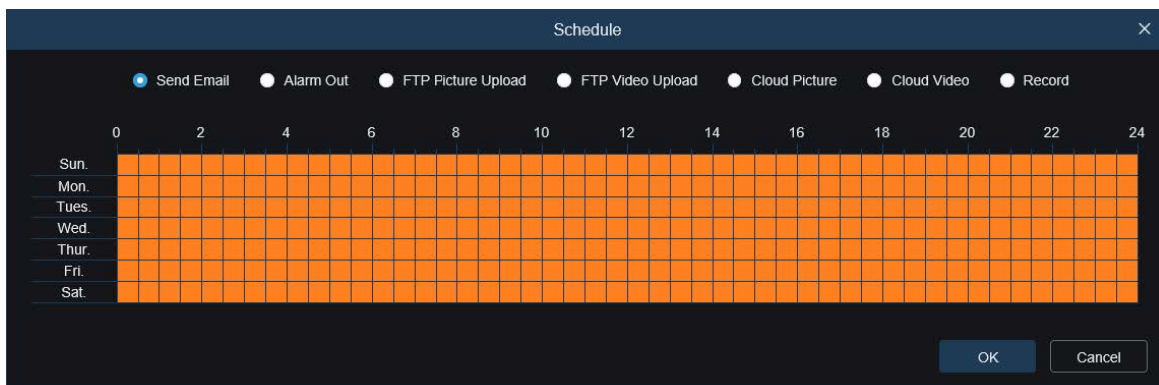

## 8.6.2.4 - Video Tampering Alarm

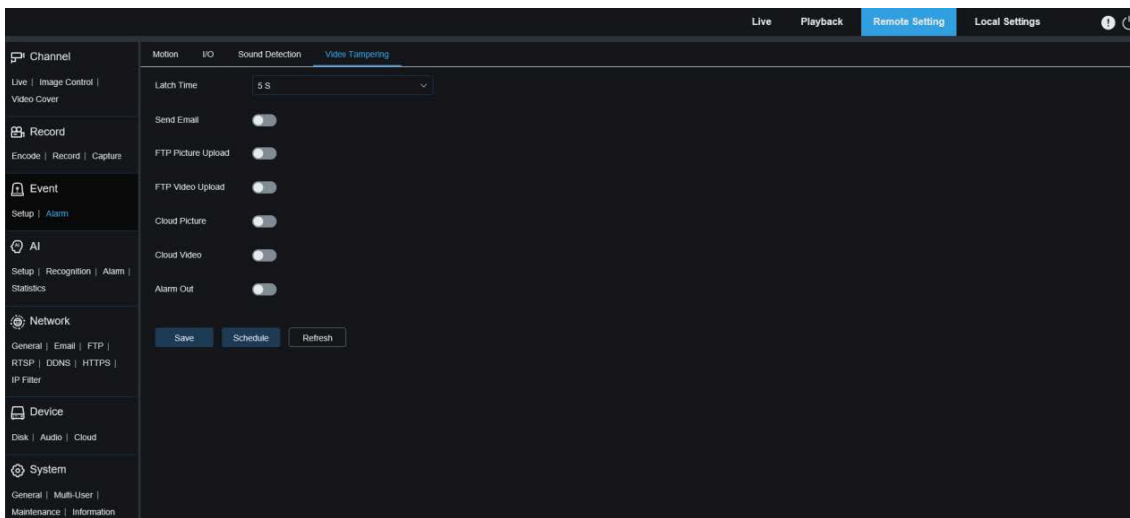

**Latch Time:** Used to set the duration for triggering an external alarm when a video tampering alarm is triggered.

**Send Email:** You can have the device automatically send you an email when it detects a sound alarm.

**FTP Picture Upload:** Used to upload alarm pictures to the FTP server.

**FTP Video Upload:** Used to upload alarm videos to the FTP server.

**Cloud Picture:** Used to upload alarm pictures to the cloud platform for storage.

**Cloud Video:** Used to upload alarm pictures to the cloud platform for storage.

**Alarm Out:** Optional. If your device supports connection to an external alarm device, you can turn on this switch to activate the external alarm device.

**Schedule:** Used to set the scheduled time when an alarm acts. A series of alarm actions are triggered only within the scheduled time.

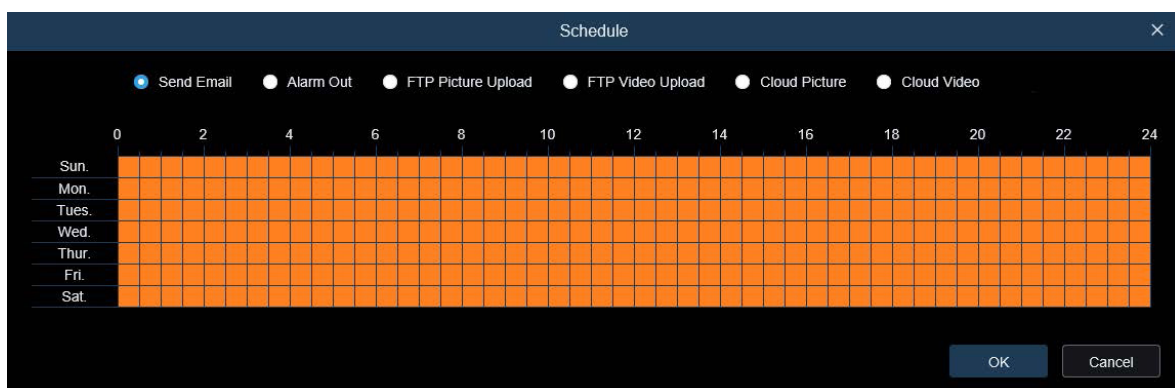

**NOTE:** Some models support the video tampering function.

## 8.6.3 - Event Push Function Settings

Event push can be implemented in two modes: HTTP push mode and UDP push mode. HTTP push mode provides POST method and GET method. UDP push mode provides unicast, multicast, and broadcast methods.

EN

**NOTE:** Only some models support the event push function.

### 8.6.3.1 - HTTP Push

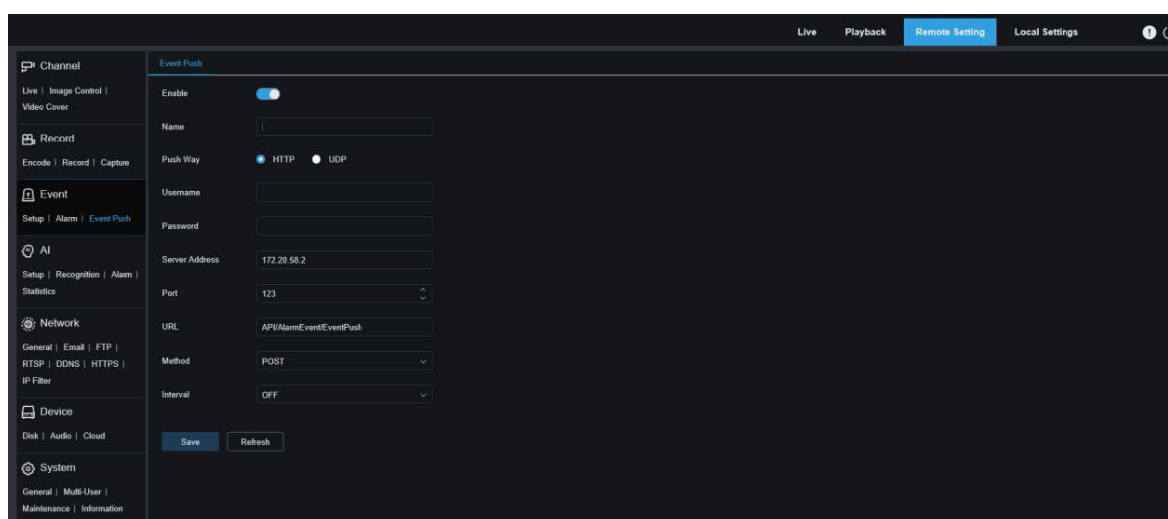

**Enable:** Used to enable or disable the event push function.

**Name:** Used to set the channel name.

**Push Way:** Used to set the push mode. Both HTTP push mode and UDP push mode are supported. You can select HTTP or UDP as required.

**Username:** Used to set the username. It can be set to NULL if there is not any.

**Password:** Used to set the password. It can be set to NULL if there is not any.

**Server Address:** Used to set the server address.

**Port:** Used to set the server port. (Port number range: 1 65535.)

**URL:** Used to set the server API. It can be set to NULL if there is not any.

**Method:** Used to set the HTTP push method. Both POST and GET methods are supported. Only the HTTP POST method supports image push. Other methods push notifications only. The alarm type of image push is the same as that in the alarm column of live view on the Web client.

**Interval:** Used to set the keep alive interval. The keep alive mechanism ensures that a notification is periodically pushed to the client in accordance with the preset time while normal alarm push is not affected. There is no keep alive mechanism in UDP mode.

### 8.6.3.2 - UDP Push

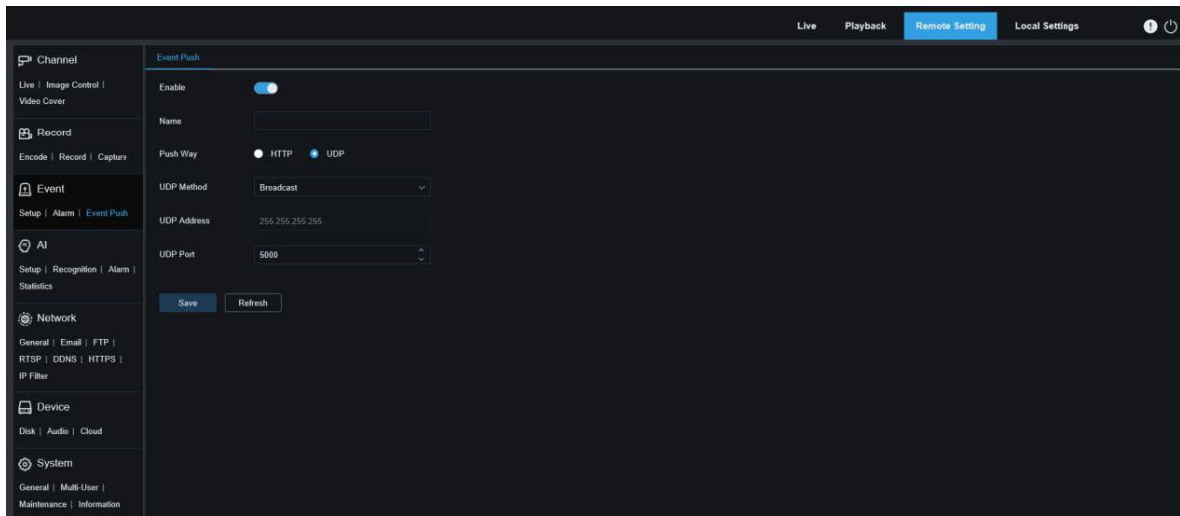

**Enable:** Used to enable or disable the event push function.

**Name:** Used to set the channel name.

**Push Way:** Used to set the push mode. Both HTTP push mode and UDP push mode are supported. You can select HTTP or UDP as required.

**UDP Method:** Used to set the UDP push method. There are three options: Unicast, Multicast, and Broadcast.

- **Unicast:** Enter the IP address and port number of the client UDP server for receiving push notifications. The notifications can be received by this address only.
- **Multicast:** Multiple clients in the same network segment of which the UDP servers use the same UDP address and port number can receive notifications. Other UDP addresses cannot receive notifications.
- **Broadcast:** All UDP servers in the same network segment can receive notifications.

**UDP Address:** Used to set the UDP server address.

**UDP Port:** Used to set the UDP server port. (Port number range: 1 65535)

## 8.7 - AI

### 8.7.1 - Setup

EN

To use the AI alarm function, enable the alarm function in the Setup menu. Enabling the function consumes the computing power of the camera.

Due to the limited performance of the camera, HM, RSD, and other functions can be enabled at the same time but not PID, LCD, SOD, FD, PD&VD, CC, CD, QD, and LPD.

## 8.7.1.1 - FD

Face detection function. First, the camera detects the face and obtain the capture image that meets the requirements. Then, the face feature data of the capture image is calculated by the face model algorithm and then compared with that in the face database. Finally an alarm is triggered. To do this, you need to enable the face detection function.

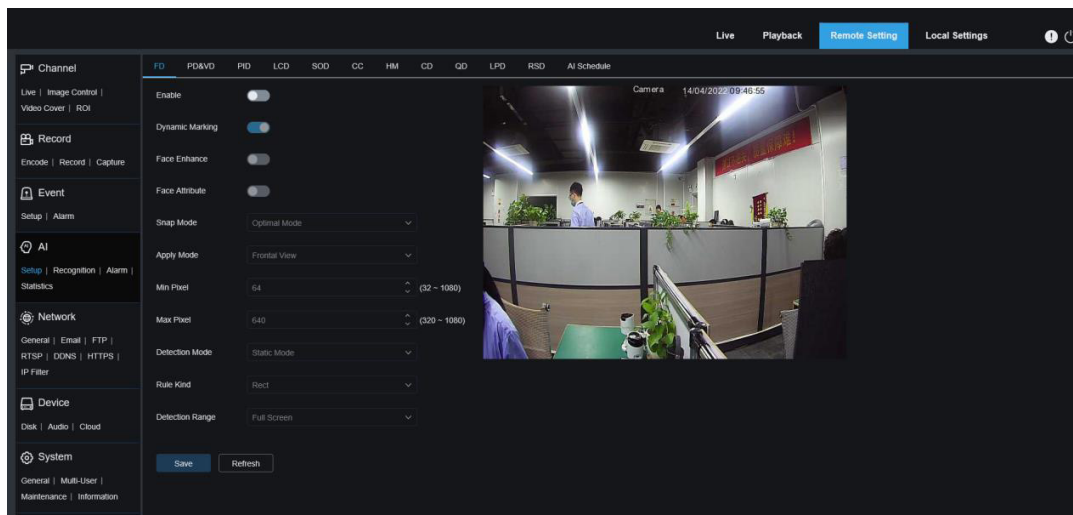

**Enable:** Used to enable the face detection function.

**Dynamic Marking:** Displays the face detection box and used to turn on or off the detection rule line.

**Face Enhance:** Face enhancement switch to increase the capture effect of moving objects. It will also adjust the brightness of the recognized face closest to the camera to optimize the capture effect.

**Face Attribute:** Used to recognize the features of the detected face image, including age, gender, mask, glasses, expression, and so on. Note: To use the AD alarm, enable this function.

**Snap Mode:** Used to set the snap mode. You can receive push notifications in live view or connect an NVR to check the image effect. The program supports three Snap Modes.

1. **Optimal Mode:** The camera only pushes an image that it considers best from detecting an object until the object disappears.
2. **RealTime Mode:** When detecting an object, the camera immediately pushes an image, and then pushes the best image when the object disappears.
3. **Interval Mode:** Used to set the snap number and the snap and push interval as required. The options for Snap Num include 1, 2, 3, and unlimited. The Snap Frequency ranges from 1s to 255s. For example, when the snap frequency is set to 5s, an image is pushed at 5s, 10s and 15s when the object is detected.

**Apply Mode:** Used to screen the captured images. That is, only the captured images that meet angle setting will be pushed. There are three mode options.

1. **Frontal View:** Only the frontal view of an object is pushed.



2. **Multi Angle:** You can choose to push images containing only side faces.
3. **Customize:** Used to customize the angle of an object for which images can be pushed. If this function is enabled, Roll Range, Pitch Range, Yaw Range, and Picture Quality options, as well as Frontal Default and Multi Default buttons will be available.

**Roll Range:** Used to set the roll range of the captured face image in the 3D model. When the angle does not meet the setting limit, face detection can be carried out but the image will not be pushed.

**Pitch Range:** Used to set the pitch range of the captured face image in the 3D model. When the angle does not meet the setting limit, face detection can be carried out but the image will not be pushed.

**Yaw Range:** Used to set the yaw angle of the captured face image in the 3D model. When the angle does not meet the setting limit, face detection can be carried out but the image will not be pushed.

**Picture Quality:** High quality images are good for filtering out detected non face images.

**Min Pixel:** Based on the 1080p resolution, filter out faces lower than the setting in the snap screen. The default resolution is 64x64 pixels, and the setting range is 32 to 1080 pixels.

**Max Pixel:** Based on the 1080p resolution, filter out faces greater than the setting in the snap screen. The default resolution is 640x640 pixels, and the setting range is 320 to 1080 pixels.

**Detection Mode:** Used to filter the performance of detected objects in the camera. There are two mode options.

1. **Static Mode:** Allows you do face detection for all objects in the view.
2. **Motion Mode:** Allows you to filter out motionless faces, such as such as portraits and statues in the scene.

**Rule Kind:** Used to set the detection rule line type. There are two rule types.

1. **Rect:** Allows you to detect only face objects in the set area.
2. **Line:** In this mode, face objects are tracked only when the detection line is crossed according to settings.

**Detection Range:** Setting options are changed when the detection area is used to recognize objects by default. There are two modes.

1. **Full Screen:** All areas that can be monitored by the camera are detected.
2. **Customize:** Only the areas selected in quadrilateral boxes are detected. The Rule Type setting option is available only when the line crossing detection mode is used. There are A→B and B→A detection Trigger Modes.

**Frontal Default Apply Mode:** This control is displayed when Customize is selected. Set the angles of the image to be pushed as follows: Range: 30, Pitch Range: 30, Yaw Range: 45, Picture Quality: 100

**Multi Default Apply Mode:** This control is displayed when Customize is selected. Set the angles of the image to be pushed as follows: Range: 180, Pitch Range: 180, Yaw Range: 180, Picture Quality: 100

**Rule Line Setting Area:** You can set the quadrilateral detection area or detection triggering line in this area according to parameter settings.

## 8.7.1.2 - PD&VD

Pedestrian detection and vehicle detection function, used to recognize pedestrian or vehicles in the view, generate an alarm, and record capture images, according function settings.

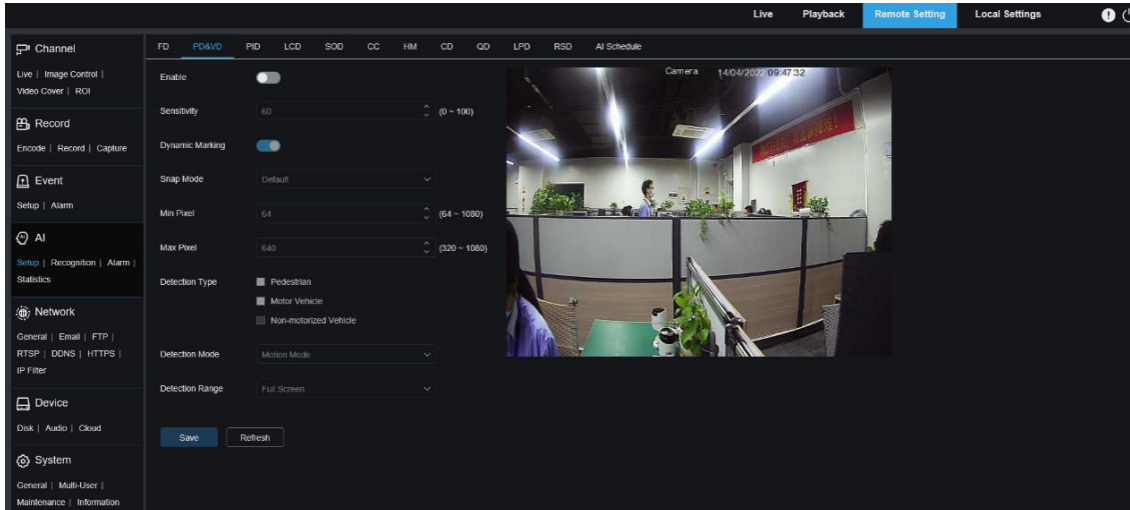

**Enable:** Used to enable the pedestrian and vehicle detection function.

**Sensitivity:** With higher detection sensitivity, pedestrian or vehicle objects can be detected easier, but false alarms may be easily generated.

**Dynamic Marking:** Displays the pedestrian and vehicle detection box and used to turn on or off the detection rule line.

**Snap Mode:** Used to set the snap mode. You can receive push notifications in live view or connect an NVR to check the image effect. The program supports three Snap Modes.

1. **Default:** The camera pushes only one pedestrian or vehicle image from detecting an object until the object disappears.
2. **RealTime Mode:** When detecting an object, the camera immediately pushes one image, and then pushes another image when the object disappears.
3. **Interval Mode:** Used to push images at a set interval.

**Snap Num:** Images for the same object as determined by the camera will be pushed 1, 2, 3, or unlimited times at an interval set in Snap Frequency.

**Snap Frequency:** Images will be pushed based on the set time upon appearance of an object or since the last push.

**Min Pixel:** Based on the 1080p resolution, filter out pedestrian or vehicle objects lower than the setting in the view.

**Max Pixel:** Based on the 1080p resolution, filter out pedestrian or vehicle objects greater than the setting in the view.

**Detection Type:** The options include pedestrian, motor vehicle, non motorized vehicle, and all.

**Detection Mode:** Used to filter object behaviours in the detection area. There are two mode options.

1. **Static Mode:** Allows you to detect all pedestrians or vehicles in the view.
2. **Motion Mode:** Allows you to filter out motionless pedestrians or vehicles.

**Detection Range:** Detection area setting. There are two mode options:

1. **Full Screen:** All areas that can be monitored by the camera are detected.
2. **Customize:** Only the areas selected in quadrilateral boxes are detected

**Rule Line Setting Area:** Allows you to configure detection settings in this area when the custom detection area mode is used.

### 8.7.1.3 - PID

Perimeter intrusion detection. An alarm is triggered when a specific object enters or leaves the warning area.

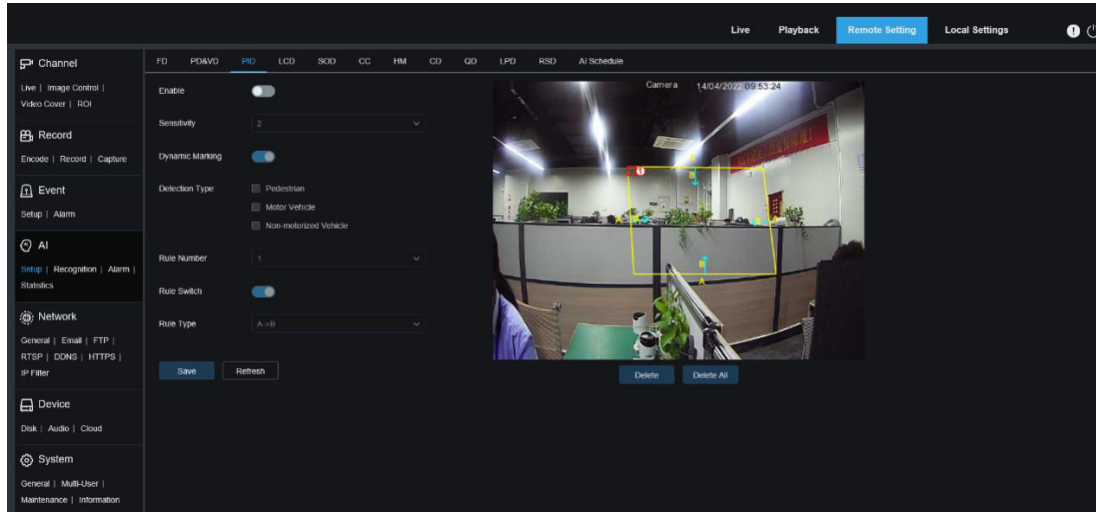

**Enable:** Used to turn on or off the perimeter intrusion alarm function.

**Sensitivity:** Used to filter small disturbing objects. The higher the sensitivity, the smaller the object can be detected.

**Dynamic Marking:** Displays the detection box and used to turn on or off the detection rule line

**Detection Type:** Used to set objects for perimeter intrusion detection:

- **Pedestrian:** An alarm is triggered when a pedestrian intrudes the perimeter.
- **Motor Vehicle:** An alarm is triggered when a motor vehicle intrudes the perimeter.
- **Non motorized Vehicle:** An alarm is triggered when a non motorized vehicle intrudes the perimeter.

**Rule Number:** Allows you to select a rule line number. The PID function allows you to set four detection rule lines.

**Rule Switch:** Used to turn on or off rule lines. Each rule line has an independent enable switch that is associated with the currently selected Rule Number.

**Rule Type:** Specifies the rule to trigger rule lines. There are A→B, B→A, and A↔B line crossing rules whose settings are related to the currently selected Rule Number.

**Rule Line Setting Area:** Allows you to set and view edited rule lines.

**Delete:** Allows you to delete selected rule Lines in the rule line setting area.

**Delete All:** Allows you to delete all rule lines.

## 8.7.1.4 - LCD

Line crossing detection function. An alarm is triggered when a specific object crosses the preset detection line.

EN

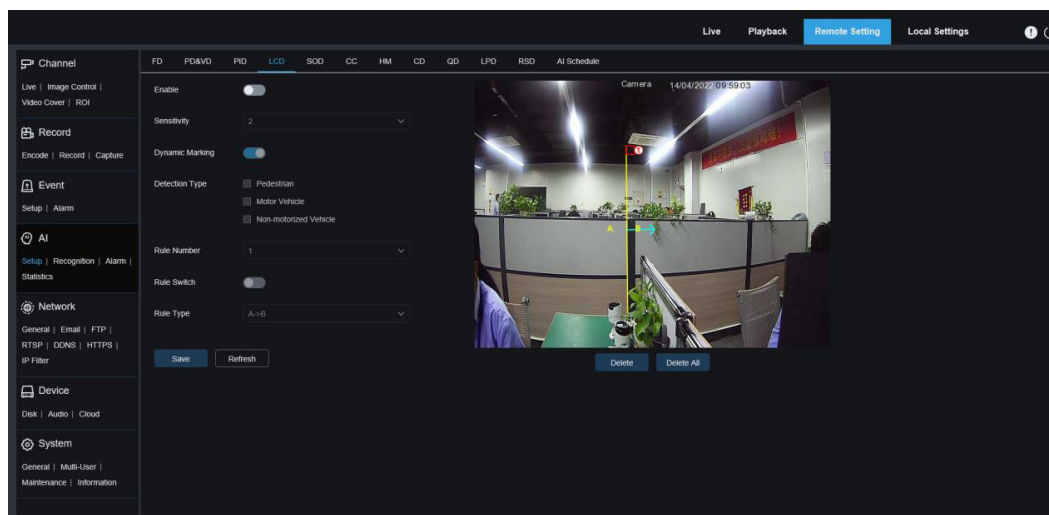

**Enable:** Used to enable the line crossing detection function.

**Sensitivity:** Used to filter small disturbing objects. The higher the sensitivity, the smaller the object can be detected.

**Dynamic Marking:** Displays the detection box and used to turn on or off the detection rule line.

**Detection Type:** Used to set objects for perimeter intrusion detection:

- **Pedestrian:** A perimeter intrusion alarm is triggered only for pedestrians.
- **Motor Vehicle:** A perimeter intrusion alarm is triggered only for motor vehicles.
- **Non motorized Vehicle:** A perimeter intrusion alarm is triggered only for non motorized vehicles.

**Rule Number:** Allows you to select a rule line number. The LCD function allows you to set four detection rule lines.

**Rule Switch:** Used to turn on or off rule lines. Each rule line has an independent enable switch that is associated with the currently selected Rule Number.

**Rule Type:** Specifies the rule to trigger rule lines. There are A→B, B→A, and A↔B line crossing rules whose settings are related to the currently selected Rule Number.

**Rule Line Setting Area:** Allows you to set, modify, and view edited rule lines.

**Delete:** Allows you to delete selected rule Lines in the rule line setting area.

**Delete All:** Allows you to delete all rule lines.

## 8.7.1.5 - SOD

Salient object detection. An alarm will be triggered when there are items left or lost in the monitored scene.

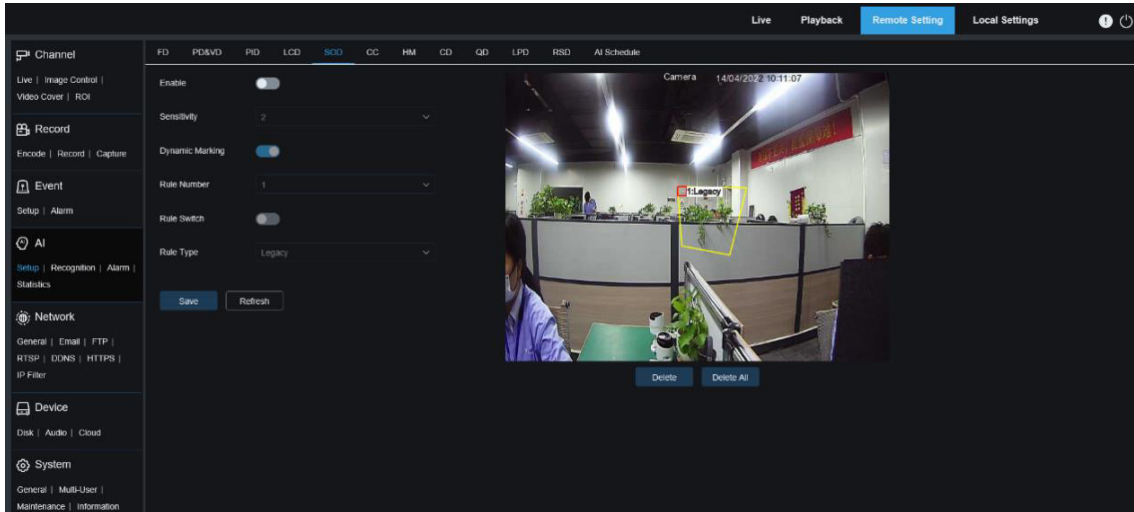

**Enable:** Used to turn on or off the SOD function.

**Sensitivity:** Used to filter small disturbing objects. The higher the sensitivity, the smaller the object can be detected.

**Dynamic Marking:** Displays the detection box and used to turn on or off the detection rule line.

**Rule Number:** Allows you to select a rule line number. The LCD function allows you to set four detection rule lines.

**Rule Switch:** Used to turn on or off rule lines. Each rule line has an independent enable switch that is associated with the currently selected Rule Number.

**Rule Type:** Specifies the rule to trigger rule lines. You can set to trigger an alarm when an item is left or lost in the detection area. There are three rules including Legacy, Lost, and Lost & Legacy whose settings are related to the currently selected Rule Number.

**Rule Line Setting Area:** Allows you to set, modify, and view edited rule lines.

**Delete:** Allows you to delete selected rule Lines in the rule line setting area.

**Delete All:** Allows you to delete all rule lines.

## 8.7.1.6 - CC

Cross counting (CC) statistics function. Used to record the line crossing information of a specific object in the monitored area. Set a crossing line. There are A and B areas on two sides of the set line. For example, the triggering rule for the rule line is A B. When an object enters from area A and crosses the detection line, in is increased by 1 when the object leaves area B. When the object enters from area B and crosses the detection line, out is increased by 1 when the object leaves area A. When the increase is to be calculated, an alarm is triggered only when the current IN count minus the out count is greater than or equal to the set Alarm Number, as shown in the following figure.

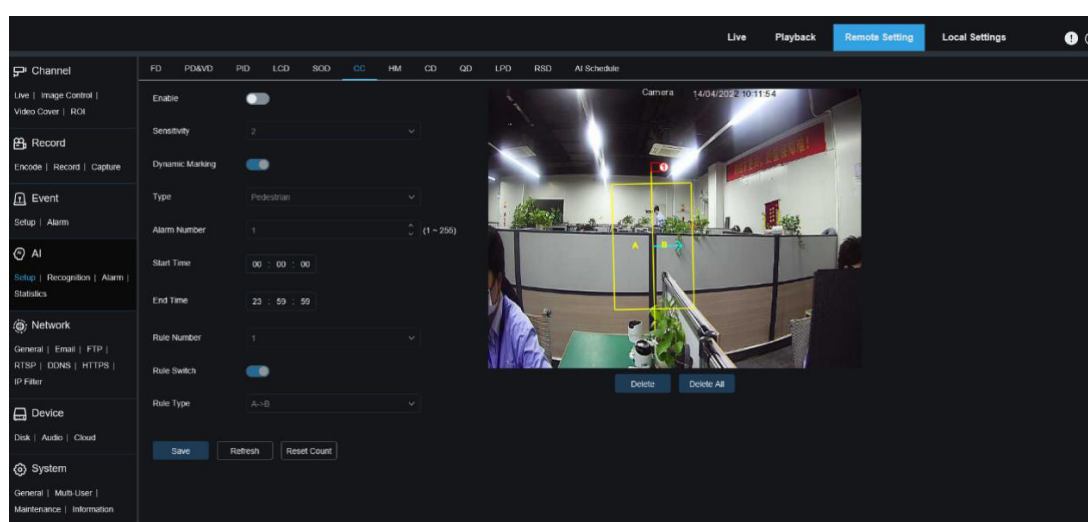

**Enable:** Used to enable the cross counting (CC) statistics function.

**Sensitivity:** Used to filter small disturbing objects. The higher the sensitivity, the smaller the object can be detected. This can also be used to detect distant objects in the scene.

**Dynamic Marking:** Displays the detection box and used to turn on or off the detection rule line.

**Type:** Used to set the type of objects to be recognized in the cross counting (CC) detection. There are three modes. Switchover or saving operation will clear the current count.

- **Motion:** All objects, including pedestrians, vehicles, and cartons, will be detected.
- **Pedestrian:** Only pedestrian objects will be recognized.
- **Motor Vehicle:** Only motor vehicle objects will be recognized.
- **Non motorized Vehicle:** Only non motorized vehicle objects will be recognized.

**Alarm Number:** Used to set conditions to trigger an alarm. The camera will trigger a CC alarm when the count is updated and the in count minus the out count is greater or equal to the current setting.

**Start Time:** The time when the line crossing detection function starts to work every day.

**End Time:** The time when the line crossing detection function stops working every day.

**Rule Number:** Rule line number. Only one detection rule line is supported for cross counting (CC)

**Rule Switch:** Used to turn on or off the current rule line.

**Rule Type:** Used to set the direction to increase the in/out trigger count, that is,  $A \rightarrow B$  and  $B \rightarrow A$ . For example, if  $A \rightarrow B$  is selected, the in count increases when the monitored object enters area A and leaves area B, and the out count increases when the monitored object enters area B and leaves area A.

**Reset Count:** Used to clear the currently displayed count.

**Line crossing Setting Area:** Allows you to set the rule line for cross counting (CC) detection in this area.

**Count Area:** Displays cross counting (CC) statistics. For details, refer to Adjusting Display Location in Section 8.1.



## 8.7.1.7 - HM

Heat map. You can set all areas or a specific area to detect the people activity information in the specified area. You can also save and upload changes at an interval of 10 minutes. The heat map can intuitively present people distribution in temporal and spatial dimensions for good understanding of activity degrees in each area in the scene. This function only supports data recording, not alarming.

EN

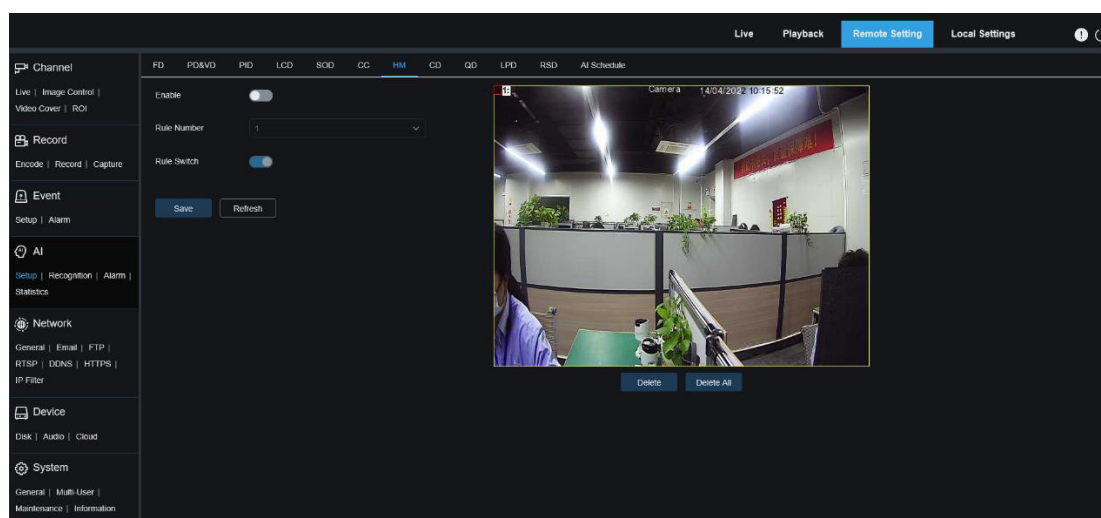

**Enable:** Used to turn on or off the HM statistics.

**Rule Number:** Rule line number. Only one detection rule line is supported for HM.

**Rule Switch:** Used to turn on or off the current rule line.

**Monitoring Area Setting:** Used to set the areas for collecting heat statistics. By default, all areas are selected.

Crowd detection function. Perform people counting and identify number of people in the monitored area. An alarm is triggered when the number of people exceeds the preset value.

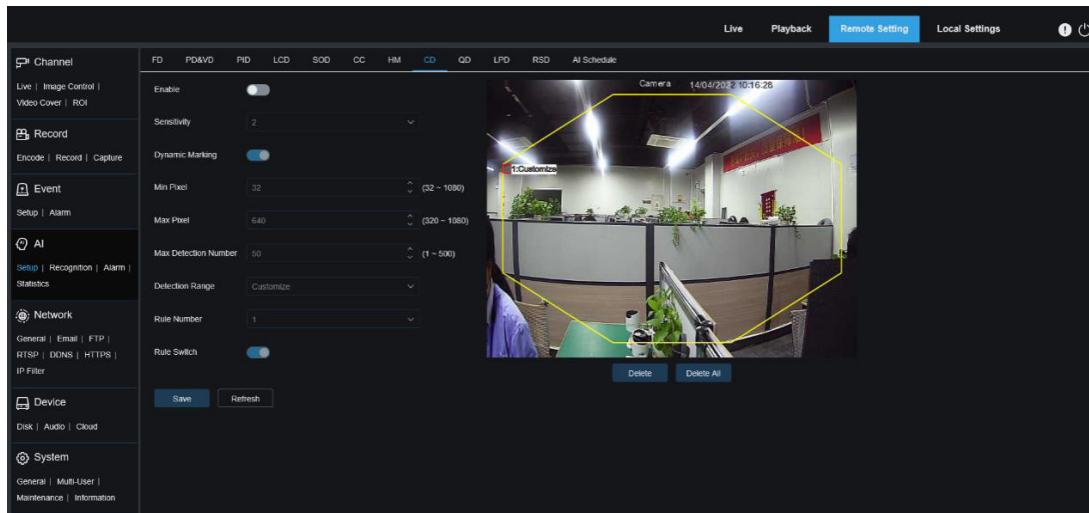

**Enable:** Used to turn on or off the crowd detection function.

**Sensitivity:** Used to filter small disturbing objects. The higher the sensitivity, the smaller the object can be detected.

**Dynamic Marking:** Displays the detection box and used to turn on or off the detection rule line.

**Min Pixel:** Based on the 1080p resolution, filter out objects with heads smaller than the setting in the view.

**Max Pixel:** Based on the 1080p resolution, filter out objects with heads larger than the setting in the view.

**Max Detection Number:** Maximum number of heads that can be detected in the detection area. An alarm will be triggered when this value is exceeded.

**Detection Range:** Used to set the area where the crowd detection function will be applied. There are two modes.

- **Full Screen:** In this mode, all areas covered by the camera will be detected.
- **Customize:** Allows you to customize detection areas.

**Rule Number:** Rule line number. This number is displayed when you set a custom detection area. One detection rule line is supported.

**Rule Switch:** Used to turn on or off the current rule line. This switch is displayed when you set a custom detection area.

**Detection Area Setting:** This setting is available when you set a custom detection area. An octagonal detection area needs to be set.

**Count Display Area:** Displays the number of people in the current monitored area. For adjustment of display location, see Section 8.1.

## 8.7.1.9 - QD

Queue detection function. Used to set the people number in the queue and wait time. An alarm will be triggered when the queue is too long or the wait time is too long.

EN

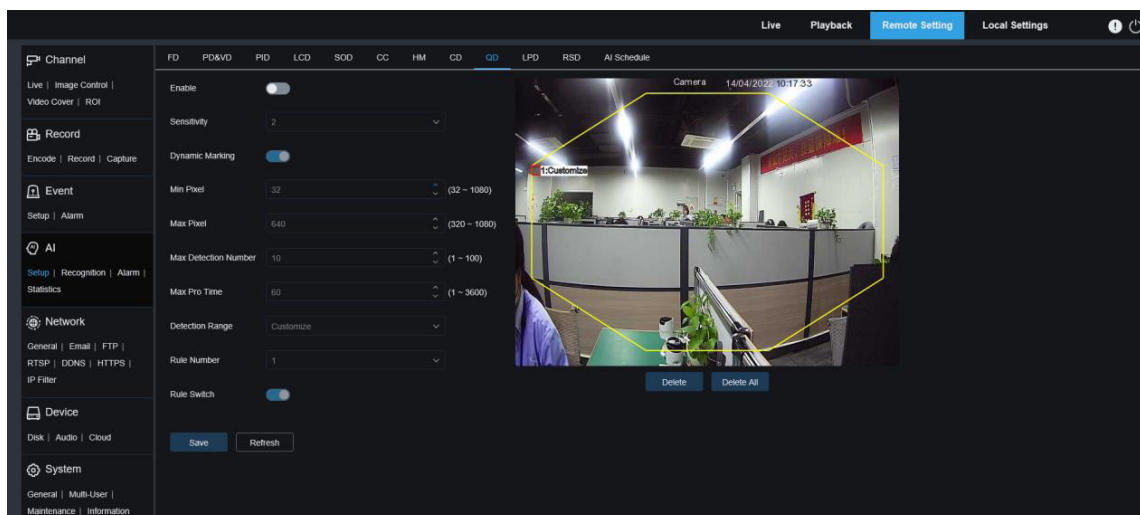

**Enable:** Used to turn on or off the queue detection function.

**Sensitivity:** Used to filter small disturbing objects. The higher the sensitivity, the smaller the object can be detected.

**Dynamic Marking:** Displays the detection box and used to turn on or off the detection rule line.

**Min Pixel:** Based on the 1080p resolution, filter out objects with heads smaller than the setting in the view.

**Max Pixel:** Based on the 1080p resolution, filter out objects with heads larger than the setting in the view.

**Max Detection Number:** Maximum number of heads that can be detected in the detection area. An alarm will be triggered when this value is exceeded.

**Max Pro Time:** The maximum duration allowed for people to stay in the detection area. An alarm will be triggered when the set duration is exceeded and no one leaves the detection area. (This duration starts from the time when the last person leaves the detection area. If no one leaves within the set duration, the processing will be considered as timeout and an alarm will be triggered.)

**NOTE:** Counting is restarted only when a target leaves the detection area. Counting will be ignored if the target in the area suddenly disappears. Counting is started only if a target is detected in the detection area.

**Detection Range:** Used to set the area where the queue detection function will be applied. There are two modes.

- **Full Screen:** In this mode, all areas covered by the camera will be detected.
- **Customize:** Allows you to customize detection areas.

**Rule Number:** Rule line number. This number is displayed when you set a custom detection area. One detection rule line is supported.

**Rule Switch:** Used to turn on or off the current rule line. This switch is displayed when you set a custom detection area.

**Detection Area Setting:** This setting is available when you set a custom detection area. An octagonal detection area needs to be set.

**Count Display Area:** Displays the number of people in the current monitored area and queue time. For adjustment of display location, see Section 8.1.

## 8.7.1.10 - LPD

License plate detection function. Used to detect license plates of passing vehicles to determine whether vehicles are registered to the database or not. An alarm will be triggered where necessary. Therefore, the license plate detection function needs to be enabled.

EN

**Currently, the license plate detection function is only available for European and American regions.**

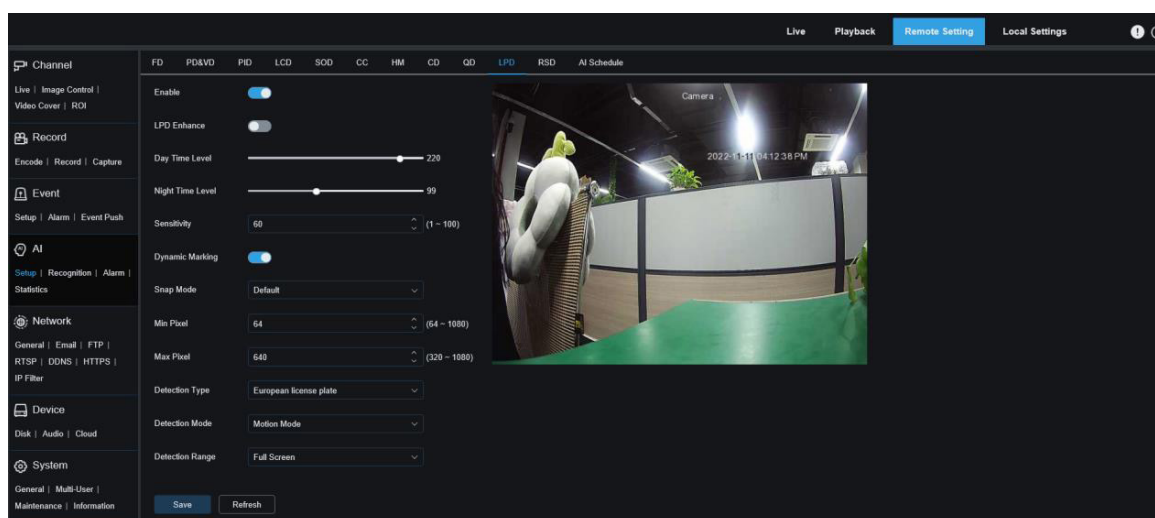

**Enable:** Used to turn on or off the license plate detection function.

**LPD Enhance:** Enable or disable the LPD Enhance function. This function and WDR, HLC, as well as BLC are mutually exclusive. Therefore, they cannot be enabled simultaneously. If the enhancement mode is enabled, the shutter mode and exposure time also cannot be adjusted.

**Day Time Level:** Day time level. When IR light is disabled for the camera, the higher the level, the brighter the image. Likewise, the lower the level, the dimmer the image. The level value ranges from 0 to 255.

**Night Time Level:** Night time level. When IR light is enabled for the camera, the higher the level, the brighter the image. Like wise, the lower the level, the dimmer the image. The level value ranges from 0 to 255.

**NOTE:** The level can be adjusted only when LPD and LPD Enhance are both enabled. When the LPD Enhance mode is enabled, the image brightness is adjusted based on the specified value for the day mode and night mode respectively. The two modes do not interfere with each other as they are switched automatically depending on whether the camera IR light is enabled. In addition, the LPD Enhance mode and the exposure compensation of image control, as well as the shutter manual mode are mutually exclusive. Therefore, they cannot be enabled simultaneously. If the LPD Enhance mode is enabled, the time exposure of image control also cannot be changed.

**Sensitivity:** Used to filter small disturbing objects. The higher the sensitivity, the easier it is to detect an object.

**Dynamic Marking:** Displays the detection box and used to turn on or off the detection rule line.

**Snap Mode:** Used to set the snap mode. You can receive push notifications in live view or connect an NVR to check the image effect. The program supports three Snap Modes.

- **Default:** The camera pushes only one license plate image from detecting an object until the object disappears.
- **RealTime Mode:** When detecting an object, the camera immediately pushes one image, and then pushes another image when the object disappears.
- **Interval Mode:** Used to push images at a set interval.

**Min pixel:** Minimum recognition pixel. Only license plates greater than the set minimum pixel can be recognized.

**Max pixel:** Maximum recognition pixel. Only license plates lower than the set maximum pixel can be recognized.

**Detection Type:** Type of license plates to be detected. There are two type options.

- **European license plate:** License plates in European regions.
- **American license plate:** License plates in American regions.

**Detection Mode:** License plate detection mode. There are two mode options.

- **Static Mode:** In this mode, static license plates in the view will be detected.
- **Motion Mode:** In this mode, motionless vehicles and their license plates will be filtered out and only license plates in motion will be detected.

**Detection Range:** Used to set the area where the license plate detection function will be applied. There are two type options.

**Full Screen:** Detection in full screen.

**Customize:** Allows you to customize detection areas.

## 8.7.1.11 - RSD

Sound exception detection. Here you can set different detection requirements depending on application requirements, for example, baby crying sound, gunshot, and dog barking. An alarm will be triggered when the camera detects the set sound.

EN

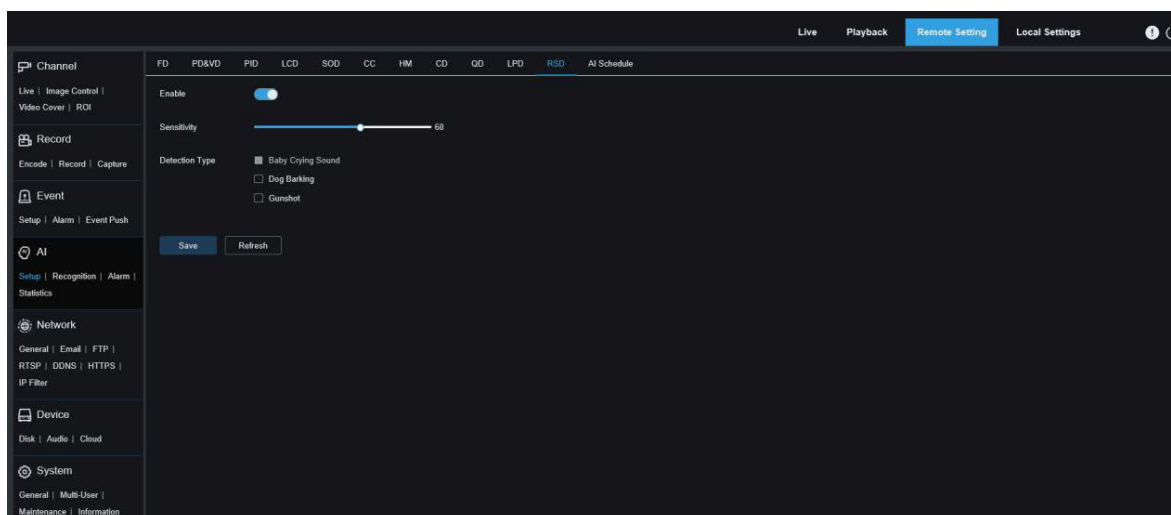

**Enable:** Used to turn on or off the sound exception detection function.

**Sensitivity:** Sensitivity. 1 indicates the minimum setting and 100 indicates the maximum setting.

**Detection Type:** Specifies detection type.

- **Baby Crying Sound:** A baby crying sound can be detected if this box is checked.
- **Dog Barking:** A dog barking sound can be detected if this box is checked.
- **Gunshot:** A gunshot sound can be detected if this box is checked.

## 8.7.1.12 - AI Schedule

AI schedule. You can set the AI enable schedule with this function. This function can be enabled or disabled.

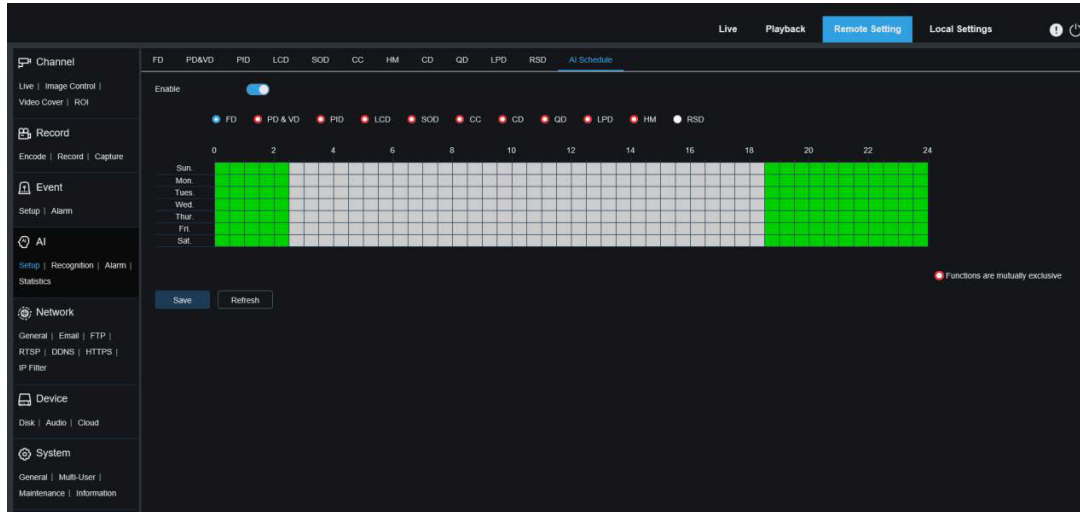

**Enable:** Used to turn on the schedule.

**Functions are mutually exclusive:** Functions that are mutually exclusive to the selected functions.

**i NOTE:**

1. Functions that are mutually exclusive cannot be set at the same time. That is, two mutually exclusive AI functions cannot be enabled at the same time. There will be restrictions on this UI.
2. After the AI schedule is enabled, all AI function switches for the channel can no longer be manually enabled or disabled and are controlled by the schedule. However, parameters such as sensitivity can be edited.



## 8.7.2 - Recognition

### 8.7.2.1 - Face Recognition

EN

Face recognition function. The focus is to recognize the identity of a detection object and use base data for comparison. The program establishes a database for face matching using the database management function.

**NOTE:** Changes to the database take full effect after the system reloads data for a short period of time.

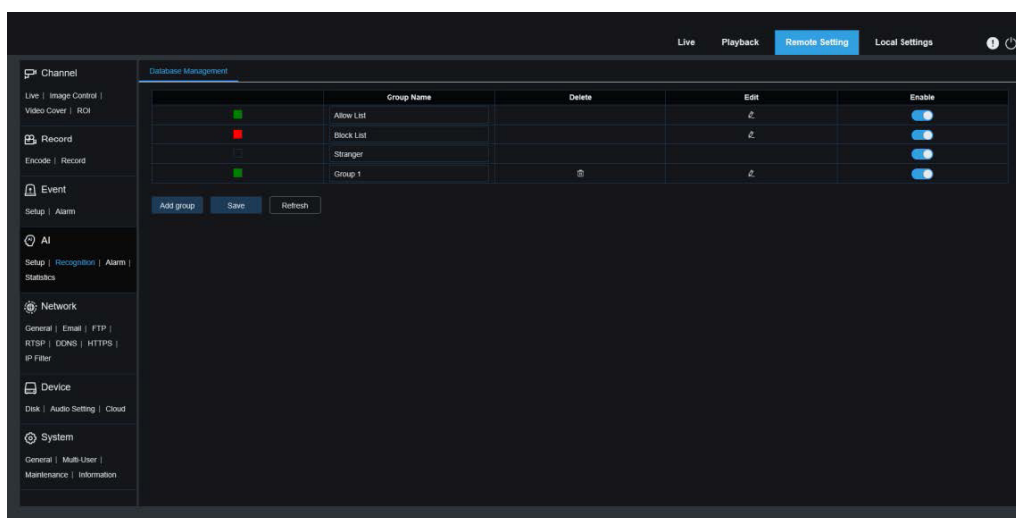

**Alarm Policy Display:** This serves as a policy prompt only in the camera. Green indicates the allow list, red indicates the block list, and colourless indicates the stranger group.

**Group Name:** Here you can edit, modify, and view the current group name. A group name will be pushed together with an alarm.

**Delete:** Here you can delete a group. The first three group cannot be deleted.

**Edit:** Here you can open the image setting example for this group. For details, please continue editing the content on the next image.

**Enable:** Used to turn on or off the face recognition function for data comparison between groups.

**Add Group:** Allows you to add a new database group. Up to 16 database groups can be added.

You can click the **Edit** icon to set the reference data for the corresponding group. The view is shown in the following figure.

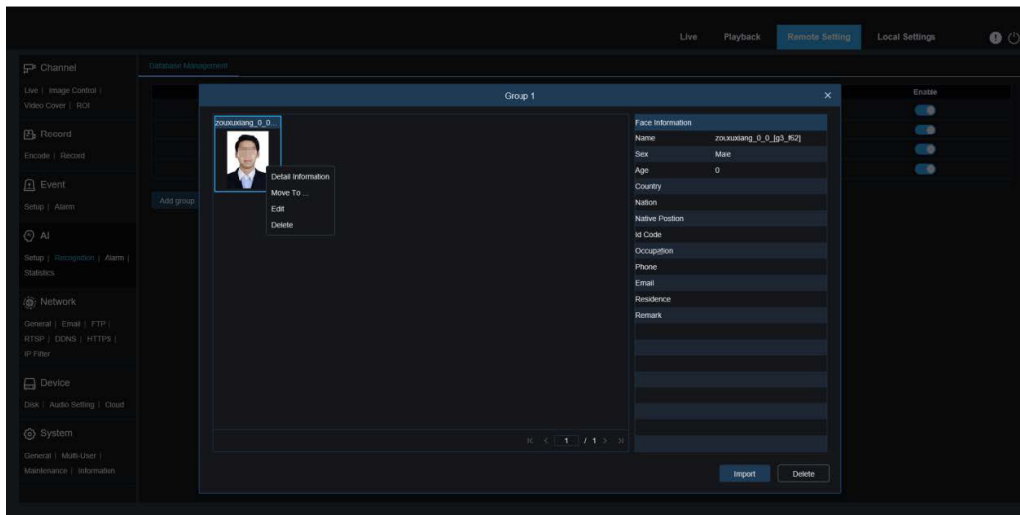

**Added Image Display Area:** Displays images that have been added to groups in the face database.

**Info:** Displays the editing information of the selected image.

**Detail Information:** Right click event to check the information of the selected image.

**Move To...:** Right click event to move the selected image to other groups.

**Edit:** Right click event to open the editing interface of the selected image to edit the information again.

**Delete:** Right click event to delete the selected image.

**Import:** You can add new face data in the current group and import local images or captured images by the camera.

**Delete:** Used to delete face data in batches in the database. You can click this icon, select the image to be deleted, and then click the Delete icon again to delete the image.

## 8.7.2.2 - License Plate Recognition

License plate recognition function. The focus is to recognize the identity of a detection object and use base data for comparison. The program establishes a database for license plate matching using the database management function.

EN

**NOTE:** Changes to the database take full effect after the system reloads data for a short period of time.

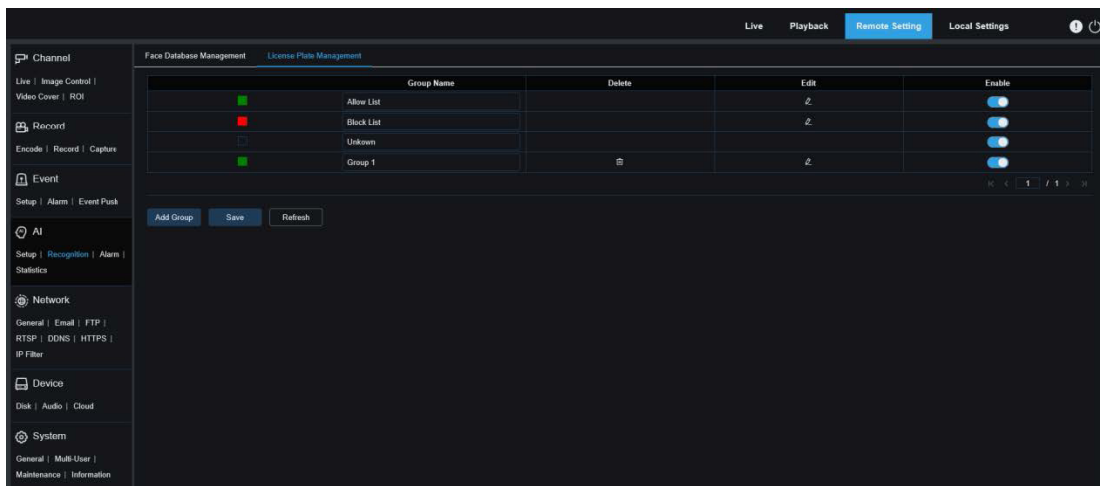

**Alarm Policy Display:** This serves as a policy prompt only in the camera. Green indicates the allow list, red indicates the block list, and colourless indicates the unknown license plate list.

**Group Name:** Here you can edit, modify, and view the current group name. A group name will be pushed together with an alarm.

**Delete:** Here you can delete a group. The first three group cannot be deleted.

**Edit:** Here you can open the image setting example for this group. For details, please continue editing the content on the next image.

You can click the **Edit** icon to set the reference data for the corresponding group. The view is shown in the figure below.

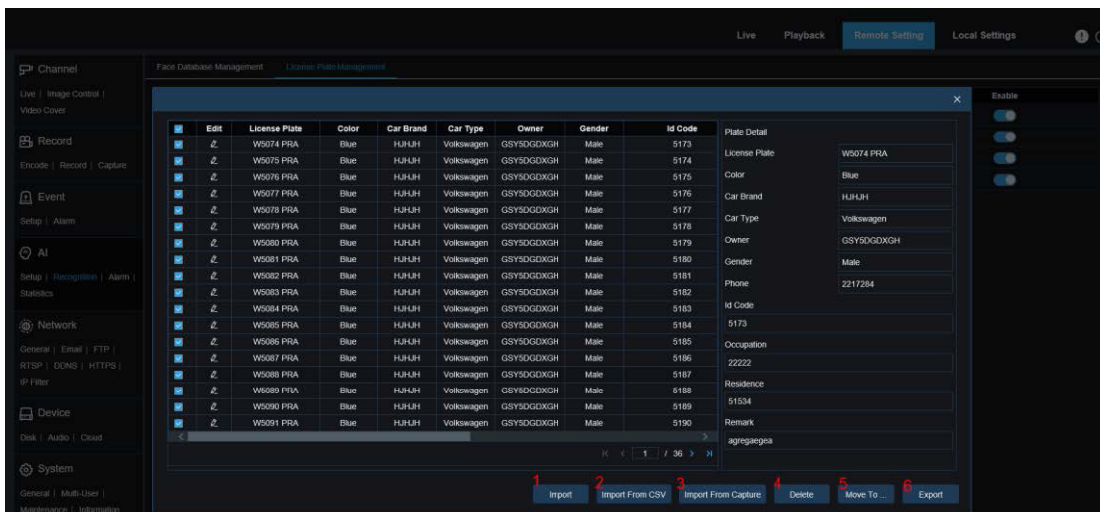

There are three ways to add license plate information: Import, Import From CSV, and Import from Local Capture.

1. You can click the **Import** button to manually add individual entries of license plate information.
2. You can click the **Import from CSV** button to import one or multiple data entries from CSV. The CSV sheet is formatted as follows:

A	B	C	D	E	F	G	H	I	J	K	L	M	N	O	P	Q	R	S	T	U	V	W	X	Y	Z
1	License Plate	Color	Car Brand	Car Type	Owner	Sex	Id Code	Phone	Occupati	Residence	Remark														
2	4C-3852	blue	H,R,H	Volkswagen	VHJ	male	2222	2212211	22222	46461	FFQFQFQ														
3	A-HP-233	white	H,R	NOMAL	UYUJ	male	101	11111	LLLL	KKLKLK	FOFOFOQ														
4	MCT1947	black	BBB	NOMAL	QQQQ	female	102	2145435	DAWQQR	FWEQW	QTFW														
5	FLP-260	black	R2R2AD	X205	QMGD	female	105	452525	GFPS	QJAGA	QTFWE														
6	MA 5465	White	TVAGA	SFSWF	FFFFFV	female	104	532535	FFFA	FAGA	FFVFA														
7	GC 9671	White	RCVYZCR	FEWTC	VIABZT	female	105	2.35E+09	NAVAGEC	AGHAG	AGEY														
8	LR66	BIE	white	GARJHDPJ	FTASDQ	ATYDF	ZDFV	male	106	3.47E+08	Ptata	agshrh	agresagea												
9	R21	ROY	white	BHH	TAT54	ARETAT	male	107	GIVTEP	HRJFFEDH	STUBO	PTAORH													
10	DE14	LVP	white	ETURHS	AYAGC	AERTVDF	male	108	45634	VEGABGA	AFSSS	KUKTT													
11	1218	LOJ	white	HBRHTST	VEYD	GYSDDG	male	109	4673	2875	SDG	SBRHT	TRKTHFX												
12	W12	FRA	yellow	QEGAGC	AGBAGC	GSYDGT	female	110	454393	FGSBA	CSG	WGA													
13	W13	FRA	blue	H,R,H	FEWTC	GYSDDG	male	112	2212223	22222	46473	FFQFQFQ													
14	W14	FRA	blue	H,R,H	FEWTC	GYSDDG	male	113	2212224	22222	46474	FFQFQFQ													
15	W15	FRA	blue	H,R,H	FEWTC	GYSDDG	male	114	2212225	22222	46475	QTFW													
16	W16	FRA	blue	H,R,H	FEWTC	GYSDDG	male	115	2212226	22222	46476	QTFWE													
17	W17	FRA	blue	H,R,H	FEWTC	GYSDDG	male	116	2212227	22222	46477	FFVFA													
18	W18	FRA	blue	H,R,H	FEWTC	GYSDDG	male	117	2212228	22222	46478	AGEY													
19	W19	FRA	blue	H,R,H	FEWTC	GYSDDG	male	118	2212229	22222	46479	agresagea													
20	W20	FRA	blue	H,R,H	FEWTC	GYSDDG	male	119	2212230	22222	46480	ETORH													
21	W21	FRA	blue	H,R,H	FEWTC	GYSDDG	male	120	2212231	22222	46481	KUKTT													
22	W22	FRA	blue	H,R,H	FEWTC	GYSDDG	male	121	2212232	22222	46482	TRKTHFX													
23	W23	FRA	blue	H,R,H	FEWTC	GYSDDG	male	122	2212233	22222	46483	WGA													
24	W24	FRA	blue	H,R,H	FEWTC	GYSDDG	male	123	2212234	22222	46484	FFQFQFQ													
25	W25	FRA	blue	H,R,H	FEWTC	GYSDDG	male	124	2212235	22222	46485	FFQFQFQ													
26	W26	FRA	blue	H,R,H	FEWTC	GYSDDG	male	125	2212236	22222	46486	QTFW													
27	W27	FRA	blue	H,R,H	FEWTC	GYSDDG	male	126	2212237	22222	46487	QTFWE													
28	W28	FRA	blue	H,R,H	FEWTC	GYSDDG	male	127	2212238	22222	46488	FFVFA													
29	W29	FRA	blue	H,R,H	FEWTC	GYSDDG	male	128	2212239	22222	46489	AGEY													
30	W30	FRA	blue	H,R,H	FEWTC	GYSDDG	male	129	2212240	22222	46490	agresagea													
31	W31	FRA	blue	H,R,H	FEWTC	GYSDDG	male	130	2212241	22222	46491	ETORH													
32	W32	FRA	blue	H,R,H	FEWTC	GYSDDG	male	131	2212242	22222	46492	KUKTT													
33	W33	FRA	blue	H,R,H	FEWTC	GYSDDG	male	132	2212243	22222	46493	TRKTHFX													
34	W34	FRA	blue	H,R,H	FEWTC	GYSDDG	male	133	2212244	22222	46494	WGA													
35	W35	FRA	blue	H,R,H	FEWTC	GYSDDG	male	134	2212245	22222	46495	FFQFQFQ													
36	W36	FRA	blue	H,R,H	FEWTC	GYSDDG	male	135	2212246	22222	46496	FFQFQFQ													
37	W37	FRA	blue	H,R,H	FEWTC	GYSDDG	male	136	2212247	22222	46497	QTFW													
38	W38	FRA	blue	H,R,H	FEWTC	GYSDDG	male	137	2212248	22222	46498	QTFWE													
39	W39	FRA	blue	H,R,H	FEWTC	GYSDDG	male	138	2212249	22222	46499	FFVFA													
40	W40	FRA	blue	H,R,H	FEWTC	GYSDDG	male	139	2212250	22222	46500	AGEY													
41	W41	FRA	blue	H,R,H	FEWTC	GYSDDG	male	140	2212251	22222	46501	agresagea													
42	W42	FRA	blue	H,R,H	FEWTC	GYSDDG	male	141	2212252	22222	46502	agresagea													

Select the license plate file in CSV format you want to import and click the Import button to add it to the group. You can click the Delete button to delete unwanted license plate information, as shown in the figure below.

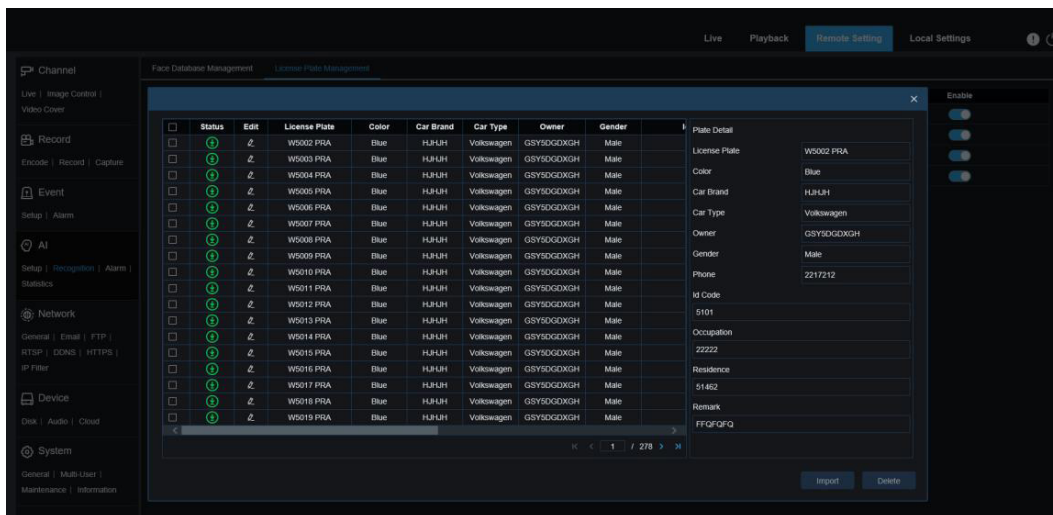

**NOTE:** When more than 5000 data entries will be added, a dialogue box indicating "Data entries exceed the upper limit" will appear.

3. You can click the Import from Capture button to import license plate information from a local directory to the database.

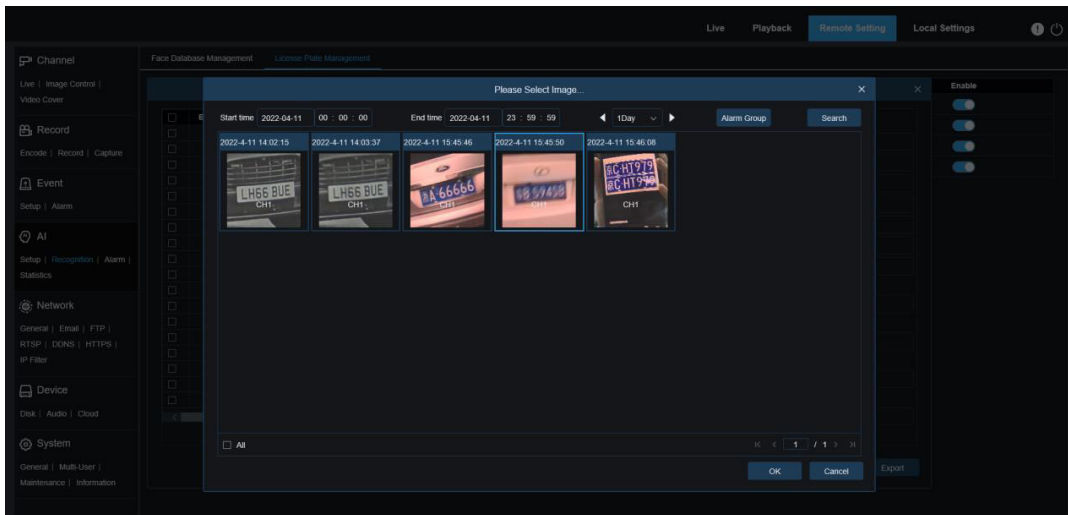

EN

You can select the date, duration, and Alarm Group, and then click the Search button to retrieve all the license plates saved by the device within this time range.

**All:** Used to select all license plate information.

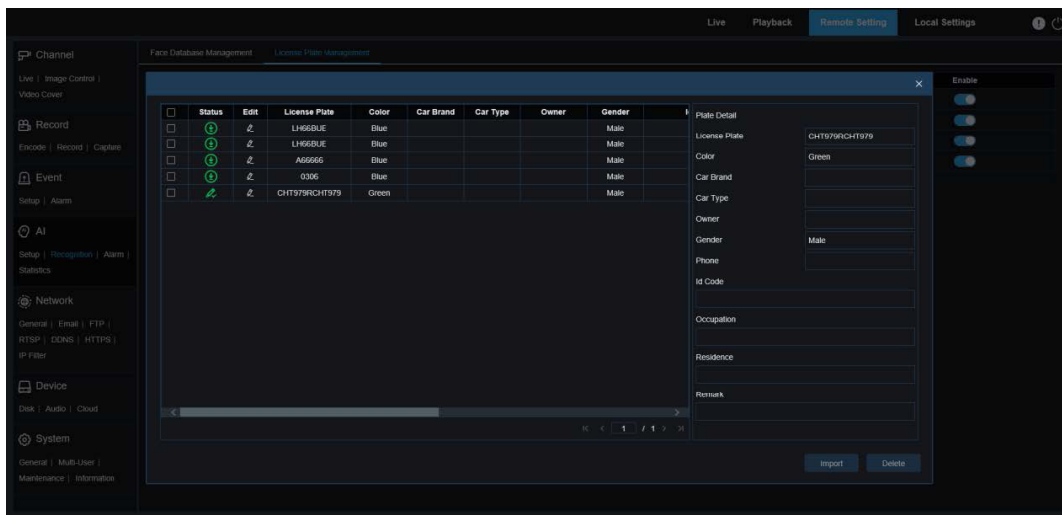

You can click a data entry to edit the corresponding license plate information. Then, you can click the **Save** button to save changes. Upon completion of change, will change to .

4. **Delete:** You can check the checkbox next to the license plate information and then click this button to delete the information.
  5. **Move to...:** You can check the checkbox next to the license plate information and then click this button to move the information to other groups.
  6. You can click the **Export** button to export the information of the entire group and then save it.
1. **Enable:** Used to turn on or off the license plate recognition function for data comparison between groups.
  2. **Add Group:** Allows you to add a new database group. Up to 16 database groups can be added.

## 8.7.3 - Alarm Setup

Alarm response to AI functions of the camera can be divided into three categories in the implementation dimension:

**Category I** includes FD, AD, PD&VD, PID, LCD, SOD, CC, CD, QD, LPD, and RSD. Alarm response will be generated directly if alarm conditions are met as determined by the camera.

**Category II** includes FR and LPR. The camera captures an alarm image and recognizes the face feature value or license plate information in the image, then compares it with the information in the database, and finally generates an alarm response according to the alarm group setting.

**Category III** includes FA. Automatically search data at a specific time to generate alarm push email.

### 8.7.3.1 - FD, AD, PD&VD, PID, LCD, SOD, CC, CD, QD, LPD, RSD

Alarm response will be generated directly if alarm conditions are met as determined by the camera.

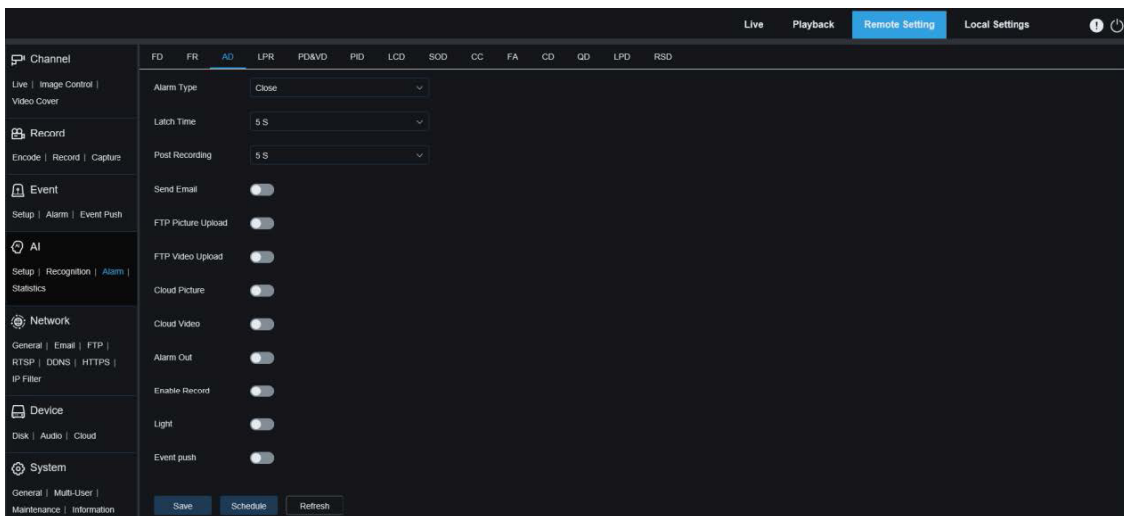

**Alarm Type:** This option is specific to AD alarms. Enable the face attribute recognition function for AD alarms according to Section 8.7.1.1. An alarm will be generated to alert whether the detected object wears a mask. There are three mode options.

- **Close:** AD alarms are disabled.
- **NO Mask:** An alarm is generated when the detected object is not wearing a mask.
- **Wear Mask:** An alarm is generated when the detected object is wearing a mask.

**Latch Time:** Specifies the duration of an I/O alarm after the alarm is cleared.

**NOTE:** The camera must support the I/O feature and the working time is controlled by the schedule.

**Post Recording:** Specifies the duration of recording after the alarm is cleared.

**NOTE:** The effective time is also controlled by the schedule.

**Send Email:** Specifies whether to send an email when an alarm is being triggered.

**NOTE:** The effective time is also controlled by the schedule.

**FTP Picture Upload:** Specifies whether to send pictures to the associated FTP server when an alarm is being triggered. If the alarm is continuously triggered, the pictures will be sent at an interval of 10s until the alarm is cleared.

**NOTE:** The effective time is also controlled by the schedule and the FTP server shall be associated in advance.

**FTP Video Upload:** Specifies whether to send videos to the associated FTP server when an alarm is being triggered. If the alarm is continuously triggered, the videos will be sent at an interval of 10s until the alarm is cleared.

**NOTE:** The effective time is also controlled by the schedule and the FTP server shall be associated in advance.

**Cloud Picture:** Specifies whether to send pictures to the associated cloud storage server when an alarm is being triggered. If the alarm is continuously triggered, the pictures will be sent at an interval of 10s until the alarm is cleared.

**NOTE:** The effective time is also controlled by the schedule and the cloud storage server shall be associated in advance.

**Cloud Video:** Specifies whether to send videos to the associated cloud storage server when an alarm is being triggered. If the alarm is continuously triggered, the videos will be sent at an interval of 10s until the alarm is cleared.

**NOTE:** The effective time is also controlled by the schedule and the cloud storage server shall be associated in advance.

**Alarm Out:** Specifies whether to enable Latch Time.

**Enable Record:** Specifies whether to enable Post Recording.

**Schedule:** Used to configure the schedule of Send Email, Alarm Out, FTP Picture Upload, FTP Video Upload, Cloud Picture, Cloud Video, Record, Light (Deterrent), and Siren (Deterrent) for the current alarm.

**NOTE:** The white light deterrence feature is available for some models.

**Deterrent:** White light deterrence switch. When an alarm is triggered, an alarm response is generated according to the setting on the Remote Setting Event Setup Deterrence page. Deterrence includes white light and siren which are controlled by the schedule.

**NOTE:** The white light deterrence feature is available for some models.

**Warn Light:** Warning light deterrence switch. When an alarm is triggered, the alarm is reported in accordance with the warning light configuration on the **Deterrence** screen (GUI path: Remote Setting → Event → Setup → Deterrence ).

 **NOTE:** Only some models support warning light.

**Siren:** Siren deterrence switch. When an alarm is triggered, the alarm is reported in accordance with the siren configuration on the **Siren** screen (GUI path: Remote Setting → Event → Setup → Siren ).

 **NOTE:** Only some models support siren deterrence.

**Event push:** If this option is set to ON, this type of information will be pushed to the client when an alarm is triggered.



### 8.7.3.2 - FR

EN

Face recognition. The camera captures a face image and retrieve matching face data from the database to obtain the group the object is in. Then, the camera generates an alarm by calling out the alarm setting in this group. Changes to parameters take effect after the system reloads data for a short period of time.

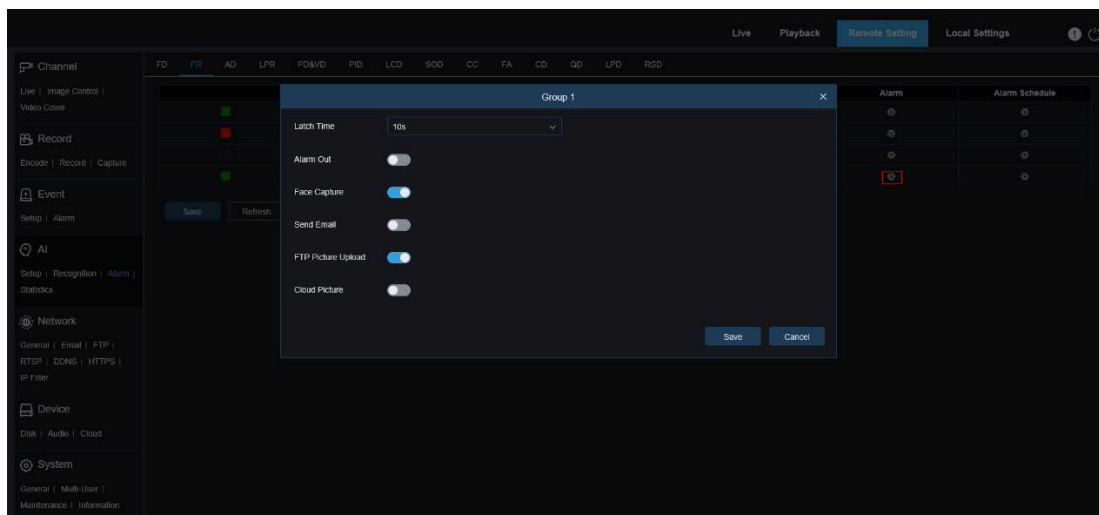

**Group Name:** Here you can edit, modify, and view the current group name. A group name will be pushed together with an alarm in the live view.

**Enable:** Specifies whether to enable alarm response settings.

**Policy:** Alarm policy. The first three groups cannot be edited and other groups can be customized as Allow or Deny.

**Similarity:** An alarm is triggered when the similarity exceeds the threshold during face matching.

**Alarm:** Specifies whether to enable group alarm settings.

**Alarm Schedule:** Specifies the effective time of the Send Email, Alarm Out, FTP Picture Upload, and Cloud Picture settings.

**Latch Time:** Specifies the duration of an I/O alarm after the camera captures the image and successfully retrieves the matched image in the database.

**NOTE:** The camera must support the I/O feature and the working time is controlled by the schedule.

**Alarm Out Latch Time:** Specifies whether to enable settings.

**Save Picture:** Specifies whether to save face images to the memory card. This setting is not controlled by the Enable status.

**Save the Background:** Specifies whether to save face images to the memory card and at the same time save background images. This setting is not controlled by the Enable status.

**Send Email:** Specifies whether to send an email when faces in the group are recognized and matched.

**NOTE:** The effective time is also controlled by the schedule.

**FTP Picture Upload:** Specifies whether to send pictures to the associated FTP server when faces in the group are recognized and matched.

**i NOTE:** The effective time is also controlled by the schedule and the FTP server shall be associated in advance.

**Cloud Picture:** Specifies whether to send pictures to the associated cloud storage server when faces in the group are recognized and matched.

**i NOTE:** The effective time is also controlled by the schedule and the cloud storage server shall be associated in advance.

### 8.7.3.3 - FA

EN

The face attendance (FA) function is used to retrieve face matching status in different groups (excluding stranger group) saved in the memory card in a specified period of time, and generate attendance files according to capture records, and send these files to the associated email address.

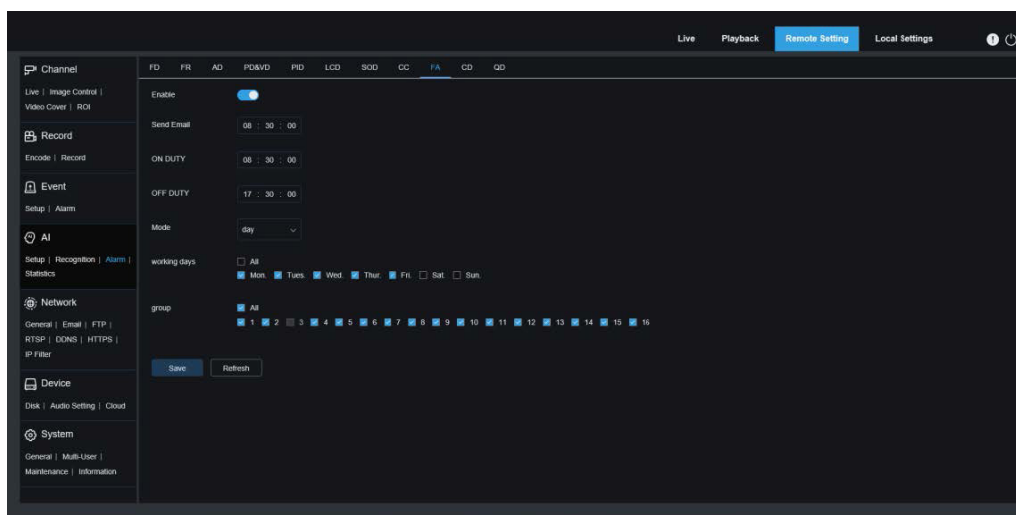

**Enable:** Used to turn on or off the automatic face attendance file generation function.

**Send Email:** Specifies the time to send face attendance status. The program will make retrieval at a certain interval. When the retrieval time is greater than the set time, an attendance record file is automatically generated and an email is sent.

**NOTE:** No email will be sent if no attendance record is available.

**ON DUTY:** Specifies the on duty reference time to generate an attendance file.

**OFF DUTY:** Specifies the off duty reference time to generate an attendance file.

**Mode:** Specifies the time to generate and send an attendance file. There are three mode options.

- **Day:** Allows you to send the attendance record file of the day before.
- **Week:** For example, if it is set to Wednesday, the attendance information from last Wednesday to this Tuesday will be sent on Wednesday.
- **Month:** For example, if it is set to the 15th day, the attendance information from the 15th day of the last month to the 14th day of this month will be sent on the 15th day of each month.

**Working days:** Specifies the on duty reference working days to generate an attendance file.

**Group:** Specifies the group subject to attendance check when an attendance file is generated.

**NOTE:** This function is unavailable for the stranger group and greyed out for group 3 by default.

## 8.7.4 - Statistics

AI enabled statistical analysis function.

### 8.7.4.1 - Face Detection

Face image statistical analysis function. This function allows you to retrieve face data statistics stored in the memory card according to search settings. The screen is shown in the figure below.

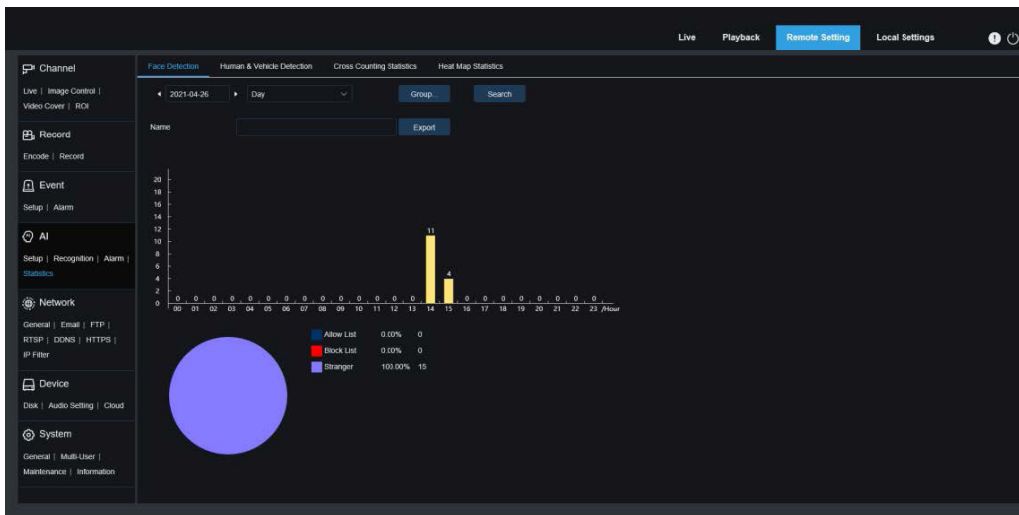

**Time:** Specifies the reference time for the Search Mode.

**Search Mode:** You can specify Day, Week, Month, Quarter, and Year as time range for data retrieval.

**Group:** Specifies the group subject to retrieval when statistical data is being retrieved.

**Search:** Allows you to re initiate data retrieval according to the current search settings.

**Export:** You need to give a name to an exported file. Export current search results to an Excel file.

**Display Area:** Displays search results in a graph below.

## 8.7.4.2 - Human & Vehicle Detection

Human and vehicle statistics, including PD&VD, PID, and LCD alarms. The screen is shown in the figure below.

EN

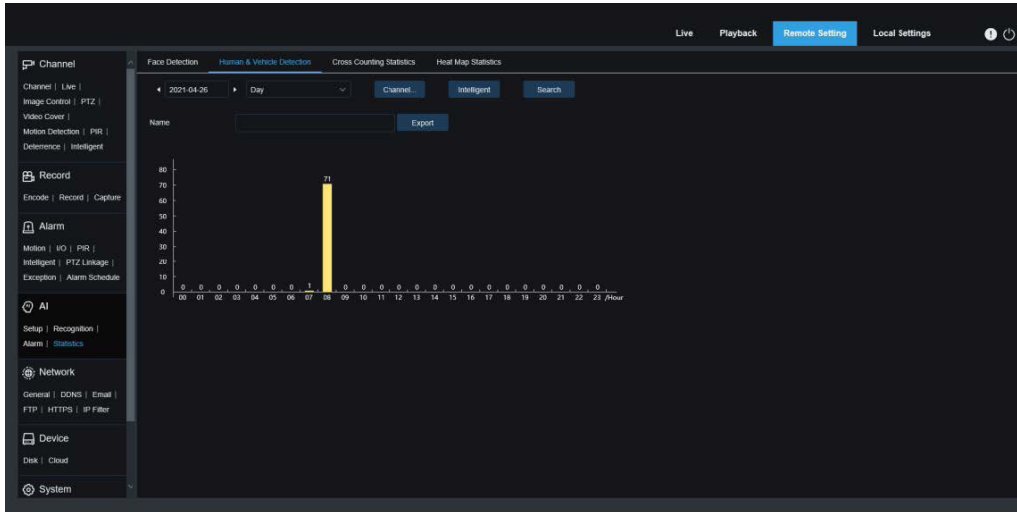

**Time:** Specifies the reference time for the Search Mode.

**Search Mode:** You can specify Day, Week, Month, Quarter, and Year as time range for data retrieval.

**Intelligent:** Allows you to perform search according to tag type of captured images, including PID (Human), PID (Vehicle), LCD (Human), LCD (Vehicle), Human, and Vehicle.

**Search:** Allows you to re initiate data retrieval according to the current search settings.

**Export:** You need to give a name to an exported file. Export current search results to an Excel file.

**Display Area:** Displays search results in a graph.

### 8.7.4.3 - Cross Counting Statistics

Cross counting (CC) statistics. The screen is shown in the figure below.

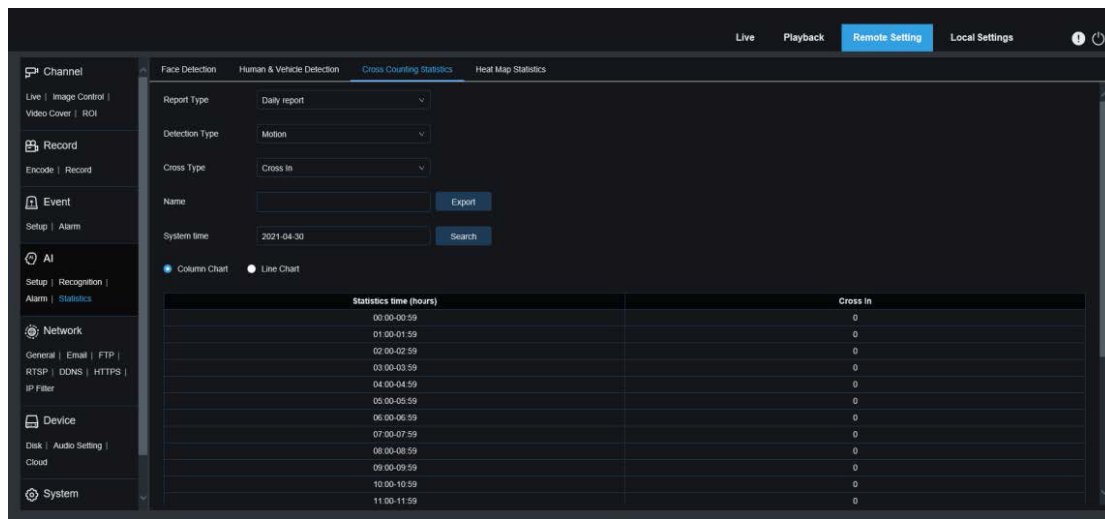

**Report Type:** The options include Daily report, Weekly report, Monthly report, and Annual report.

**Detection Type:** Used to set your desired alarm model. For example, you cannot retrieve motion triggered data if alarm models other than motion model are selected. There are three model options including Motion, Person, and Vehicle, corresponding to their function settings.

**Cross Type:** Allows you to search for data according to cross counting (CC) statistics. There are two mode options, including Cross In and Cross Out.

**Export:** You need to give a name to an exported file. Export current search results to an Excel file.

**System time:** Specifies the reference time for the selected report type.

**Mode:** Specifies whether to display graphs in the icon display area in a column or line chart.

**Display Area:** Displays search results in a graph.

**Search:** Used to search for data according to current settings.

### 8.7.4.4 - Heat Map Statistics

The heat map can intuitively present people distribution in temporal or spatial dimension.

- **Space heat map:** People activity degree in different areas in the view. Red indicates the densest area, meaning the highest activity degree, and blue indicates the lowest dense area.
- **Time heat map:** People activity degree in different times in the view. The Y axis value is the index calculated based on the number of people and the duration of stay. The higher the value is, the higher the activity degree will be. It does not represent the number of people.

The smart camera must be equipped with a memory card with free space in which heat map information will be stored. The screen is shown in the figure below.

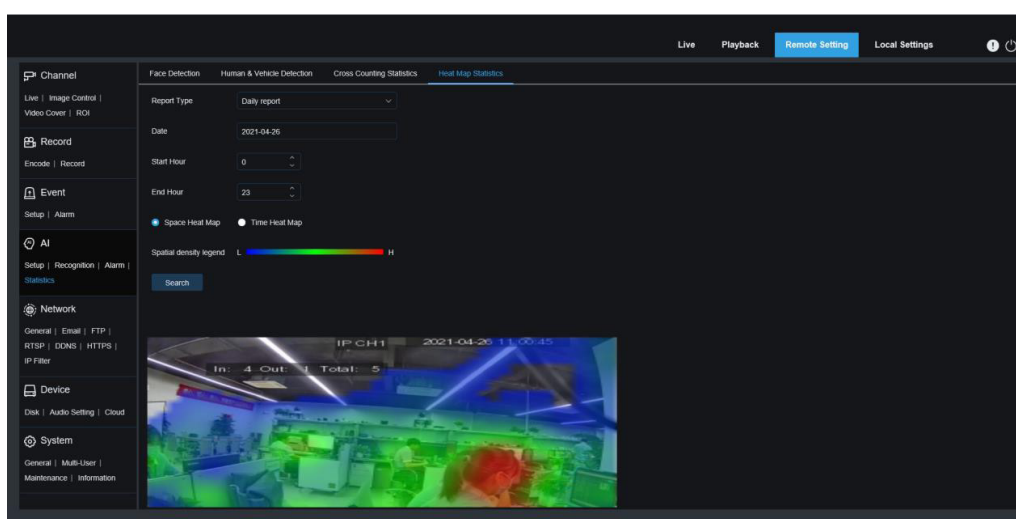

**Report Type:** The options include Daily report, Weekly report, Monthly report, and Annual report.

**Date:** Specifies the reference date for data search.

**Start Hour:** This option is available only for Daily report and used to set the hour to start searching.

**End Hour:** This option is available only for Daily report and used to set the hour to end searching.

**Mode:** Specifies the data display mode. There are two mode options including graph and table.

**Display Area:** Displays the change frequency of monitored areas as a graph, and displays the change frequency of monitored areas in different time periods as a table.

**Search:** Used to search for data according to current settings.

## 8.8 - Thermal

### 8.8.1 - Fire detection

In order to reduce fire safety hazards, fire point detection functions are set up in areas where fire safety hazards may exist.

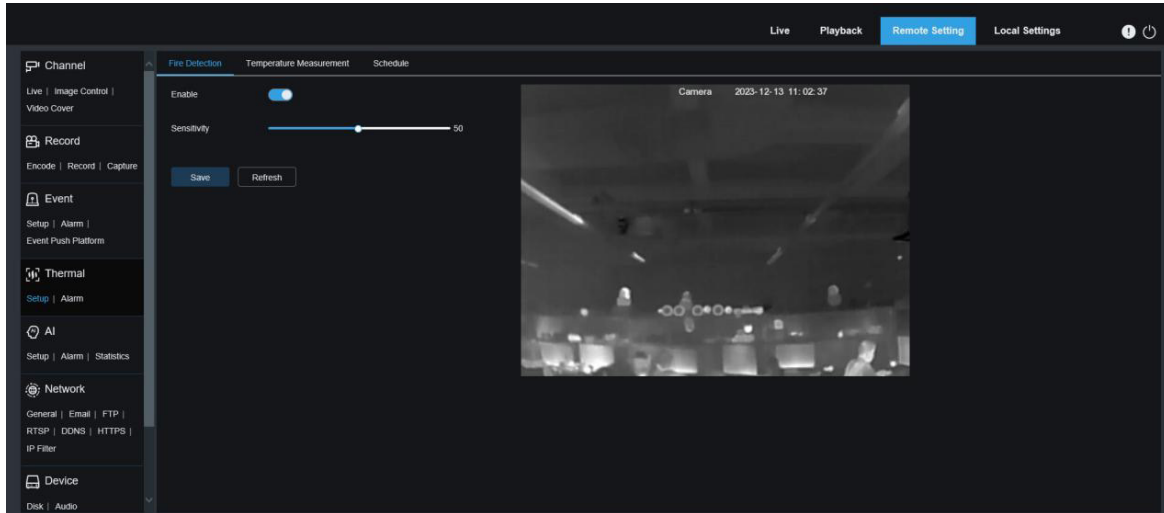

**Enable:** Enable or disable fire detection.

**Sensitivity:** Set the sensitivity of fire detection. The lower the sensitivity, the higher the temperature that needs to trigger the fire point detection alarm. The higher the sensitivity, the lower the temperature that triggers the fire detection alarm.



## 8.8.2 - Temperature measurement

It is used for real-time temperature monitoring of monitoring places. When the temperature exceeds the alarm threshold, the alarm is triggered to perform linkage.

EN

### 8.8.2.1 - Temperature measurement parameter setting

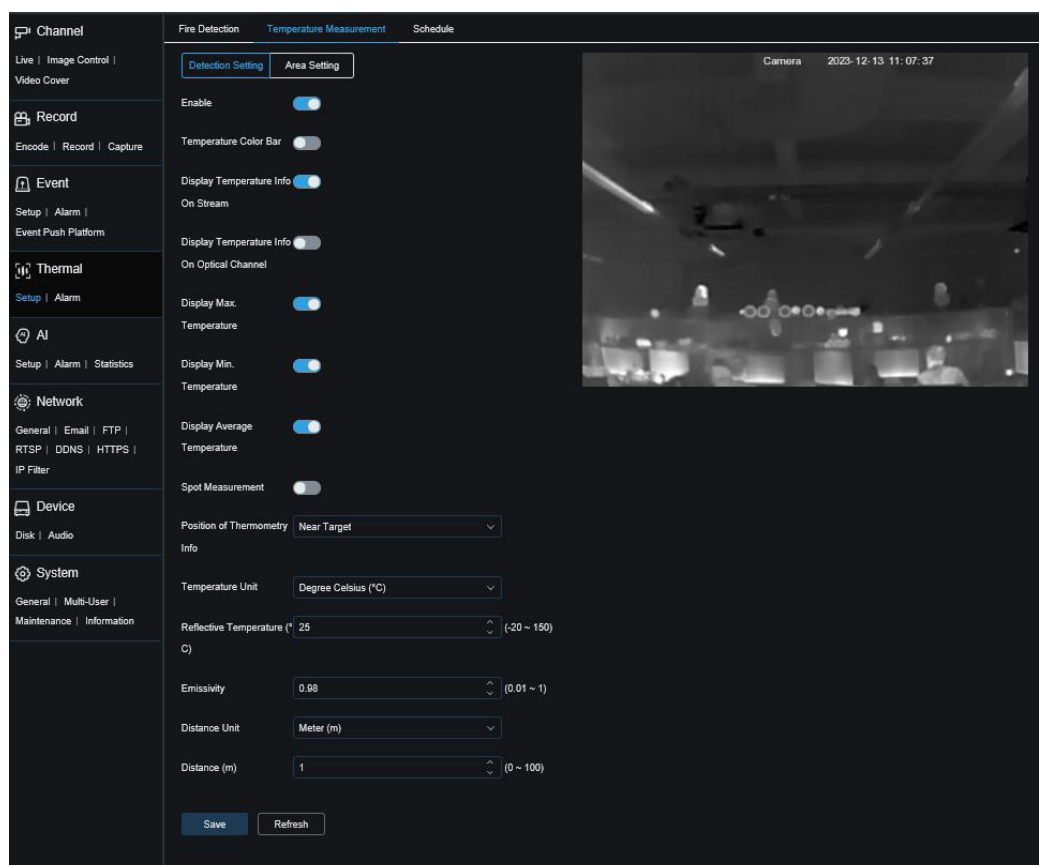

**Enable:** Enables or disables the temperature measurement function

**Temperature Color Bar:** When enabled, a color bar representing the different temperatures will be displayed on the right side of the thermal channel live view screen, with the maximum and minimum temperatures shown.

**Display Temperature Info On Stream:** Displays temperature information on the stream. When enabled, the temperature measurement area and the monitored temperature are displayed in the thermal channel live view screen.

**Display Temperature Info On Optical Channel:** Display temperature information on the optical channel. When enabled, the temperature measurement area and the monitored temperature are displayed simultaneously on the optical channel live view screen.

**Display Max. Temperature:** Display the maximum temperature. When turned on, the maximum temperature will be displayed in the preview screen, and the switch for displaying temperature information needs to be turned on first.

**Display Min. Temperature:** Displays the minimum temperature. When turned on, the minimum temperature will be displayed in the preview screen, you need to turn on the switch of displaying temperature information first.

**Display Average Temperature:** Displays the average temperature. When turned on, the average temperature will be displayed in the live view screen, and you need to turn on the switch for displaying temperature information first.

**NOTE:** If the temperature measurement area is ruled by a point, only the average temperature of the point will be displayed, and the maximum and minimum temperatures will not be displayed.

**Spot Measurement:** Single point temperature measurement. Once switched on, in the preview screen of the thermal channel, click on any area with the left mouse button to perform a single point measurement.

**Position of Thermometry Info:** Position of thermometry info. You can set the position of the temperature information in the preview screen.

**Near Target:** Temperature information is displayed next to the rules of each monitoring area.

**Top Left:** Temperature information is displayed in the top left corner of the preview screen.

**Temperature Unit:** Temperature Units. Set the units in which temperature information is displayed, including Celsius, Fahrenheit, and Kelvin temperature units.

**Reflective Temperature:** Set the ambient temperature of the camera.

**NOTE:** Reflected temperature refers to the ambient temperature reflected by the surface of the object being measured. When thermal radiation is reflected on the surface of an object, it will be affected by the ambient temperature. The reflected temperature is the temperature of the reflected thermal radiation.  
(The role of reflected temperature is to help the thermal camera accurately measure the temperature of an object's surface. In thermal radiation measurement, the infrared radiation received by the camera includes both radiation emitted from the object itself and reflected radiation from the environment. By measuring the ambient temperature, it is possible to distinguish between the thermal radiation emitted by the object and the thermal radiation reflected from the environment, and thus accurately calculate the surface temperature of the object.)

**Emissivity:** Set the appropriate emissivity according to the type of temperature target being measured. (See Appendix A for the emissivity of common substances).

**NOTE:** Emissivity is the ability of the surface of the object being measured to emit infrared radiation. Its role is to affect the accuracy of the thermal camera to measure the surface temperature of the object. Different emissivity result in different degrees of reflection and absorption of infrared radiation by the object, which can lead to deviations in the measurement results.

**Distance Unit:** Includes both metre and inch options.

**Distance:** Indicates the straight line distance between the temperature target to be measured and the device, which should be set according to the actual situation.

## 8.8.2.2 - Temperature measurement area setting

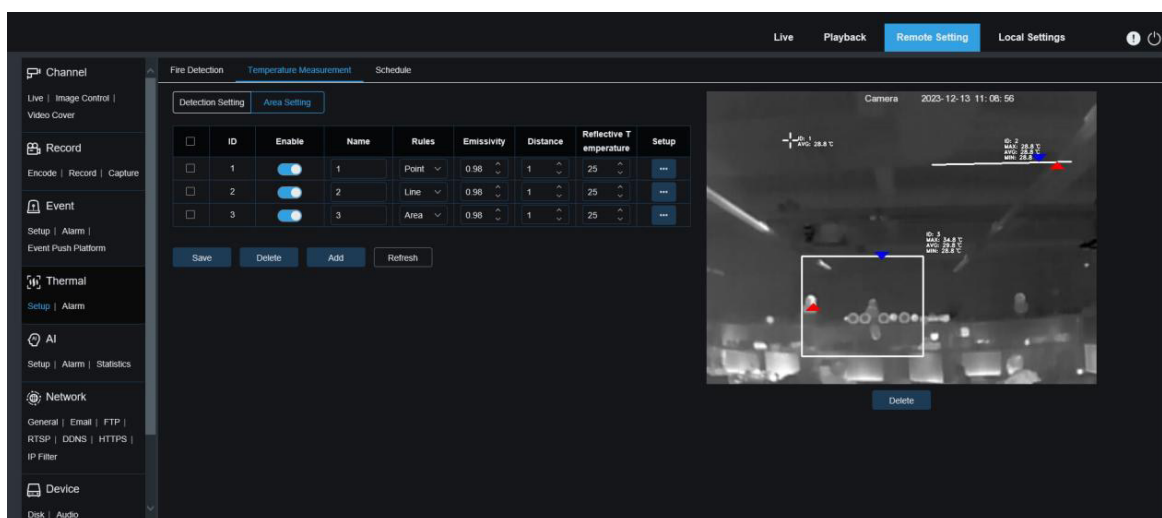

### Set temperature measurement area:

1. Click Add to add temperature rules, the maximum number of temperature rules is 20.
2. Select a temperature rule and enable it by Enable.
3. Customize the name of the rule in the Name column.
4. Select temperature rules, including point, line and area, you can draw the rules and determine the temperature measurement location on the right side of the configuration screen, tick the rule and click Delete to delete the drawn temperature rules at the bottom of the configuration screen.

**Spot Temperature Measurement:** Click anywhere in the configuration screen on the right to indicate temperature measurement of the selected spot. The preview screen will show the rule and average temperature information for the point.

**Line Temperature Measurement:** Click anywhere in the right configuration screen, hold down the mouse and drag it to another location to draw a temperature measurement rule line, which indicates that the temperature measurement will be performed for the position on the line segment. Click the tick box of the rule line to adjust the length, angle and position of the rule line. The preview screen displays the rule and temperature information for that temperature measurement line segment.

**Regional temperature measurement:** Click anywhere on the configuration screen on the right, hold down the mouse and drag it to another location to draw a quadrilateral temperature measurement rule area, indicating that the temperature of the area will be measured. Click the check box of the rule area to adjust the size and position of the rule area. The rules and temperature information of the temperature measurement area will be displayed in the preview screen.

5. Set the appropriate emissivity according to the type of temperature target being measured.
6. Set the straight-line distance between the temperature target and the device.
7. Set the ambient temperature of the camera.
8. Click to enter the alarm rule setting page and set the alarm rules corresponding to each temperature measurement rule.

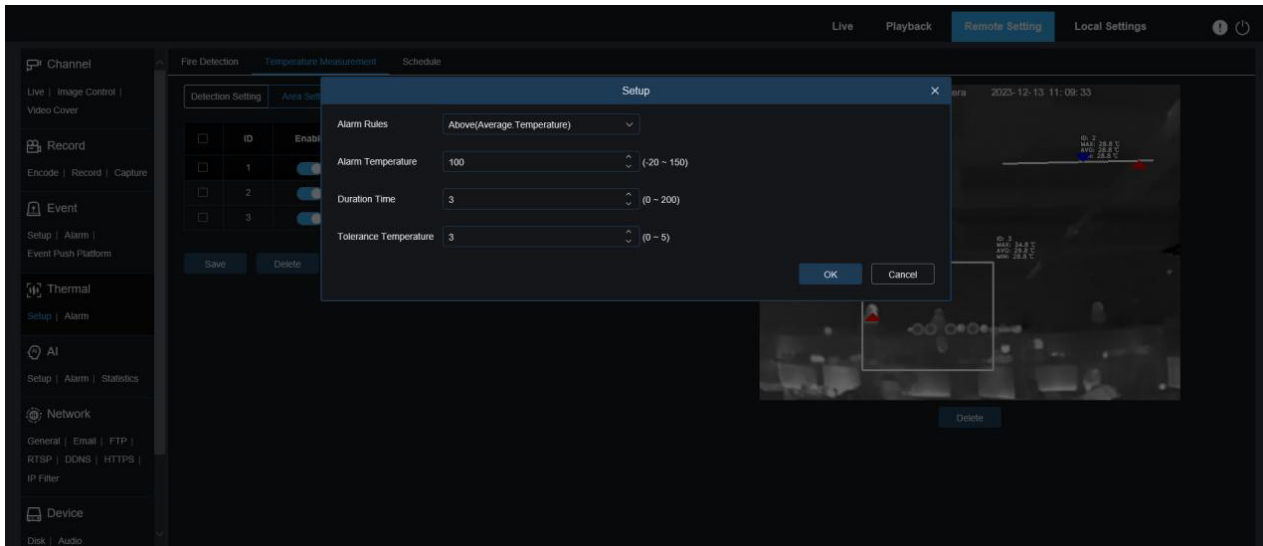

**Alarm Rules:** There are the following alarm rules, including Above

**(Max. Temperature):** The maximum temperature is greater than.

**Below (Max. Temperature):** The maximum temperature is less than.

**Above (Min. Temperature):** The minimum temperature is greater than.

**Below (Min. Temperature):** The minimum temperature is less than.

**Above (Average Temperature):** The average temperature is greater than.

**Below (Average Temperature):** The average temperature is less than.

**Above (Temperature Difference):** The difference between high and low temperature is greater than.

**Below (Temperature Difference):** The difference between high and low temperature is less than.

The alarm rules for point temperature measurement rules are only **Above**

**(Average Temperature):** The average temperature is greater than and Below

**(Average Temperature):** The average temperature is less than.

**Alarm Temperature:** Set the temperature threshold for alarm.

**Duration Time:** Indicates the time during which the temperature of the measured object continues to exceed the temperature threshold. If this time is exceeded, the alarm will be triggered.

**Tolerance Temperature:** Tolerance temperature to prevent temperature fluctuations affecting the alarm effect.

**EG:** The alarm rule selects the average temperature to be greater than the alarm temperature is set to 40°C, and the duration is set to 3s, the tolerance temperature is set to 3°C. When the average temperature of the area monitored by this temperature measurement rule is greater than 40°C and the duration exceeds 3 seconds, an alarm is triggered. When the average temperature of the monitored area is less than or equal to 37°C, the alarm is canceled.

9. Check the temperature measurement rule and click **Delete** to delete it.

### 8.8.3 - Thermal alarm schedule

When the thermal Alarm Schedule function is turned on, the device performs the thermal fire point detection or temperature measurement alarm function according to the time period set in the schedule.

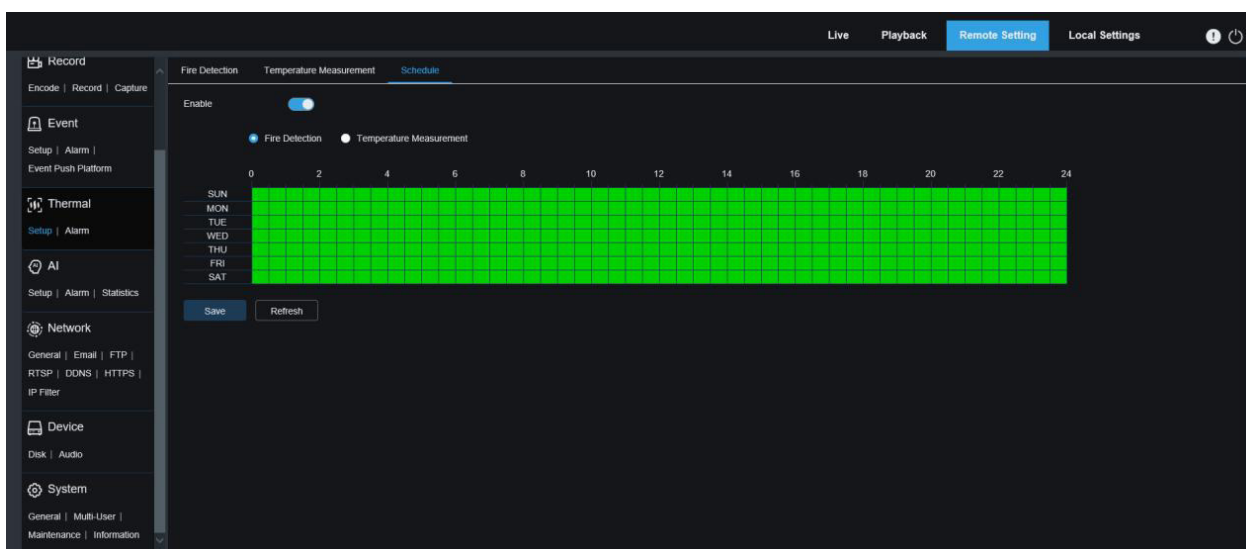

## 8.8.4 - Thermal alarm schedule

Set the thermal fire point detection or temperature measurement function, and the linkage actions to be executed after the alarm is triggered.

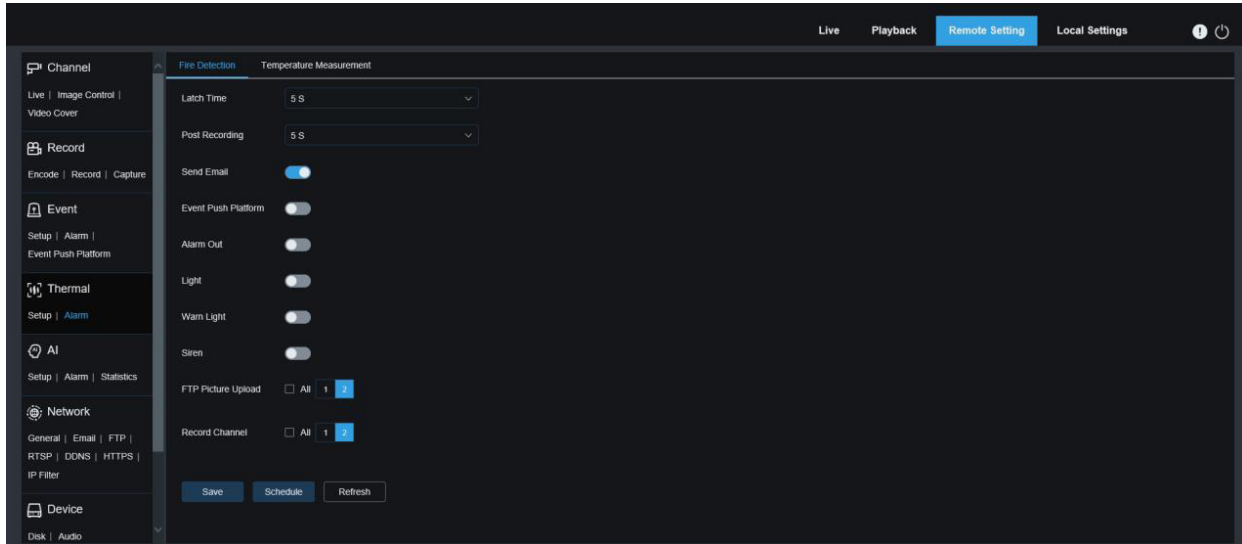

**Latch Time:** Used to set the duration for triggering an external alarm when motion is detected.

**NOTE:** The camera needs to support I/O output function, and the working time is controlled by the corresponding schedule.

**Post Recording:** You can set the duration of continuous recording after an event occurs. The options include 5s, 10s, 20s, and 30s. The default duration is 5s, but the maximum duration can be set to 30s.

**Send Email:** You can have the device automatically send you an email when it detects motion.

**Event push Platform:** If this option is set to ON, this type of information will be pushed to the client when an alarm is triggered.

**Alarm Out:** Latch Time setting enable switch. If the device does not support the I/O output function, it will not be displayed.

**Light:** If this option is set to ON, the white light will be turned on for deterrence when an alarm is triggered.

**Warn Light:** If this option is set to ON, the warning light will be turned on for deterrence when an alarm is triggered.

**Siren:** If this option is set to ON, the siren will be turned on for deterrence when an alarm is triggered.

**FTP Picture Upload:** After triggering the alarm, according to the selected channel upload alarm images to FTP server.

**Record Channel:** According to the selected channel when an alarm is triggered, this type of video will be recorded.

**Schedule:** Set the scheduled time when an alarm acts. A series of alarm actions are triggered only within the scheduled time.

## 8.9 - Network Settings

This menu allows you to configure network parameters, such as, PPPoE, DHCP, and SNMP, of which DHCP is the most common. In most cases, the network type is DHCP unless the static IP address is set manually. If you need an authenticated username and password to connect to the network, select PPPoE.

EN

### 8.9.1 - Basic Settings

#### 8.9.1.1 - General

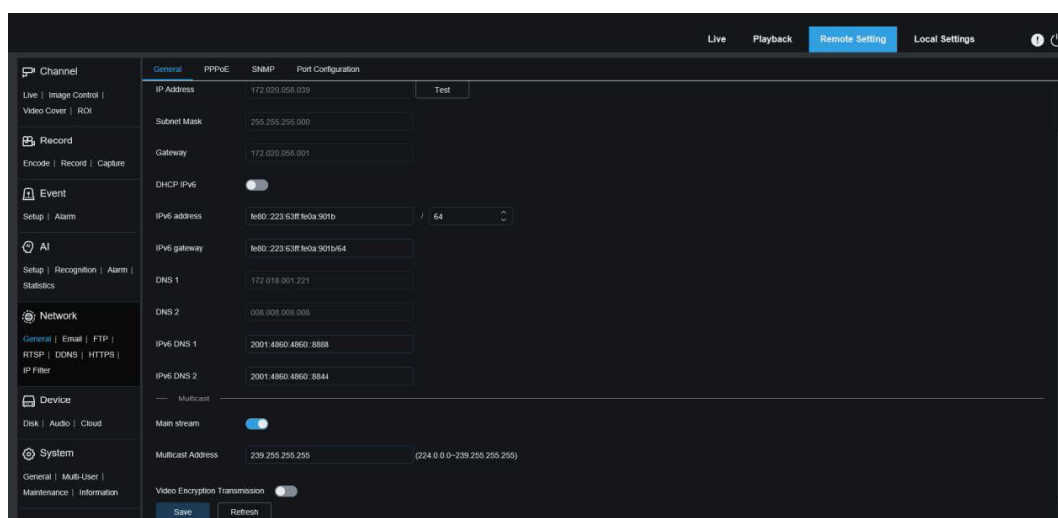

To connect to a router that allows DHCP, check the DHCP box. The router will automatically assign all network parameters to the device. You can also choose to manually set the following parameters for the network:

**IP Address:** The IP address is the identifier of IPC on the network. It consists of four numbers between 0 and 255 separated by periods. For example, "192.168.001.100".

**Subnet Mask:** A subnet mask is a network parameter that defines the range of IP addresses that can be used in the network. If the IP address is likened to the street you live on, then the subnet mask is the community. A subnet address also consists of four numbers separated by periods, for example, "255.255.000.000".

**Gateway:** This address allows IPC to access the network. The format of a gateway address is the same as that of an IP address, for example, "192.168.001.001".

**IPv6 Address:** The IPv6 address is the identifier of IPC on the network. It consists of eight numbers between 0 and FFFF, separated by colons, for example, "ABCD:EF01:2345:6789:ABCD:EF01:2345".

**DNS1/DNS2:** DNS1 is the active DNS server and DNS2 is the standby DNS server. Usually you just need to enter the DNS1 server address.

**Main Stream:** If this option is enabled, the main stream can be used for multicast.

**Multicast Address:** Specifies a multicast address. A third party player can request the camera to send a multicast media stream through the RTSP protocol.

**Video Encryption Transmission:** Indicates audio/video encryption transmission. If the IPC is capable of warning you of repeated IP addresses in the same network segment, when IP addresses are repeatedly used, the following message will pop up when you click the Test icon:



The screenshot shows a dark-themed configuration interface. It features two input fields: 'IP Address' with the value '172.020.058.037' and 'Subnet Mask' with the value '255.255.255.000'. A 'Test' button is located to the right of the IP Address field. Below the IP Address field, a red error message reads 'The address is used'.



## 8.9.1.2 - PPPoE

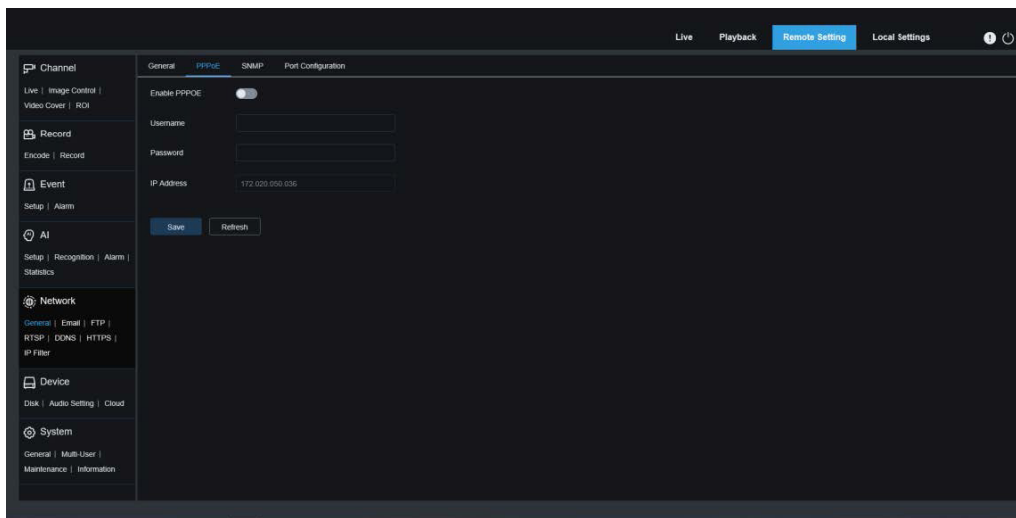

EN

This is an advanced protocol that allows the IPC to connect to the network more easily via DSL modems. Turn on the "Enable PPPoE" box and then enter the username and password of PPPoE. Click the "Apply" to save data. The system will restart to take PPPoE settings into effect.

### 8.9.1.3 - SNMP

Simple Network Management Protocol (SNMP) is a standard application layer protocol that is designed to manage nodes such as servers, workstations, routers, switches, and HUBS over IP networks.

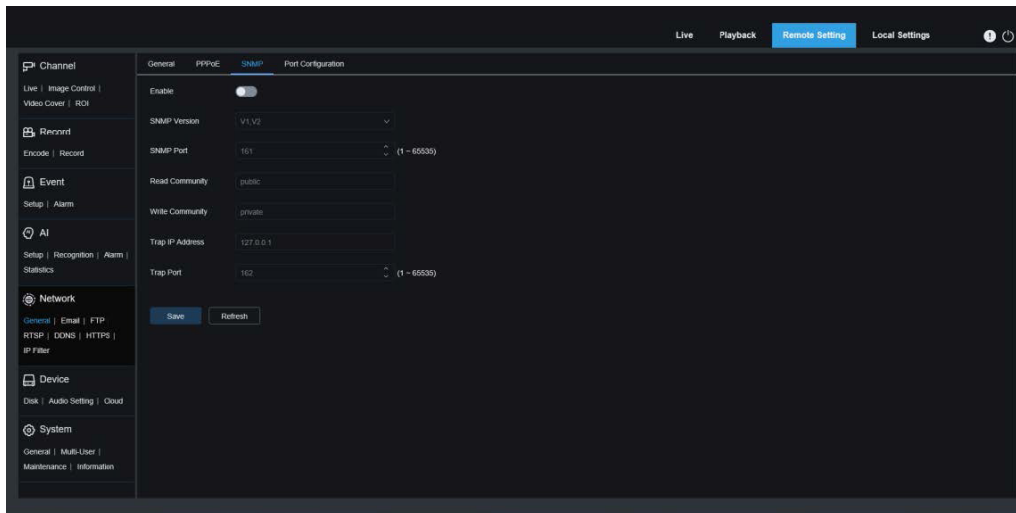

**Enable:** Used to turn on or off SNMP.

**SNMP Version:** Specifies the version of the SNMP server. The options include V1, V2 and V1, V2, and V3.

**SNMP Port:** Specifies the port number of the SNMP server.

**Read Community:** Specifies the Read Community value of the SNMP server.

**Write Community:** Specifies the Write Community value of the SNMP server.

**Trap IP Address:** Specifies the Trap IP address of the SNMP server.

**Trap Port:** Specifies the Trap port number of the SNMP server.

## 8.9.1.4 - Port Settings

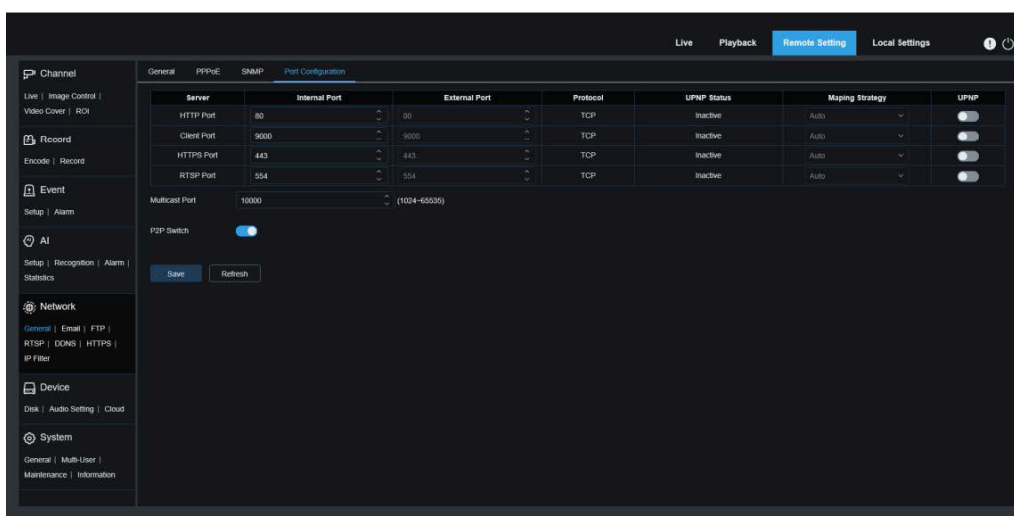

**Web Port:** This is the port you use to remotely log in to the IPC (for example, using a web client). If port 80 is already used by other applications, change the port number.

**Client Port:** This is the port through which the IPC will send messages (for example, using a mobile application). If default port 9000 is already used by other applications, change the port number.

**RTSP Port:** The default port number is 554. If it is already used by other applications, change the port number.

**HTTPS:** It is an HTTP channel aiming for security. On the basis of HTTP, transmission encryption and identity authentication are used to ensure the security of transmission.

**UPnP:** To remotely log in to the device from a web Client, perform port forwarding on the router. Enable this option if your router supports UPnP. In this case, you do not have to manually configure port forwarding on the router. If your router does not support UPnP, make sure that port forwarding is done manually on your router.

**Multicast port:** Specifies a multicast port.

**P2P Switch:** P2P is ineffective if this switch is turned off.

## 8.9.2 - SNMP

This menu allows you to configure email settings. Complete these settings if you want to receive system notifications via email when an alarm is triggered and your hard drive is full.

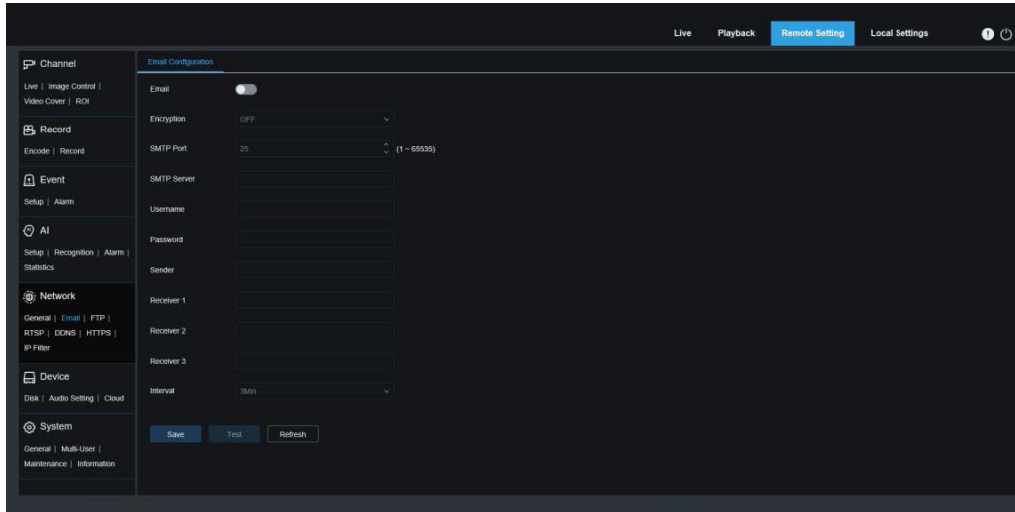

**Email:** Used to turn on or off email.

**Encryption:** Enable this option if your email server requires SSL or TLS authentication. Set it to Automatic if you are not sure.

**SMTP Port:** Specifies the SMTP port number of the email server

**SMTP Server:** Specifies the SMTP server address.

**UserName:** Specifies your email address.

**Password:** Specifies your email password

**Receiver 1~3:** Specifies the email address from which you want to receive event notifications from the IPC.

**Interval:** Specifies the interval between notification emails on the IPC.

To ensure that all settings are correct, click **Test Email**. The system will send an email to your inbox. If you receive a test email, the configuration parameters are correct.

## 8.9.3 - FTP Server Settings

This menu enables you to enable the FTP server, through which you can view pictures and videos uploaded from the IPC to your FTP server.

EN

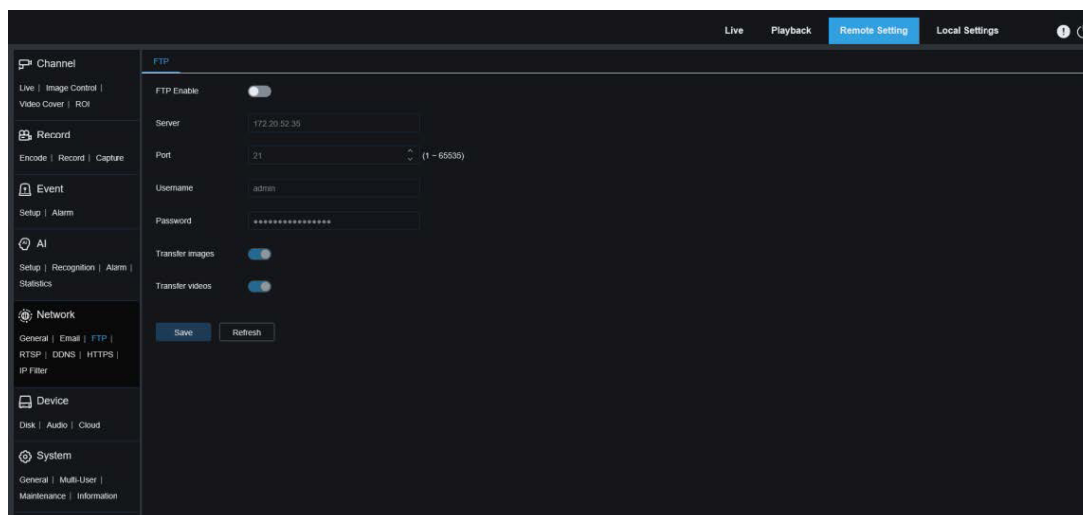

**FTP Enable:** You can click this icon to enable the FTP feature.

**Server:** Specifies the IP address or domain name of your FTP server.

**Port:** Specifies the port number of your FTP server.

**Username/ Password:** Specifies the username and password of your FTP server.

**Transfer images:** When this option is turned on, alarm images will be uploaded to the FTP server. Otherwise, only alarm texts will be uploaded.

**Transfer Videos:** When this option is turned on, alarm videos will be uploaded to the FTP server.

## 8.9.4 - RTSP Settings

Real Time Streaming Protocol (RTSP), RFC2326, is an application layer protocol in the TCP/IP protocol architecture. This protocol defines how one to many applications can efficiently transfer multimedia data over IP networks. You can view real time images using a video player.

**RTSP Enable:** Used to turn on or off the RTSP. This protocol is available only when it is turned on.

**Anonymous Login:** Allows you to log in as a anonymous user. Authentication is not required for using this protocol if this option is turned on.

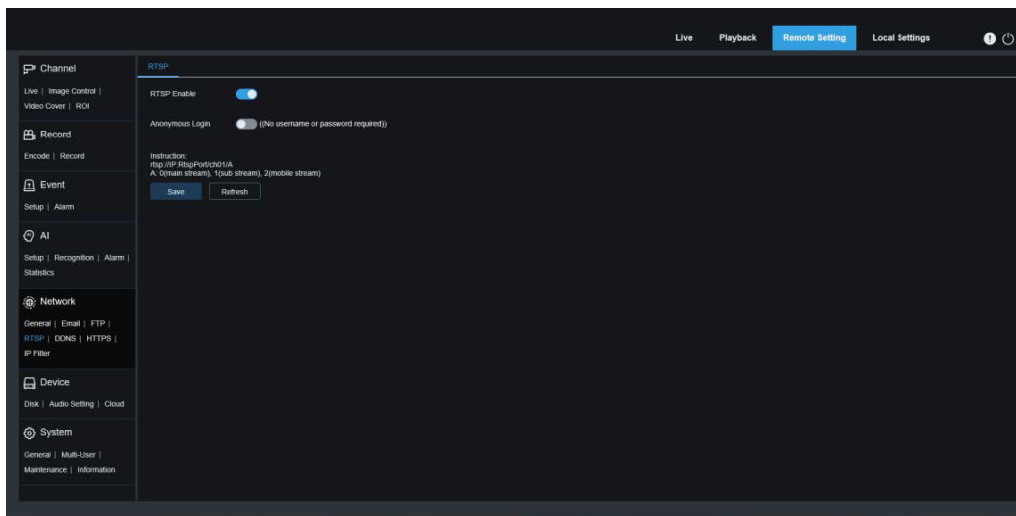

## 8.9.5 - Dynamic Domain Name Settings

This menu allows you to configure DDNS settings. DDNS provides a static address to simplify remote connection to the IPC. To use DDNS, you first need to sign up an account on the webpage of the DDNS service provider.

EN

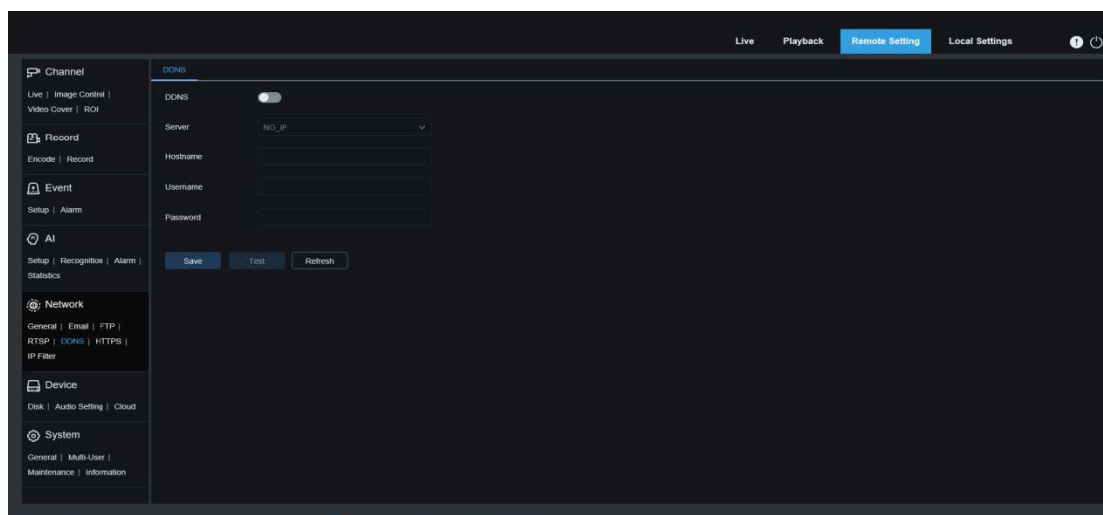

**DDNS:** Used to turn on or off DDNS.

**Server:** Specifies your preferred DDNS server (DDNS\_3322, DYNDNS, NO\_IP, or even CHANGEIP, DNSEXIT).

**Hostname:** Specifies the domain name you created on the webpage of the DDNS serviceprovider. This is the address you type in the URL bar when you want to connect remotely to the IPC from your PC.

**User/Password:** Specifies the user name and password obtained when you create an account on the webpage of the DDNS service provider.

Enter all parameters and then click **Test DDNS** to test DDNS settings. If the test result is "Unreachable or DNS error", check whether the network works normally or the DDNS information is correct.

## 8.9.6 - HTTPS Settings

This menu allows you to set HTTPS. You can connect your device over HTTPS.

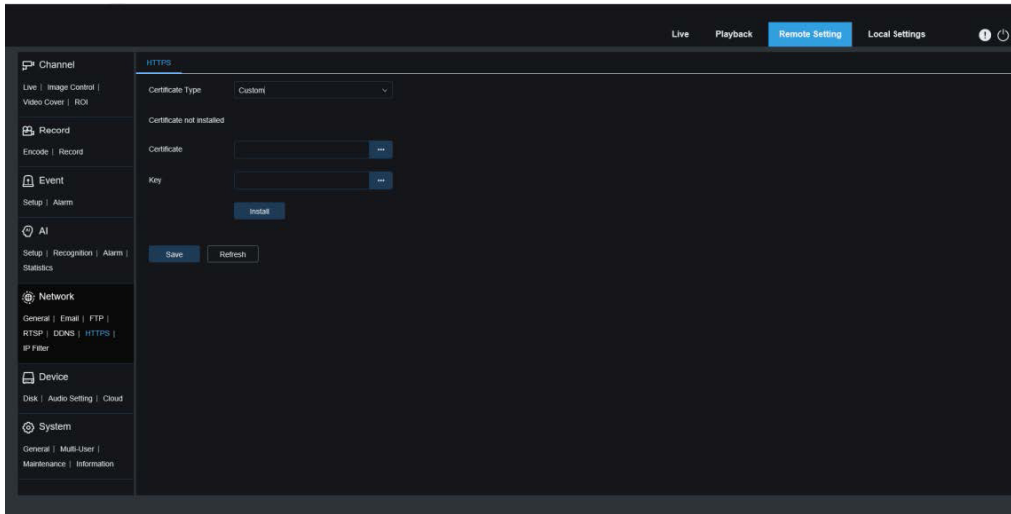

**Certificate Type:** There are two options, including default and custom. The Custom option allows you to connect devices using your own certificate.

**Certificate:** Select a custom certificate when the Custom option is selected.

**Key:** Select a custom key file when the Custom option is selected.



## 8.9.7 - IP Filter

The IP filter can be used to set the allow list and block list of devices to be connected.

EN

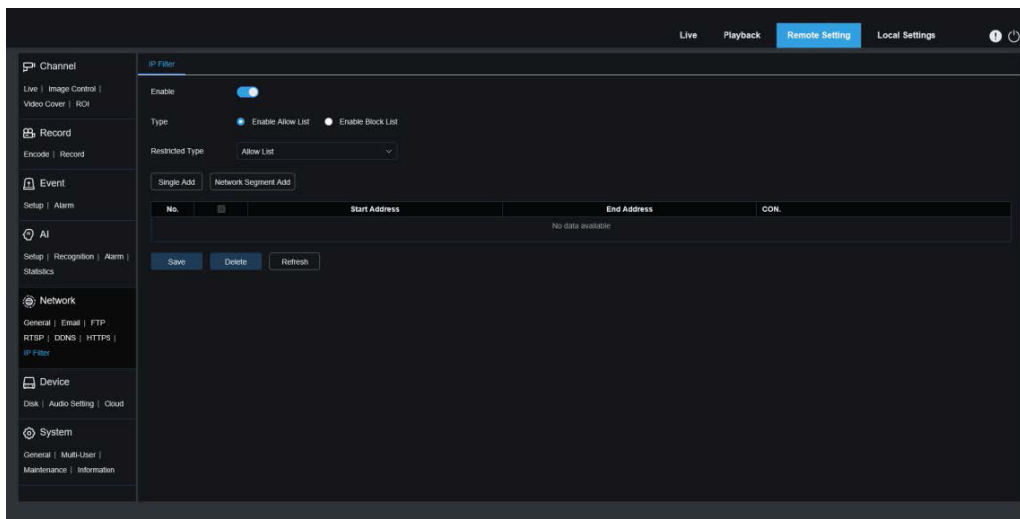

**Enable:** Used to turn on or off the IP filter. You can choose to enable the block list or allow list if this option is turned on.

**Restricted Type:** Used to select the list to be set (block list or allow list).

**Start Address:** Specifies the start address.

**End Address:** Specifies the end address.

## 8.10 - Device Management

### 8.10.1 - Disk Management

This menu allows you to check and configure the internal TF card. Formatting is required only for initial access and when a new TF card is used.

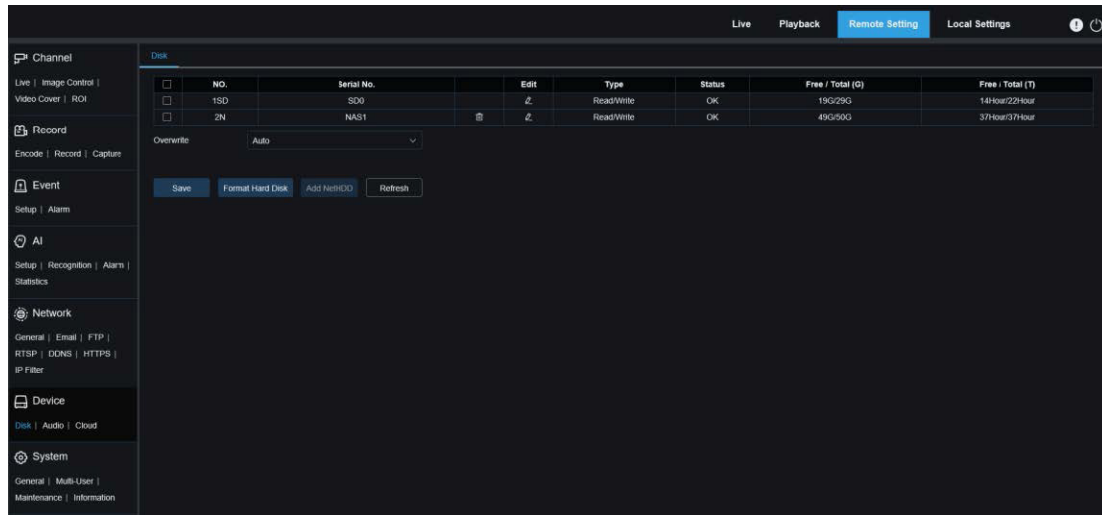

1. **Format Hard Disk:** Select the TF card to be formatted, and then click Format TF Card. To start formatting, enter your username and password and then click OK.
2. **Overwrite:** Use this option to overwrite old records in the TF card when the TF card is full. If **Auto** is selected, the oldest data will be automatically overwritten when the TF card is full. Select **OFF** if you do not want to overwrite any old videos. If this function is disabled, check the status of the TF card periodically to ensure that the TF card is not full.
3. **ADD NetHDD:** This function allows you to add a network HDD. After a network HDD (NAS) is configured, you can connect the NAS to the Internet to record channel videos or capture images. The AI face database can only be stored in the HDD.

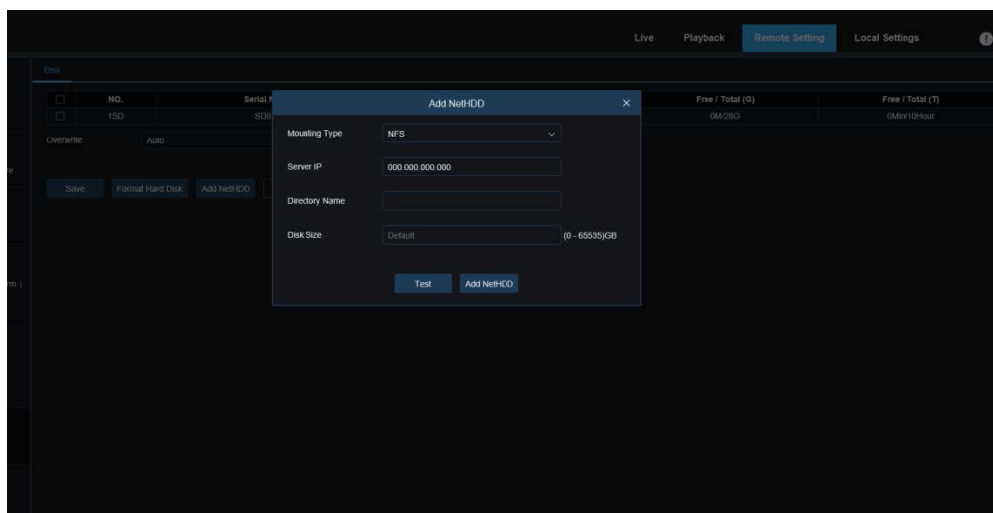

**Mounting type:** There are two options, including NFS and SMB/CIFS. Among them, NFS does not need username and password, but SMB/CIFS needs.

**User Name:** Specifies the username of NAS (unavailable in NFS mode).

**Password:** Specifies the password of NAS (unavailable in NFS mode).

**Server IP:** Specifies the IP address of NAS.

**Directory Name:** Specifies the folder where you want to store data in the NAS.

**Disk Size:** Specifies the size of the network HDD.

**Test:** Used to test the connectivity of NAS.

**Add NetHDD:** You can click this option to add NAS.

## 8.10.2 - Audio Management

This menu is used to set the volume of your device.

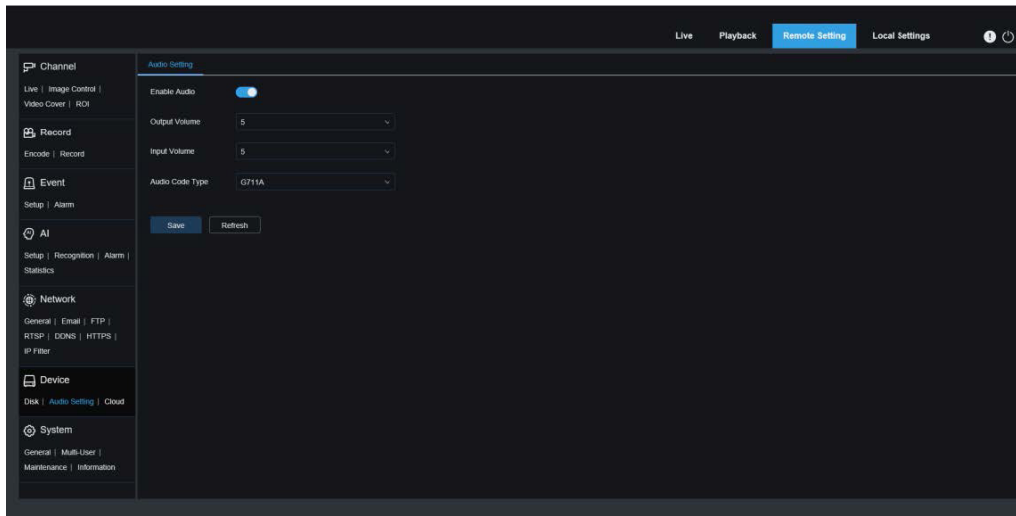

**Enable Audio:** Used to turn on or off audio.

**Output Volume:** Specifies the volume of output audio.

**Input Volume:** Specifies the volume of input audio.

**Audio Code Type:** Specifies the audio decoding type. There are two options, including G711A and G711U.

### 8.10.3 - Cloud Storage Settings

Your device can upload snapshots or videos to the cloud service through Dropbox, a free service that enables you to easily store and share pictures.

EN

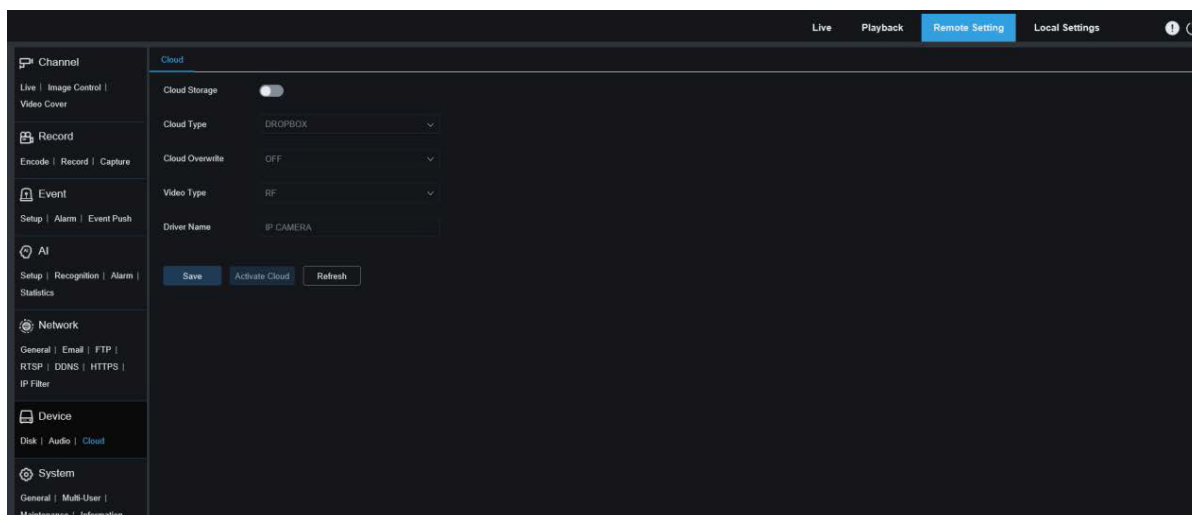

Before starting the cloud storage service, you are advised to create a Dropbox account with your email address and password. Then, visit [www.dropbox.com](http://www.dropbox.com), enter your email address and password, and click Login button after agreeing to the terms and conditions.

**Cloud Storage:** Used to turn on or off cloud storage

**Cloud Type:** There are two options, including Dropbox and Google Drive.

**Cloud Overwrite:** Specifies the over write frequency of cloud storage.

**Video Type:** Specifies the format of videos uploaded to the cloud service.

**Driver Name:** Specifies the name of the folder where the channel videos and images are stored.

**Activate Cloud:** You can click this button to activate this function. A moment later, the page automatically redirects to the Dropbox link. You can establish the association simply by entering correct username and password.

## 8.11 - System Settings

Here you can change system information such as date and time and regions, and change the password and permissions.

### 8.11.1 - General

#### 8.11.1.1 - Date and Time

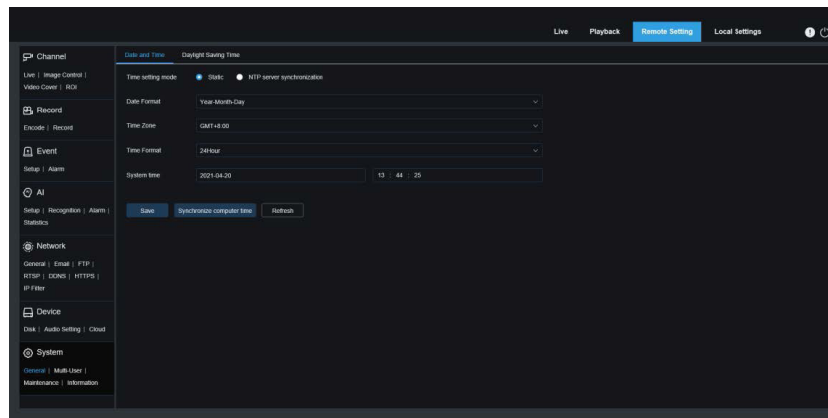

**Time settings mode:** There are two options including Static and NTP server synchronization. When Static is selected, you have to set the time manually. When NTP server synchronization is selected, the time will be synchronized to the network time.

**Date Format:** Specifies the date format.

**Time Zone:** Specifies the time zone associated with your region or city.

**Time Format:** Specifies your preferred time format.

**System Time:** You can click the box to change the date and time.

**Synchronizes computer time:** Here you can synchronize the time to the computer time. You cannot set the time manually if NTP server synchronization is selected.

**Sever Address:** Specifies the automatic time synchronization website.

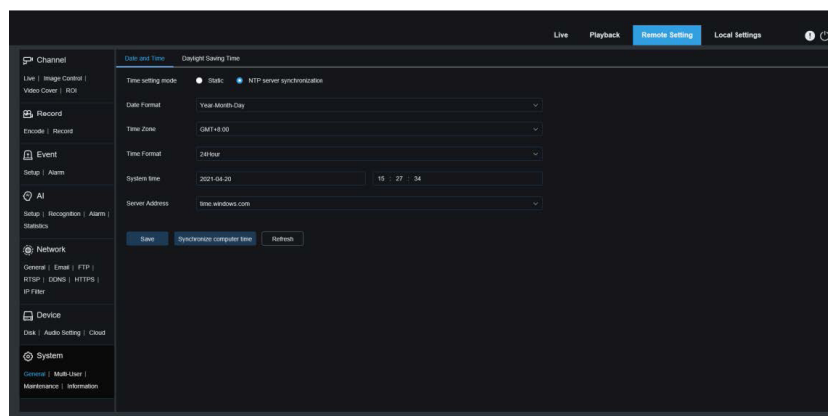

## 8.11.1.2 - Daylight Saving Time

The Daylight Saving Time (DST) function enables you to choose when to add daylight saving time to a specific time zone or region.

EN

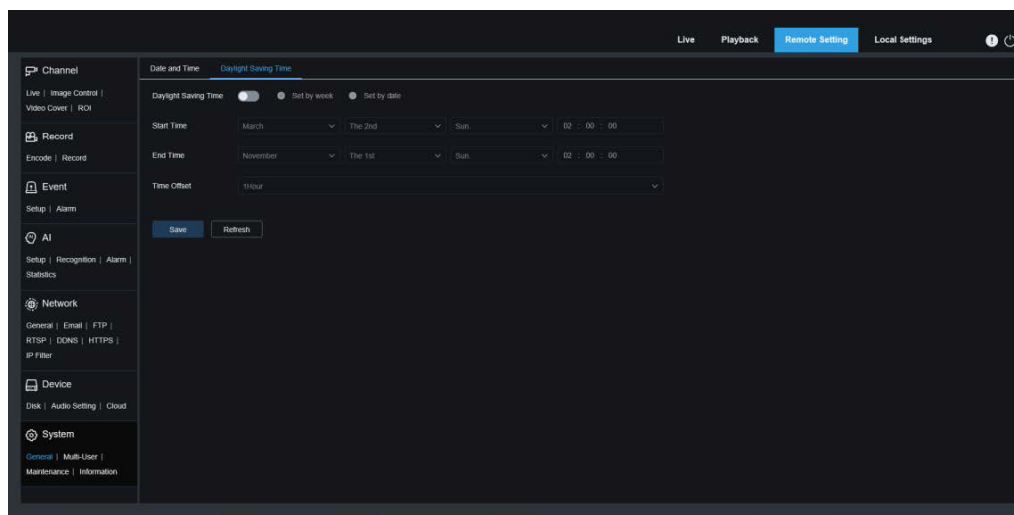

**Daylight Saving Time:** Turn on this option if DST is used in your time

**Set by week:** Specifies the month, weekday, and time when daylight saving time begins and ends, for example, 2AM on the first Sunday of a month.

**Set by date:** Specifies the date and time when daylight saving time begins and ends.

**Start Time / End Time:** Specifies the start time and end time of daylight saving time.

**Time Offset:** Specifies the time that daylight saving time adds to your time zone. This is the difference between Universal Time Coordinated (UTC) and your local time.

## 8.11.2 - Multi-user Management

This menu allows you to configure username, password, and permissions.

The system supports user types as follows:

### ADMIN

**System Administrator:** A system administrator can fully configure the system and can change administrator and user passwords as well as enable/disable password protection.

### USER

**Normal User:** A normal user can only access the preview, search, playback and other appropriate functions. You can set multiple users with different system access permissions.

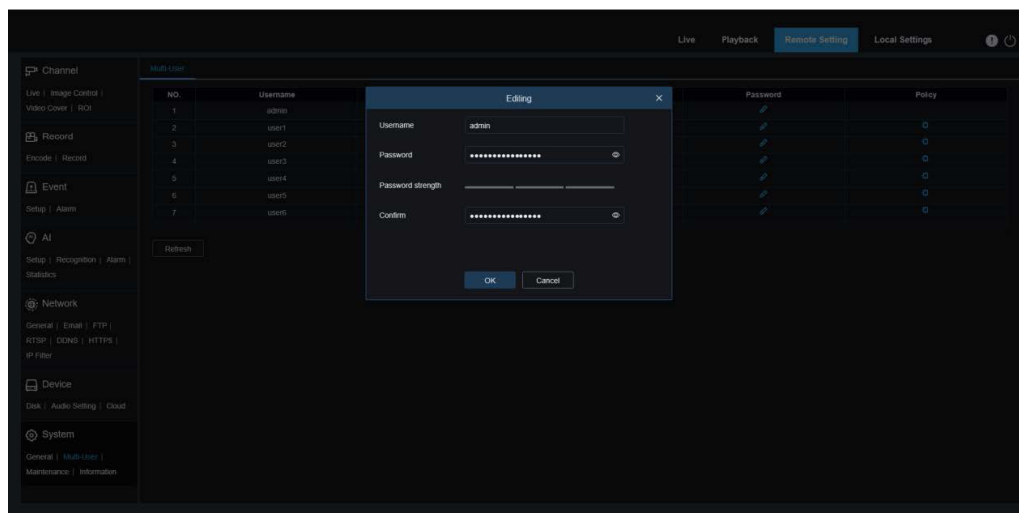
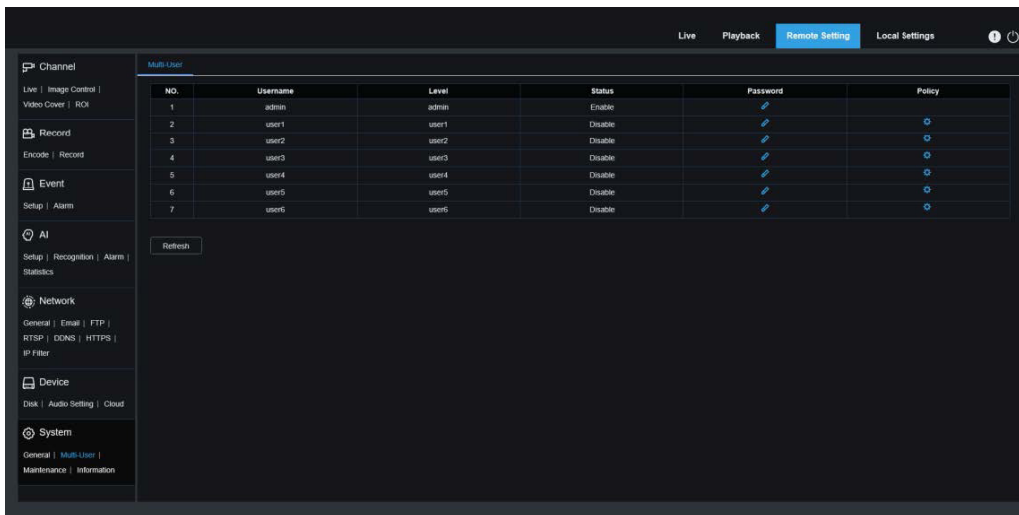

To change an administrator or user password, click the **Edit Password** icon. The password must be at least 8 characters long and a combination of numbers, letters, and symbols. Enter the new password again for confirmation. Save the new password. You will be asked to enter the old password for authentication.



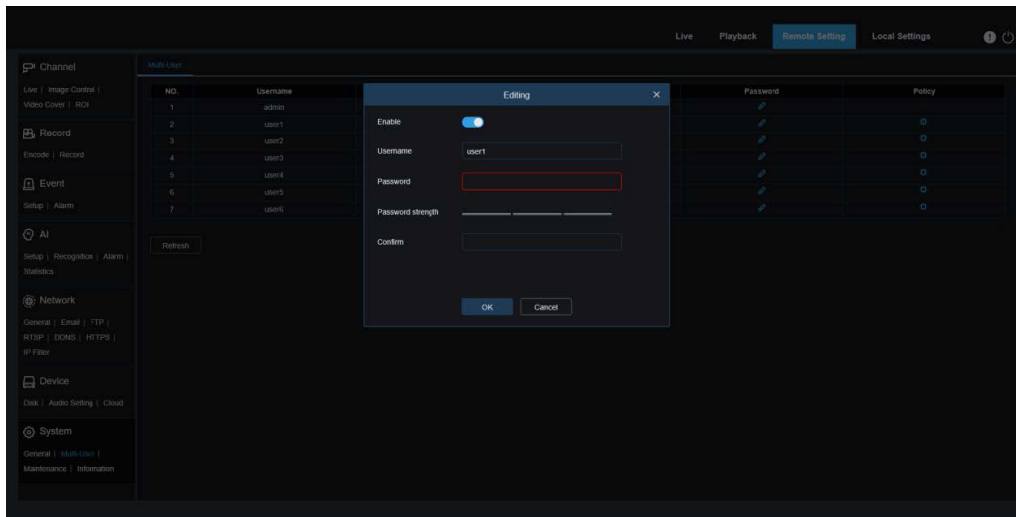

1. Select one of inactive users and click the **Edit Password** icon.
2. Turn on **Enable** to enable
3. Click **Username** to edit the
4. Click the field next to **Password** to enter your password.
5. Click the field next to **Confirm** to enter your confirm password.

Click **Save**. You will have to enter the administrator password for authentication.

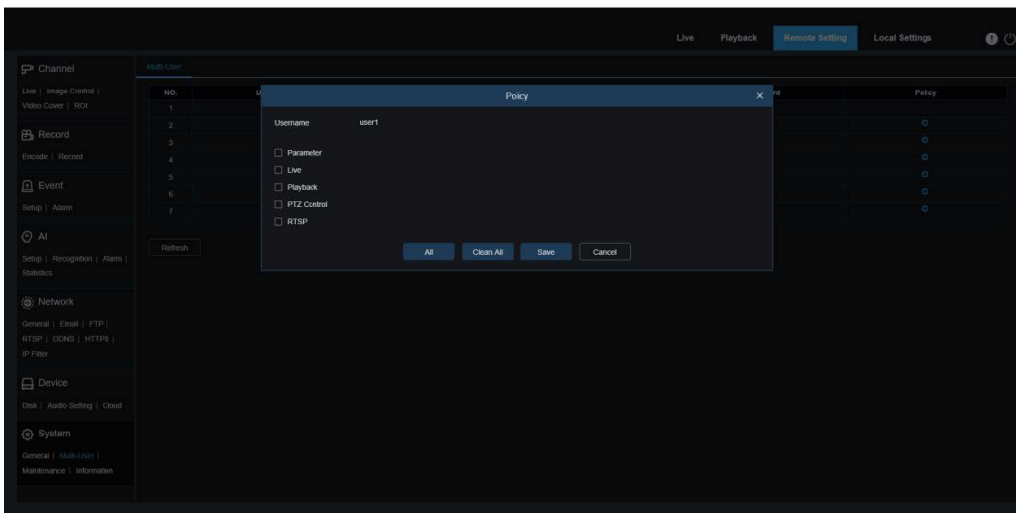

Set user permissions and check the boxes corresponding to the functions.

Click **All** to check all boxes.

Click **Clear** to clear all boxes.

## 8.11.3 - System Maintenance

This menu enables you to search for and view system logs, restore factory settings, upgrade the system, export and import system parameters, and configure automatic system restart.

### 8.11.3.1 - Log Management

The system log displays important system events, such as motion alarms and system warnings. You can easily import backup files in the system log to your computer within a set time range.

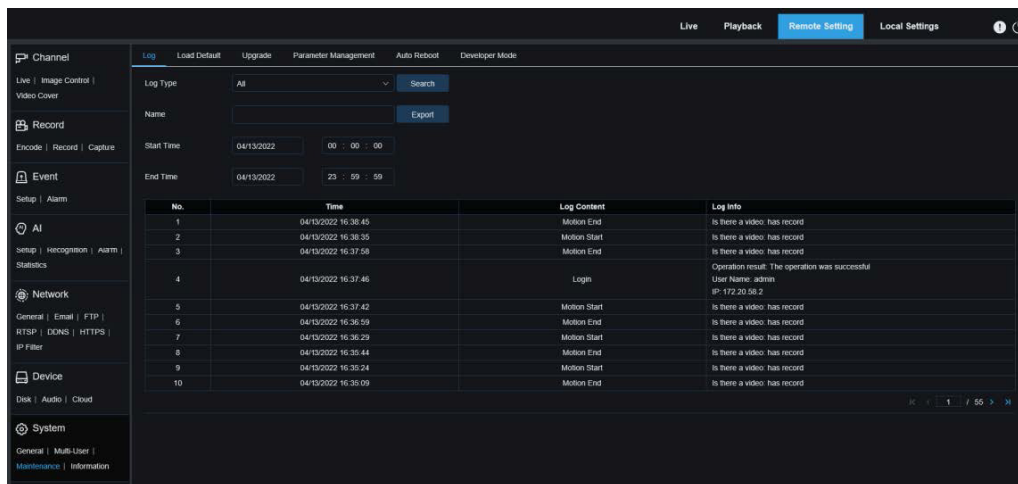

#### Log Search and Backup:

1. Click the field next to **Start Time** and select the start date and time from the on screen calendar.
2. Click the field next to **End Time** and select the end date and time from the on screen calendar.
3. Select the event type you want to search for from the drop down list next to **Log Type**, or select **All** to view the entire system log for the selected time range. The type options include: system log, configuration log, warning log, account log, recording log, storage log, and network log.
4. Select the event type you want to search for from the drop down list next to **Minor Type** (this menu is unavailable if ALL is selected for Log Type), or select **All** to view the entire system log for the selected time range. The type options include:
  - **System:** System settings, restart, automatic restart, upgrade, time settings, and NTP.
  - **Configuration:** IPC live control, private area settings, recording mode settings, recording plan settings, main stream settings, network settings, Substream settings, email settings, colour settings, motion detection settings, hard disk settings, multi user settings, NTP settings, image control , mobile stream settings, RTSP settings, IP filter settings, restore factory settings, audio settings, video tampering alarm settings, export settings, and import settings.
  - **Alarm:** Start of motion detection, end of motion detection, start of I/O alarm, end of I/O alarm, start of PID, end of PID, start of LCD, end of LCD, start of SOD, end of SOD, start of PD&VD, end of PD&VD, start of FD, end of FD, start of CC, end of CC, start of CD, end of CD, start of QD, end of QD, start of sound alarm, and end of sound alarm.

- **Account:** Log in, log out, and switch users.
  - **Recording:** Search, playback, and backup.
  - **Storage:** Formatting HDD, HDD full, and HDD error.
  - **User network:** Network disconnected, network online, network exception, and Network Mode changed.
5. Click Search
  6. Browse system logs from the selected time range:
  7. Use the **⏪ < / > ⏩** button in the lower right corner of the menu to switch between pages of system log events.

Enter the name of the exported file in the field next to **Name**.

Click **Export** to create the backup of system logs.

### 8.11.3.2 - Load Default

Reset the device to factory settings. You can choose to reset all the settings at a time, or the settings on a specific menu.

**NOTE:** Restoring the default Settings will not delete videos and snapshots stored in the memory card.

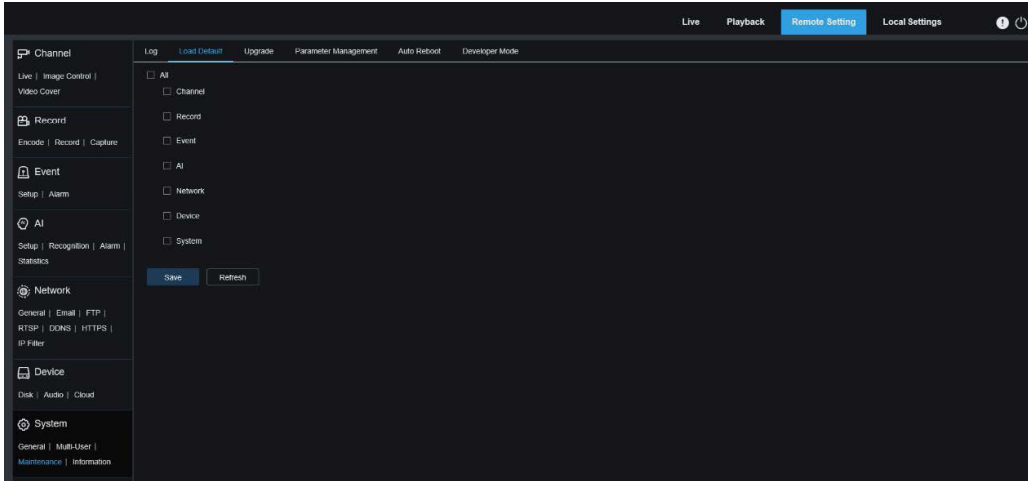

Select the item to restore, or **All** to select all items. Click **Save** to load the default settings for the selected items.

### 8.11.3.3 - System Upgrade

This menu allows you to upgrade firmware.

EN

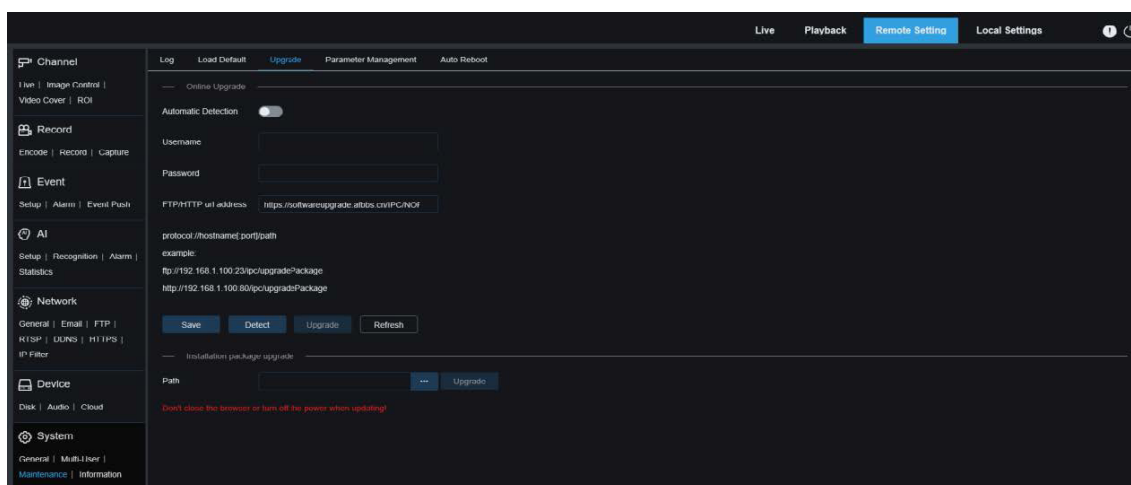

**Automatic Detection:** Used to enable automatic detection. You can enable this function to automatically detect available updates.

**Username:** Specifies the username of your FTP server.

**Password:** Specifies the password of your FTP server.

**FTP/HTTP URL address:** Specifies the over the air upgrade address (no username or password is required for upgrade over HTTP).

**NOTE:** The FTP address is in the format as below:  
ftp://[IP address of FTP server: port]/Upgrade (the name of the folder containing the over the air upgrade path of the FTP server).

**Save:** You can click this button to save current settings.

**Detect:** After the upgrade file is uploaded and the upgrade path is set, you can click Detect to manually detect the over the air upgrade file. A message pops up when updates are available, as shown in the figure below:

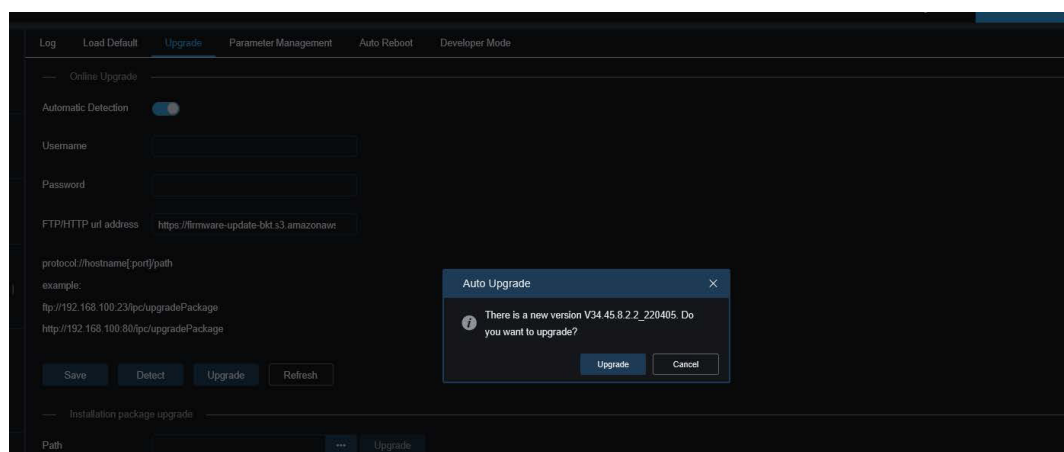

**Upgrade:** Click this button to start system upgrade.

Place the firmware file (.sw) into the HDD of your PC.

Click "..." next to **Path** to select the firmware file from your PC.

Click the **Upgrade** button to start system upgrade. The system upgrade will take about 2 to 3 minutes. Do not power off the device or close your IE browser while system upgrade is in progress.

### 8.11.3.4 - Parameter Management

You can export the configured parameters to your PC or import the exported configuration file from your PC to the device.

EN

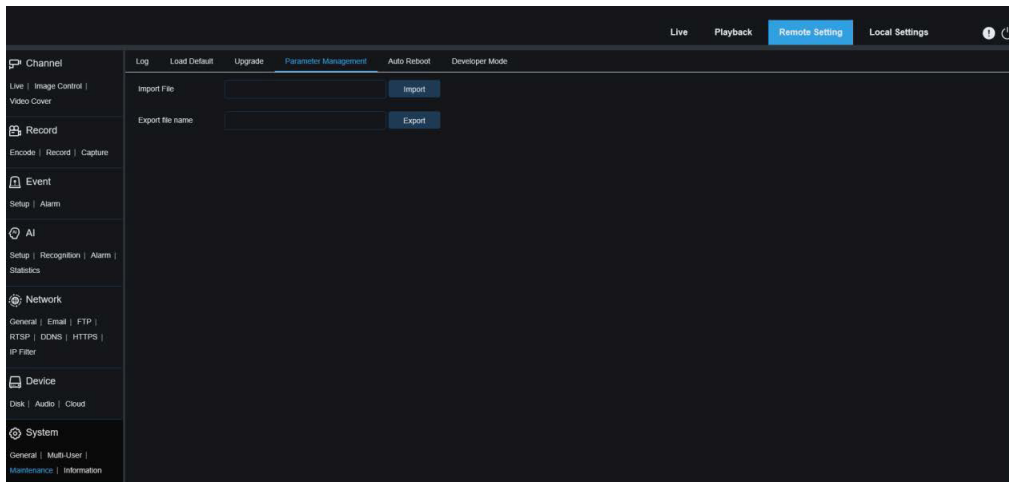

**Import File:** Click the field to display the path window. Select the parameter file and then click **Import** to start importing parameters.

**Export File Name:** Click the field to enter the name of the file to which parameters are exported. Click **Export** to export parameters.

### 8.11.3.5 - Auto Reboot

This menu enables the system to automatically reboot. You are advised to enable this function to guarantee the stable operation of the device.

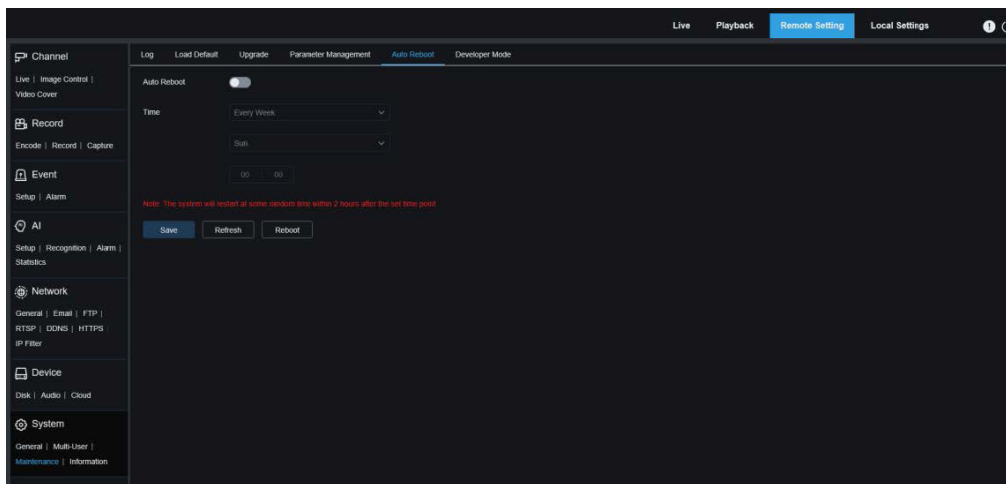

**Auto Reboot:** Used to turn on or off

**Time:** You can set IPC to reboot by day, week, or month.



### 8.11.3.6 - Developer Mode

You can export P2P information of the IPC to your PC.

EN

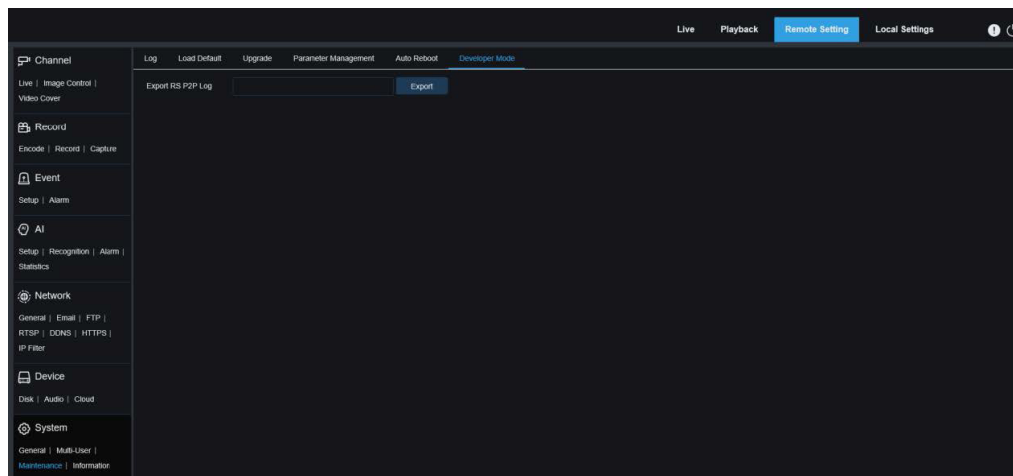

**Export RS P2P Log:** Click the field to enter the name of the file to which parameters are exported. Click **Export** to export parameters.

## 8.11.4 - System Information

This menu allows you to view system information, such as device ID, device model, MAC address, firmware version, and so on.

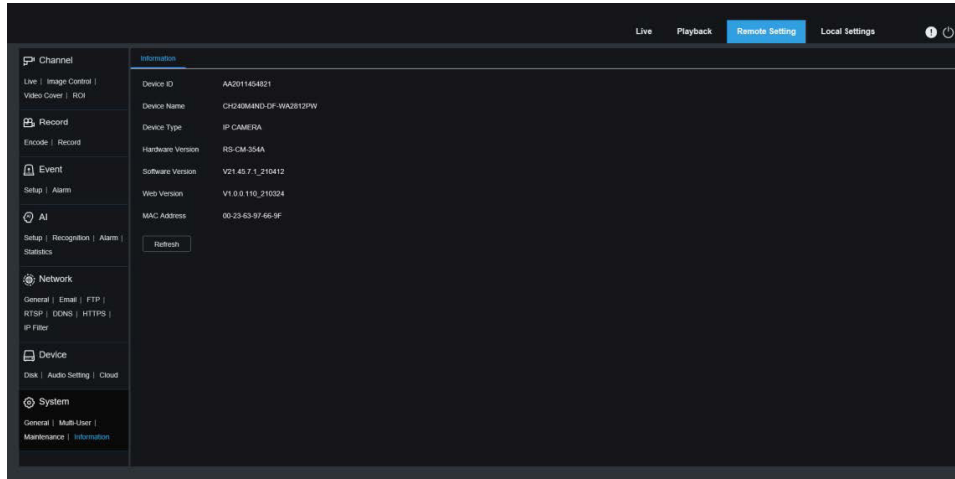

## 9 - LOCAL SETTINGS

This menu allows you to set the path for storing videos and downloaded and captured image files, as well as the format of videos and captured images.

EN

**i** **NOTE:** You can skip this page when you access the web client from Safari 12 and later, Chrome 57 and later, Firefox 52 and later, and Edge 41.

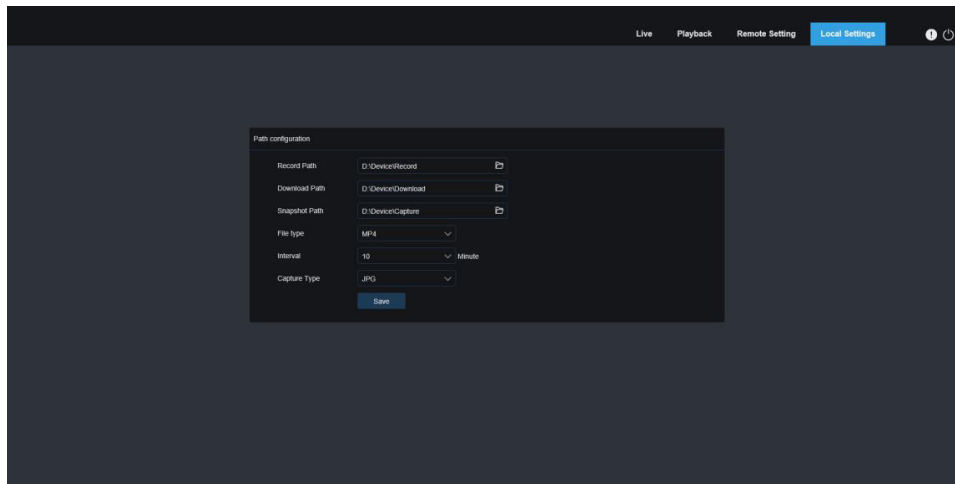

## 10 - APPENDIX

### 6.1 - LIVE

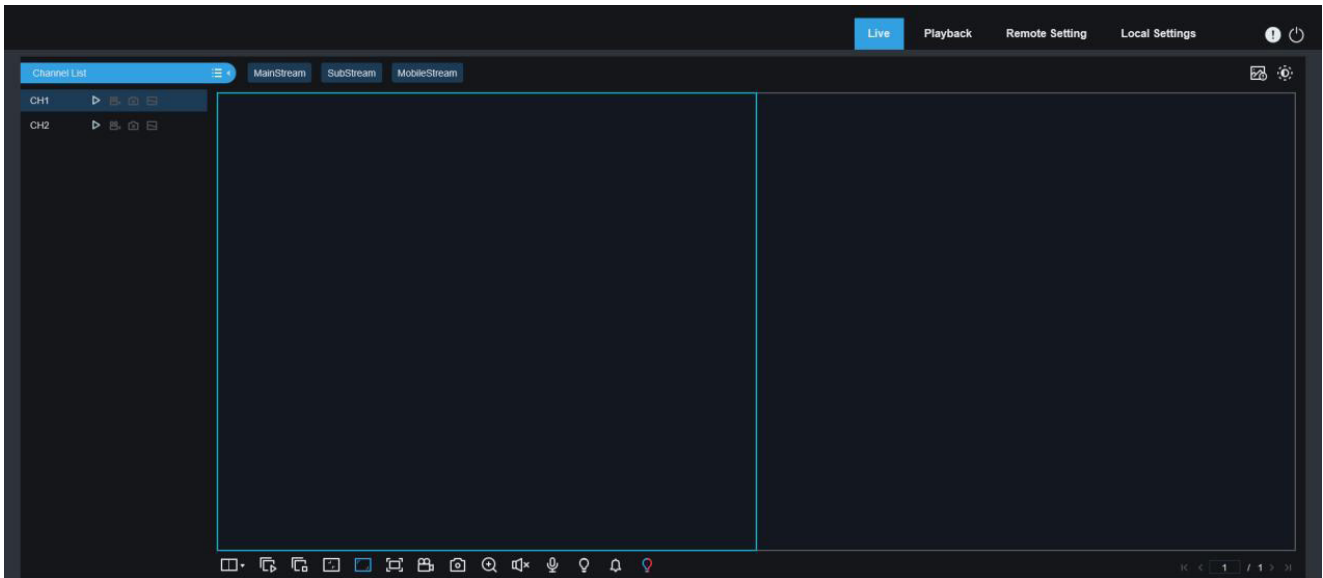

**Channel List:** The left-hand channel list can be hidden or expanded. The two channels of the device are displayed here. CH1 is the optical channel and CH2 is the thermal channel.

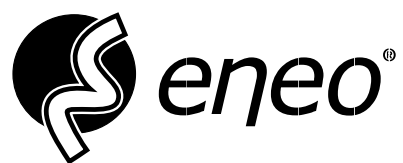

eneo® is a registered trademark of  
VIDEOR E. Hartig GmbH  
Exclusive distribution through specialised  
trade channels only.

VIDEOR E. Hartig GmbH  
Carl-Zeiss-Straße 8  
63322 Rödermark / Germany  
Tel. +49 (0) 6074 / 888-0  
Fax +49 (0) 6074 / 888-100  
[www.videor.com](http://www.videor.com)  
[www.eneo-security.com](http://www.eneo-security.com)

Technical changes reserved

© Copyright by VIDEOR E. Hartig GmbH