

Full User Manual

Network Video Recorder

**PoE, H.265, HDMI, VGA,
SATA, w/o HDD**

**INR-18N040005A
INR-28N080005A
INR-18N320005A**



Learn more about **eneo IN series**
on our YouTube channel.

TABLE OF CONTENT

- ABOUT THIS DOCUMENT 5**
- SAFETY INSTRUCTIONS 6**
- OPEN SOURCE SOFTWARE LICENSE INFORMATION..... 8**
- 1 - PRODUCT OVERVIEW 10**
 - 1.1 - Rear Panel 10
 - 1.2 - Remote Controller 11
- 2 - INSTALLATION & CONNECTION 12**
 - 2.1 - HDD Installation 12
 - 2.2 - Connection Diagram..... 13
 - 2.3 - Power Supply Connection 13
- 3 - COMMON OPERATIONS 14**
 - 3.1 - Using the supplied mouse..... 14
 - 3.2 - Using virtual keyboard..... 14
 - 3.3 - Password 15
 - 3.3.1 - Password Generation15
 - 3.3.2 - Password Reset.....16
- 4 - NVR STARTING UP..... 18**
 - 4.1 - Start Wizard 18
 - 4.1.1 - Network Configuration.....18
 - 4.1.2 - Date/Time.....20
 - 4.1.3 - IP Camera.....21
 - 4.1.4 - Disk.....24
 - 4.1.5 - Resolution.....24
 - 4.1.6 - Mobile25
 - 4.1.7 - Summary.....25
 - 4.2 - Live View Screen Overview..... 26
 - 4.2.1 - Definitions of On screen Icons & Messages.....27
 - 4.2.2 - Camera Quick Toolbar27
 - 4.2.3 - Taskbar28
 - 4.2.4 - Status Bar.....28
 - 4.2.5 - Start Menu29
 - 4.2.6 - Fisheye Camera.....30
 - 4.2.7 - Alarm Notification Panel31
- 5 - SYSTEM SETUP 32**
 - 5.1 - Channel 32
 - 5.1.1 - Channel33
 - 5.1.2 - Live40
 - 5.1.3 - Image Control42
 - 5.1.4 - PTZ45
 - 5.1.5 - Pricavy Zone53
 - 5.1.6 - Motion Detection54
 - 5.1.7 - PIR.....57
 - 5.1.8 - ROI.....60
 - 5.2 - Record..... 61
 - 5.2.1 - Encoding Settings61
 - 5.2.2 - Record63
 - 5.2.3 - Capture Images65
 - 5.3 - Alarm Settings 67
 - 5.3.1 - Motion Alarm67
 - 5.3.2 - PIR Alarm.....69
 - 5.3.3 - I/O Alarm.....71

5.3.4 - Combined Alarm.....	73
5.3.5 - PTZ Linkage	74
5.3.6 - Exception Alarm	75
5.3.7 - Alarm Schedule	76
5.3.8 - Voice Prompts	77
5.3.9 - Deterrence.....	80
5.3.10 - Siren	82
5.3.11 - Disarming.....	83
5.4 - AI.....	84
5.4.1 - AI Setup	84
5.4.2 - AI Recognition.....	102
5.4.3 - AI Alarm Settings	118
5.4.4 - Statistics	126
5.5 - Network.....	129
5.5.1 - General Settings.....	129
5.5.2 - DDNS	134
5.5.3 - Email Settings.....	134
5.5.4 - IP Filter	136
5.5.5 - Voice Assistant	137
5.5.6 - Platform Access	145
5.6 - Device	147
5.6.1 - HDD	147
5.6.2 - Cloud Storage	150
5.6.3 - FTP Settings	153
5.7 - System Configuration.....	155
5.7.1 - General Settings.....	155
5.7.2 - Users	159
5.7.3 - Maintenance.....	162
5.7.4 - IP Camera Maintain	166
5.7.5 - System Information.....	168
6 - AI SCENARIO.....	170
6.1 - Cross Counting.....	170
6.1.1 - Real-Time Display & Controls.....	171
6.1.2 - Settings of Channel View Mode	173
6.1.3 - Settings of Group View Mode	174
6.1.4 - Advertise Mode	175
6.1.5 - Search Counting Data	175
6.2 - Face Attendance	176
6.3 - Object Classification	178
7 - SEARCH, PLAYBACK / BACKUP	179
7.1 - Search & Play in General	179
7.1.1 - Video Segment Backup.....	181
7.2 - Search, Play and Back Up Event Recordins.....	182
7.2.1 - Event Playback Control	183
7.3 - Sub periods Playback	184
7.4 - Smart Search & Playback	186
7.5 - Tag Search & Playback	188
7.6 - Play External File	189
7.7 - Search & Video Snapshots	190
7.7.1 - Playing Slideshow.....	191
7.8 - Slice Search.....	192
7.9 - AI Search	193
7.9.1 - Face Detection Events.....	193
7.9.2 - Search License Plate	198
7.9.3 - Human & Vehicle.....	200
7.9.4 - PID & LCD.....	201
7.9.5 - Repeat Visitors.....	202
7.9.6 - Face Attendance.....	204
7.10 - Exported Video File.....	205

8 - REMOTE ACCESS THROUGH THE WEB CLIENT	206
8.1 - Basic System Environment Requirements.....	206
8.2 - Web Plug in Downloading and Installation.....	206
8.3 - Web Client Management	208
8.3.1 - Live View Page	208
8.3.2 - Playback Page	213
8.3.3 - Remote Setting.....	217
8.3.4 - Local Setting	217
9 - BACKUP VIDEO PLAYING	218
10 - REMOTE ACCESS THROUGH MOBILE DEVICES.....	221
11 - APPENDIX	223
11.1 - FAQ.....	223
11.2 - Use and Maintenance.....	225

ABOUT THIS DOCUMENT

In this document you will find a comprehensive description of a specific series of devices, which we have prepared with great care and accuracy in order to provide you with a deep insight into the general functions and features that characterize this series of devices.

EN

However, you should be aware that the detailed characterization presented in this document is based on the general product line. The individual feature set of specific models or designs within this series may vary depending on their configuration.

The variations may be reflected in an expanded or limited scope of functions and features, thus the actual specifications of individual products may differ in some respects from the designs set forth in this document.

For this reason, we strongly recommend that you thoroughly consult the specific data sheet for the product in question. The data sheet contains specific, detailed information tailored to the particular model. It is the primary reference document that provides the most authentic and accurate information on the individual functionality and features of each specific product in our device series.

We thank you for your understanding and willingness to invest time in acquiring accurate knowledge about the specific product you have selected from our device series. Please do not hesitate to contact us should you have any further questions or require additional information.

SAFETY INSTRUCTIONS

Read the safety instructions and the operating instructions carefully before installing the product.

Depending on the product type, individual points may be omitted.

Mounting & Installation

- Ensure that the intended mounting location is suitable for the respective product (e.g. in terms of weight).
- Securely fasten the products to the locations and surfaces recommended by the manufacturer to ensure stability and safety.
- Ensure that the products are weatherproof when installed outdoors, e.g. protect cameras from direct sunlight or extreme temperatures.
- Make sure that any ventilation slots are not blocked to ensure sufficient air circulation and cooling.
- Make sure that cameras, switches, etc. are installed with sufficient safety distance to flammable materials, power sources, running water, etc.
- Assembly, commissioning and maintenance may only be carried out by authorized specialist personnel in compliance with the relevant standards and guidelines.

Power supply & wiring

- To ensure a safe power supply, use only power supplies and cables recommended by the manufacturer.
- Make sure that the cables are properly routed and protected from tampering and damage (e.g. kinking) to avoid power failures or short circuits (e.g. due to moisture ingress).
- Make sure that the cables are not routed through doors, windows or other moving parts to avoid damage and tripping hazards.
- To disconnect the system from the power supply, pull the cable only by the plug and never directly by the cable.
- When shortening flexible connection cables, use wire end ferrules.

Security

- Use strong passwords for all cameras and devices to prevent unauthorized access.
- Keep device firmware up to date to minimize security vulnerabilities.
- Protect (remote) access to the devices using secure methods such as encrypted connections or VPN.

Operation

- The devices may only be operated within the temperature and humidity ranges specified in the data sheet.
- Sufficient ventilation must be provided to prevent overheating. This applies in particular to devices such as recorders and switches that can generate heat.
- Ensure that no sight lines are blocked and that accessories do not obscure areas used by other equipment or people.
- Ensure cameras are oriented to provide a clear view of the desired area without interfering with people's privacy.

EN

Cleaning & Maintenance

- Clean the lenses and housings of the cameras regularly to ensure a clear view.
- Keep the ventilation slots clean and free of dust to ensure efficient cooling.
- Use a mild detergent for cleaning. Harsh cleaning agents such as thinner or benzine may permanently damage the surface.
- Check the product regularly for damage and signs of wear.
- Only use original spare parts (e.g. connection cable) or accessories from VIDEOR E. Hartig GmbH.
- Any tampering by unauthorized persons will void the warranty.
- Before opening the housing, disconnect the power supply.

Warning, Privacy & Legal Notices

- Draw the attention of visitors to the fact that they are being recorded by means of clearly visible notices.
- If necessary, point out rules of conduct.
- Ensure that cameras are oriented in such a way that privacy is not violated, e.g., by recording neighbours or public areas.
- Comply with local laws and regulations on video surveillance and data protection (GDPR).

OPEN SOURCE SOFTWARE LICENSE INFORMATION

The software components provided with eneo products may contain copyrighted software that is licensed under various open source software licenses. For detailed information about the contained open source software packages, the used package versions, license information and complete license terms, please refer to...

- the open source information included in your products user interface,
- the product detail pages on the eneo website (www.eneo-security.com),
- the eneo download portal (<https://datacloud.videor.com/s/eneodownloadportal>). In case that previous link is broken, the latest link to the eneo download portal can be found on the respective eneo product page at www.eneo-security.com.
- the download package of your firmware. The complete open source software license information of your product is included in the corresponding software download package that can be found in our download portal.

If you are missing any information, please contact opensource@eneo-security.com, we will of course be happy to provide you with the missing information and will also make the missing information available to the public.

If you want to get access to the open source components (source codes) used in our products, please contact opensource@eneo-security.com.

1 - PRODUCT OVERVIEW

1.1 - Rear Panel

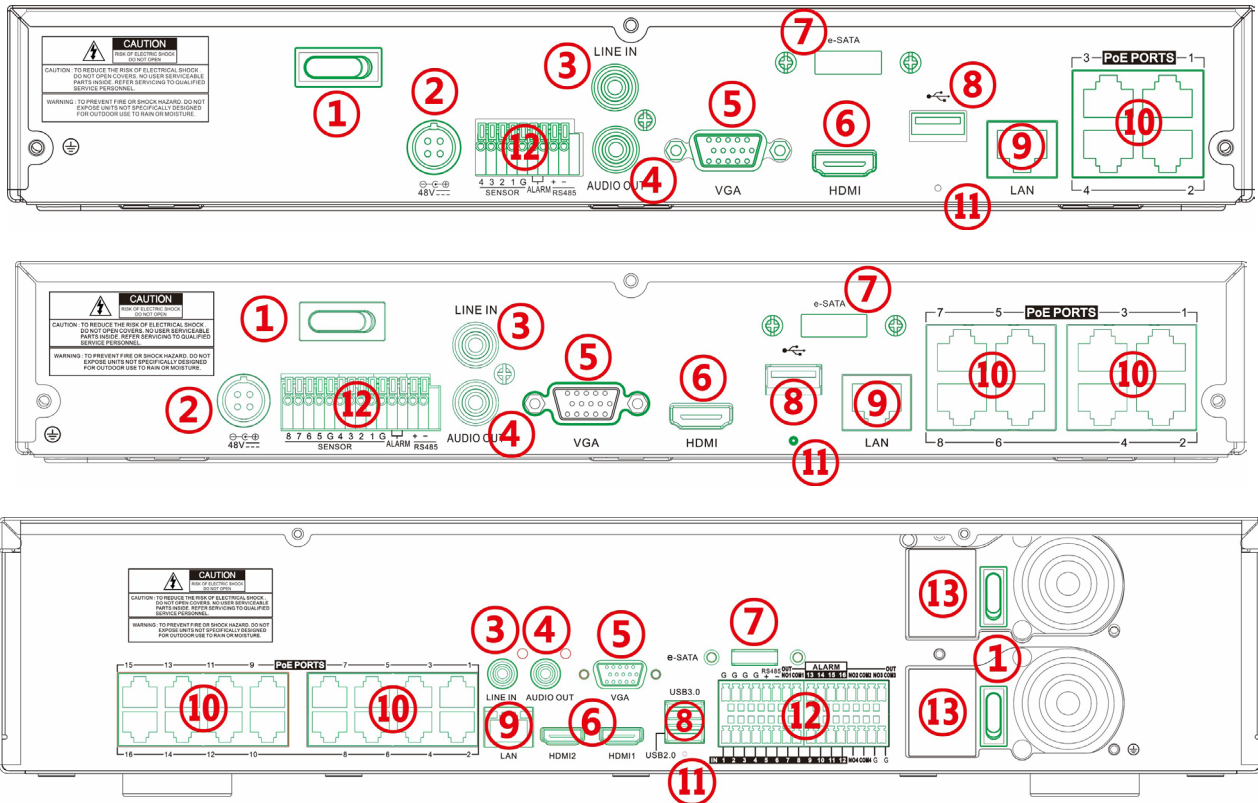

No.	Item	Description
1	Power Switch	To turn on or turn off the power of the NVR
2	DC Power Input	Connect to the attached DC power adapter
3	LINE IN	Audio line input. Connect to audio input device, such as microphone, sound pick-up.
4	AUDIO OUT	Audio output. Connect to audio output device, such as loud speaker.
5	VGA	Connect to a VGA monitor.
6	HDMI	Connect to HDMI display device
7	e-SATA	Connect to an external e-SATA storage device for recording or backup
8	USB	Connect to USB device, such as USB mouse or USB flash drive.
9	LAN Port	RJ45 network interface. Connect to router or network switch.
10	PoE Ports	PoE network ports for IP camera connection. *It is strongly recommended that only 1 camera is connected to an individual PoE port.
11	RESET Button	Press and hold 10 seconds on the button with a small pin to load all settings to default value.
12	Sensor, Alarm & RS485 Terminals	SENSOR & G: connect to external sensors; ALARM: relay output, connect to external alarm device; RS485: Connect to PTZ device, such as speed dome camera
13	AC Power Input	Connect to AC power cord

1.2 - Remote Controller



Button	Functions
0 to 9	Numeric keys; Press number 1 to 9 to display channel 1 to 9 directly. Press combination of numbers quickly to display the channel larger than 9.
ALL	Press to switch the channel display layout among multiple display modes
MENU	Press to display the Task Bar while in live view; Exit and back to previous page while in system menu.
MUTE	Mute or activate the audio output volume
SUBMENU	First press to display the Taskbar while in live view; Second press to display the Camera Quick Toolbar.
▲▼	Move upward or downward; Turn up or turn down the audio volume
◀▶	Move left or right; Decrease or increase the parameter value in system setting menu
SEL	To confirm the choice or setup
◀◀	Rewind button. Press to play video fast rewind in different speed
▶▶	Forward button. Press to play video fast forward in different speed
▶	Play button; Enter search menu
●	Manual record button
■	Stop manual record or stop the video playback; Press and hold 3 seconds to reset the VGA/HDMI output resolution to default value.
⏸	Press to pause video play

EN

i **NOTE:** Your NVR might be packed without remote controller

2 - INSTALLATION & CONNECTION

2.1 - HDD Installation

Depending on the NVR you have purchased, the hard disk drive (HDD) may be included in the full package. If it is not pre-installed, follow the installation instructions on this user manual.

i CAUTION: Do NOT install or uninstall the HDD while the NVR is powered on

Installation

1. Power off the NVR, remove screws on both sides & rear panel and open the upper cover.

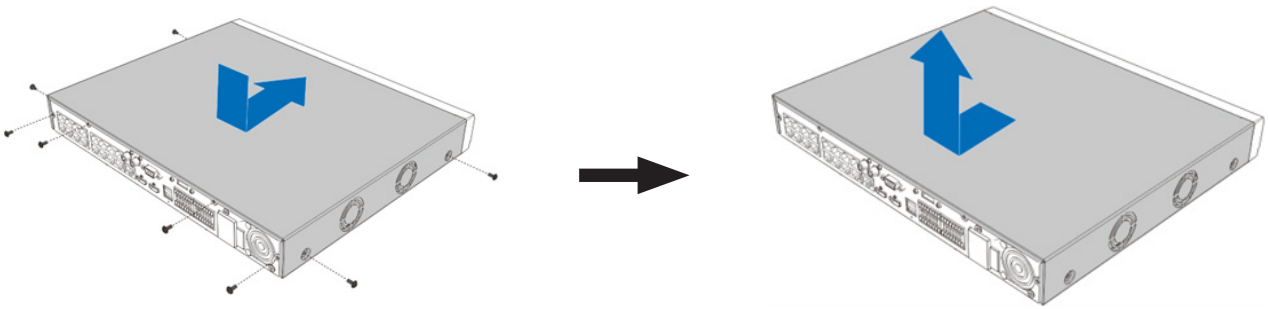

2. Connect the data and power cables to the HDD and place it on the bottom case. Carefully flip the case and secure the HDD to the case with screws.

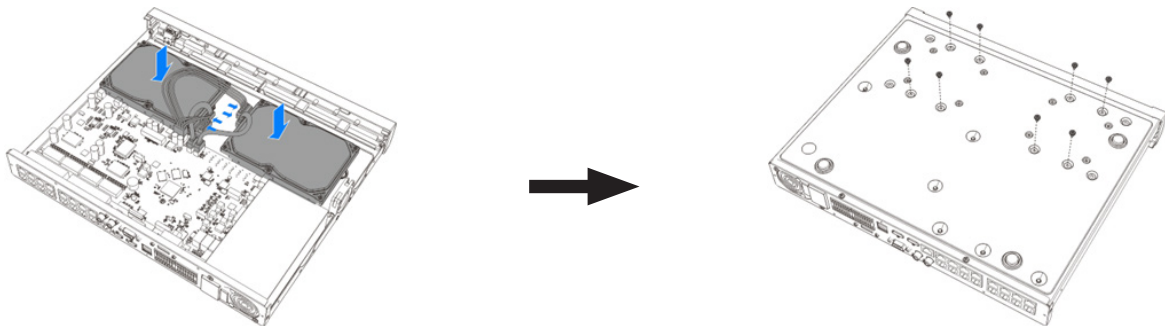

3. Put the upper cover back carefully, and fix the cover with screws.

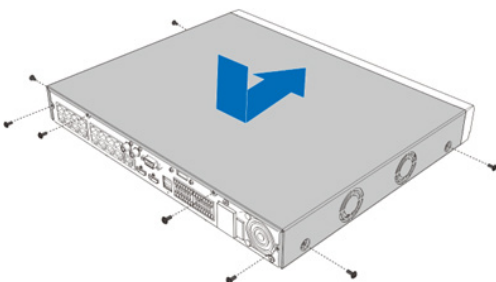

i NOTE: Above procedures are for reference only. The practical operation may vary with models.

2.2 - Connection Diagram

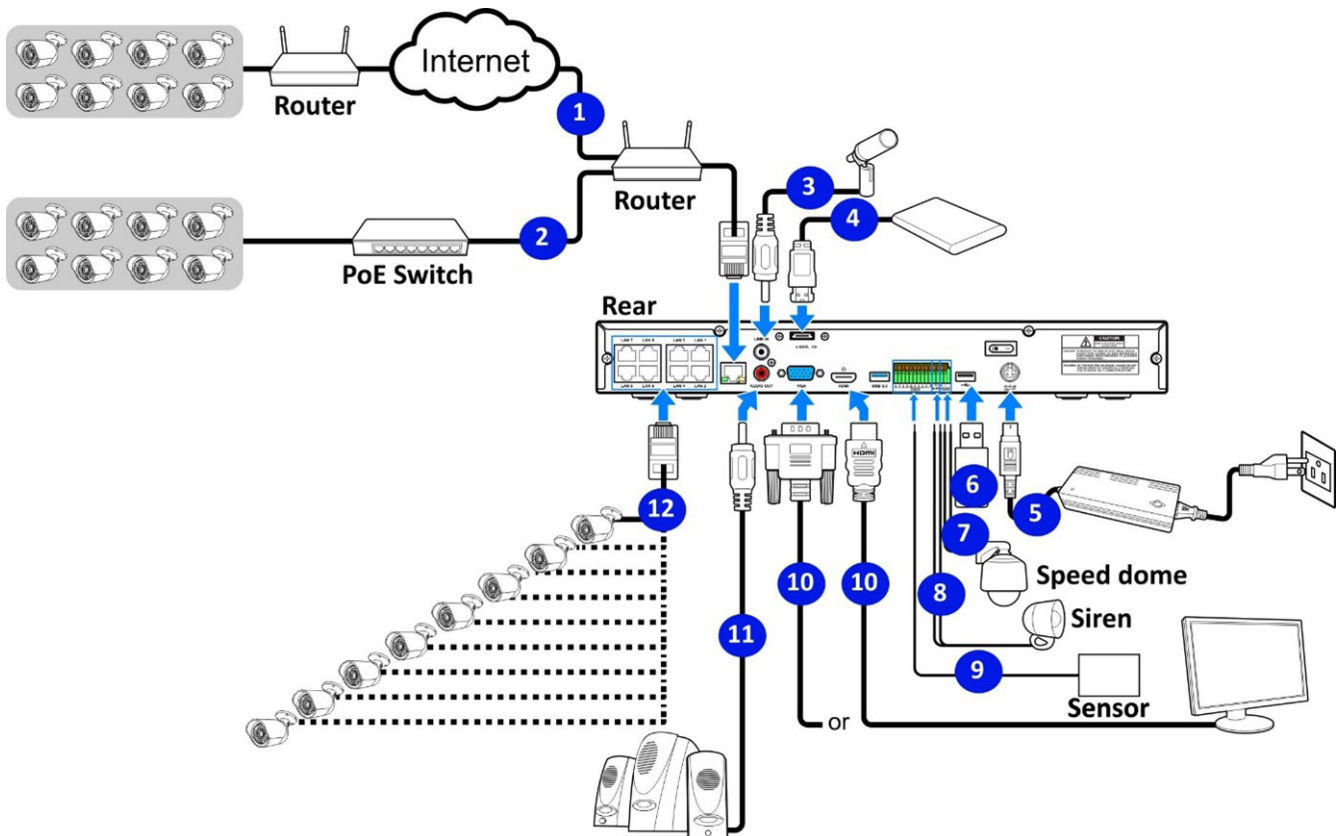

EN

NOTE: Above connection diagram is for illustration purpose only. The interfaces in your actual product may vary with models.

2.3 - Power Supply Connection

CAUTION: Use the power supply attached or specified by the manufacturer only. Contact your local dealer if any problem with the power supply is found.

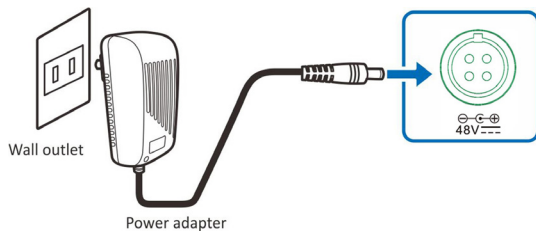

You may need to press the power switch to turn on the NVR if there is a power switch on the rear panel of your NVR.

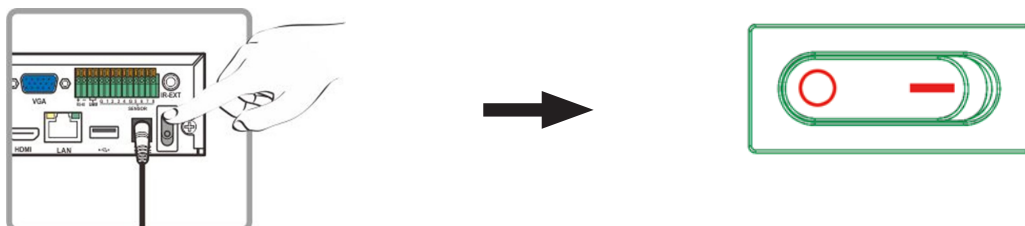

NOTE: Above pictures are for illustration purpose only. The interfaces in your actual product may vary with models.

3 - COMMON OPERATIONS

3.1 - Using the supplied mouse

A - Left Button

- Click to select menu options.
- During live viewing in split-screen view, double-click on a channel to view it in full-screen. Double-click the channel again to return to split-screen viewing.
- Click upon a channel on Live Viewing screen to open Camera Quick Toolbar.
- Click and hold to drag sliders and scales on menu mode

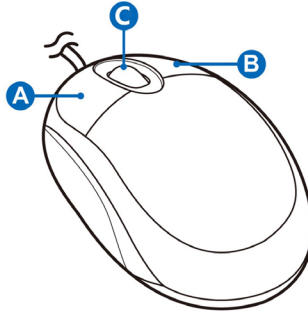

B - Right Button

- Click once to open the Taskbar on the Live Viewing screen. View Taskbar on 4.2.2 Taskbar.
- In menus, click to go back / close menus.

C - Scroll Wheel

- In menus, scroll to move up / down through the menu content.
- While hovering over the volume control wheel, scroll to turn system volume up / down.

3.2 - Using virtual keyboard

You will see the virtual keyboard automatically on the screen when you need to enter data, such as enter password, camera title, etc.



- 1 – Click to toggle the keyboard to upper case and more punctuations
- 2 – Move the cursor to left
- 3 – Move the cursor to right
- 4 – Click to delete a character
- 5 – Click to finish

3.3 - Password

Proper configuration of all passwords & other security settings is the responsibility of the installer and/or end-user.

EN

3.3.1 - Password Generation

For the first time when you run the NVR, you must be required to set your own password immediately in order to protect your privacy. Please be sure to record your username and password and save them in a secure place.

Language: Choose an available OSD language

Device ID: Input the device ID in the parentheses. Default ID is 000000. View more about Device ID on 5.7.1. General.

New Admin Password: To set your own password. The password must be a combination of 8 to 16 characters, which is combined with at least 2 kinds of different characters from uppercase letters, lowercase letters, digit numbers and special symbols.

Confirm Password: Enter the password again.

Unlock Pattern: Select **Enable** to draw your pattern lock.

Click **Apply** to confirm your settings. The system will require to set the password recovery questions in case you forget the password.

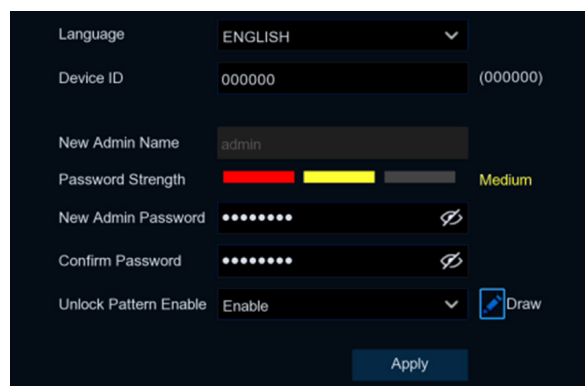
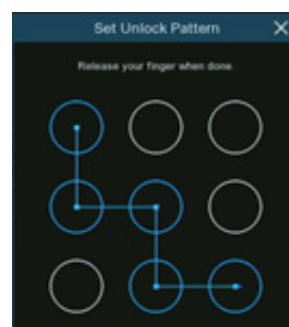
Tick the box of **Security Question Configuration**, and then choose 3 questions and input your answer to each question.

If you tick the box of **Certificate of Authorization**, you need to click the **Export** button to save a secret key to your USB flash drive. It will help to reset the password with the secret key in future.

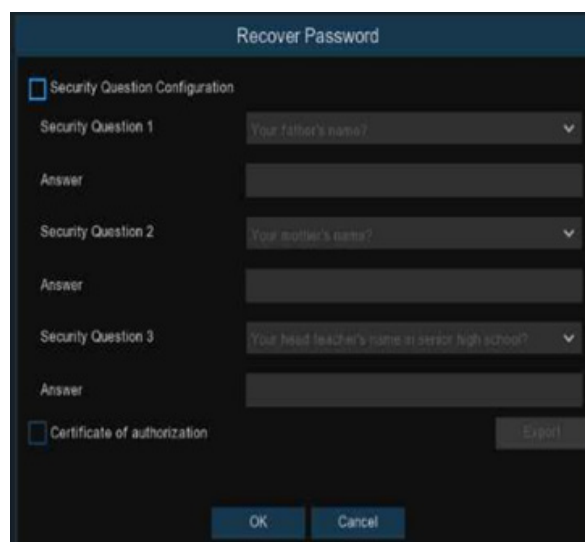

3.3.2 - Password Reset

If you forget your password, you will be unable to login the system, reset your password with below methods:

3.3.2.1 - Reset with password recovery questions

If you had enabled the password recovery questions in 3.3.1. Password Generation, you are able to reset your password with security questions.

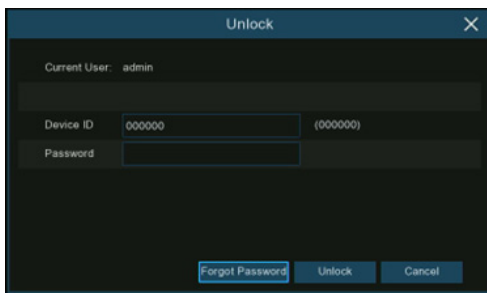

1. Click the **Forgot Password** button on the login window.

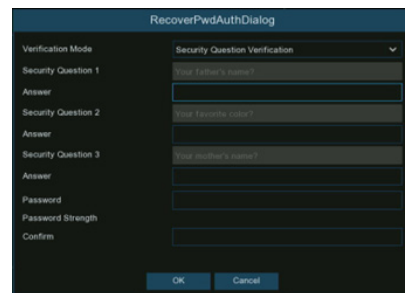

2. Choose **Security Question Verification**. Input the answer to each question and then input new password. Click **OK** to activate the new password.

3.3.2.1 - Reset with secret key

If you had exported the secret key in 3.3.1. Password Generation, you are able to reset your password with secret key.

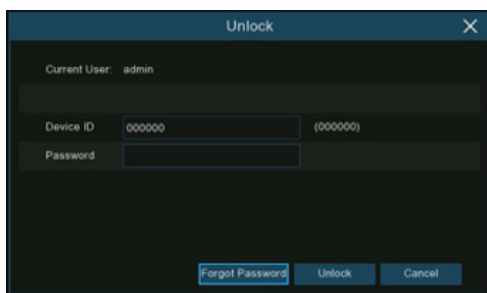

1. Click the **Forgot Password** button on the login window.

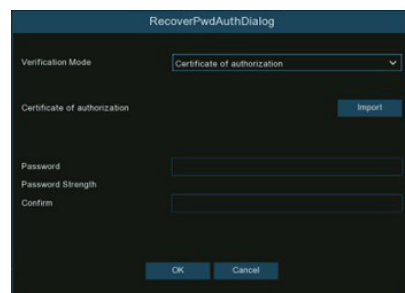

2. Choose **Certificate of Authorization**. Click **Import** button to load the secret key from your USB flash drive, and then input new password. Click **OK** to activate the new password.

3.3.2.3 - Hard Reset

If you are unable to reset the password with any one of the methods of A, B and C, you can try to hard reset your NVR if there is a Reset button on the rear panel.

EN

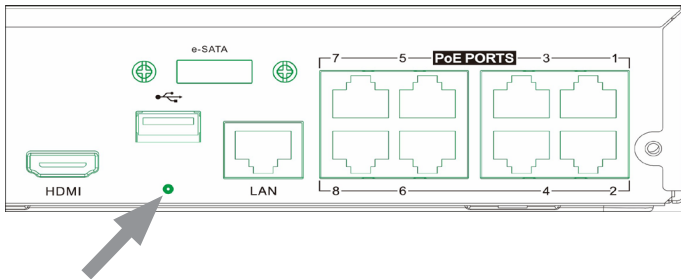

Press and hold 10 seconds on the button with a small pin till the NVR beeps.

i NOTE: The hard reset will not only reset the password but will also load all system settings to default value. Your self-defined settings will be lost.

4 - NVR STARTING UP

4.1 - Start Wizard

For the first time when you run this NVR, you may need to configure the Startup Wizard which will help to configure the system and get your NVR works properly and quickly.

Log in the system and click the **Start Wizard** to proceed to the next step.

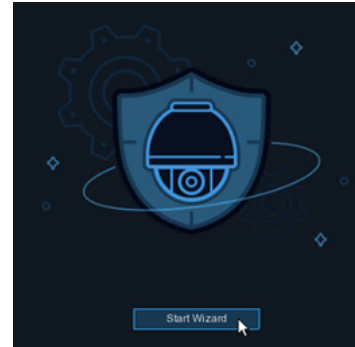

4.1.1 - Network Configuration

If you connect to a router allows to use DHCP, please tick the **DHCP** box. The router will assign automatically all the network parameters for your NVR. Unless the network is manually addressed below parameters:

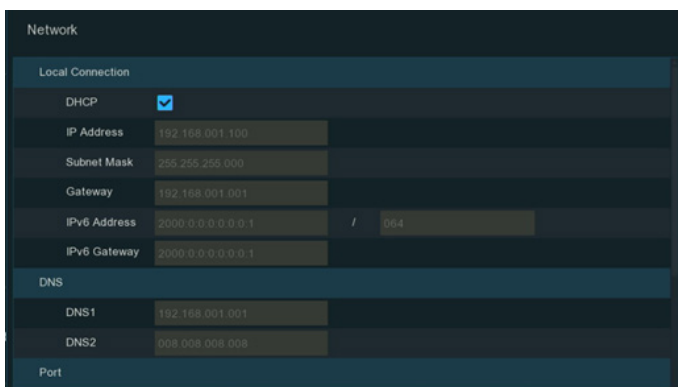

Network	
Local Connection	
DHCP	<input checked="" type="checkbox"/>
IP Address	192.168.001.100
Subnet Mask	255.255.255.000
Gateway	192.168.001.001
IPv6 Address	2000:0:0:0:0:0:0:1 / 64
IPv6 Gateway	2000:0:0:0:0:0:0:1
DNS	
DNS1	192.168.001.001
DNS2	008.008.008.008
Port	

IP Address: The IP address identifies the NVR in the network. It consists of four groups of numbers between 0 to 255, separated by periods. For example, "192.168.001.100".

Subnet Mask: Subnet mask is a network parameter which defines a range of IP addresses that can be used in a network. If IP address is like a street where you live then subnet mask is like a neighborhood. The subnet address also consists of four groups of numbers, separated by periods. For example, "255.255.000.000".

Gateway: This address allows the NVR to access the Internet. The format of the Gateway address is the same as the IP Address. For example, "192.168.001.001".

IPv6 Address: Input the IPv6 address you got from your ISP.

DNS1/DNS2: DNS1 is the primary DNS server and DNS2 is a backup DNS server. Usually, it should be enough just to enter the DNS1 server address.

Port

EN

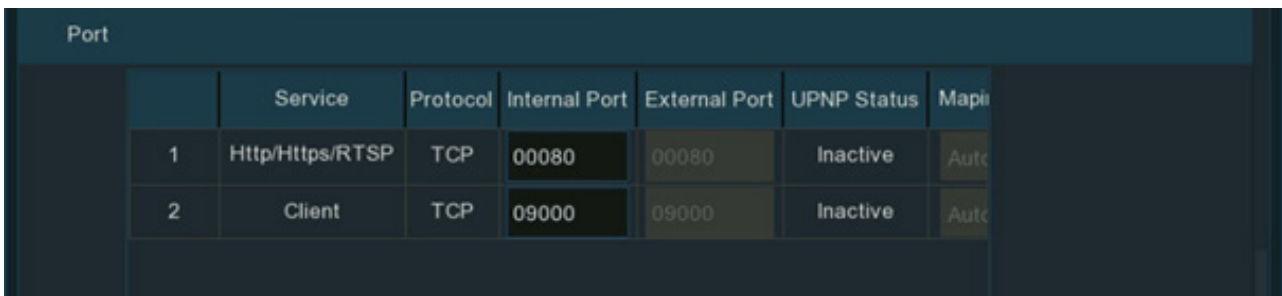

	Service	Protocol	Internal Port	External Port	UPNP Status	Mapping Strategy
1	Http/Https/RTSP	TCP	00080	00080	Inactive	Auto
2	Client	TCP	09000	09000	Inactive	Auto

http/https/rtsp: This is the port that you will use to log in remotely to the NVR (e.g. using the Web Client), or the NVR will be allowed to transmit real-time streaming to other device (e.g. using a streaming Media player.). The ONVIF is using the same port also.

If the default port 80 is already taken by another application, please change it.

Client: This is the port that the NVR will use to send information through (e.g. using the mobile app). If the default port 9000 is already taken by other applications, please change it.

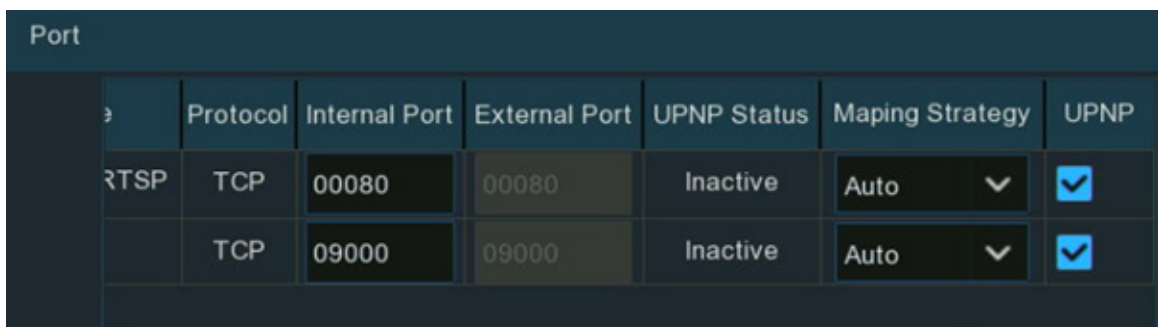

	Protocol	Internal Port	External Port	UPNP Status	Mapping Strategy	UPNP
RTSP	TCP	00080	00080	Inactive	Auto	<input checked="" type="checkbox"/>
	TCP	09000	09000	Inactive	Auto	<input checked="" type="checkbox"/>

Internal Port: Mainly used for LAN connection.

External Port: Mainly used for WAN / Internet connection.

UPNP: If you want to log in remotely to the NVR using Web Client via different router/LAN, you need to complete the port forwarding in your router. Enable this option if your router supports the UPnP. In this case, you do not need to configure manually port forwarding on your router. If your router does not support UPnP, make sure the port forwarding is completed manually in your router.

Mapping Strategy: If you want the port randomly distributed by the router UPnP server, choose **Auto**; If you want to manually forwarded the port, choose **Manual**.

PPPoE: This is a protocol that allows the NVR to connect to the network directly via a DSL modem.

Tick the **Enable PPPoE** box, and then enter the User name & Password of the PPPoE which is provided by your ISP.

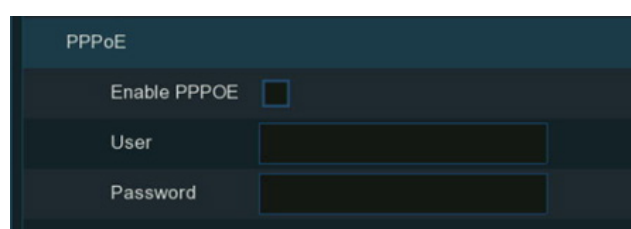

PPPoE

Enable PPPOE

User

Password

4.1.2 - Date/Time

This menu allows you to configure the Date, Time, Date Format, Time Format, Time Zone, NTP and DST.

Date/Time

Click on the calendar icon to set the current system date.

Date: Click on the calendar icon to set the system date.

Time: Edit the system time.

Date Format: Choose from the dropdown menu to set preferred date format.

Time Format: Choose time format between 24Hour and 12Hour.

Time Zone: Choose your time zone.





Date and Time	NTP	DST
Date		04/15/2021 
Time		11:28:21
Date Format		MM/DD/YYYY 
Time Format		24Hour 
Time Zone		GMT+08:00 

NTP

NTP stands for Network Time Protocol. This feature allows you to synchronize the date and time automatically on the NVR over Internet. Therefore, the NVR needs to be connected to the Internet.

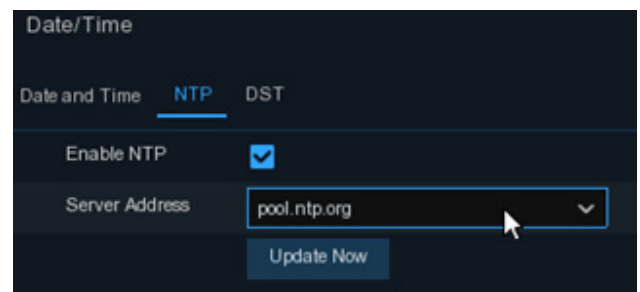
Tick the "NTP" box, and select the NTP server.



Date and Time	NTP	DST
Enable NTP	<input checked="" type="checkbox"/>	
Server Address	pool.ntp.org 	
Update Now		

DST

DST stands for Daylight Savings Time.







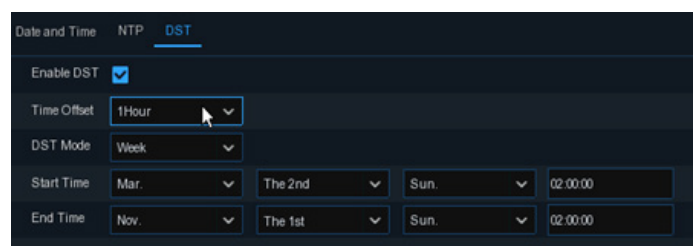

Enable DST: Tick to enable if Daylight Saving Time (DST) is observed in your region

Time Offset: Select the amount of time to offset for DST

DST Mode: Choose to set the daylight-saving time in weeks or in days

Start Time/End Time: Set the start time and end time for daylight saving



Date and Time	NTP	DST
Enable DST	<input checked="" type="checkbox"/>	
Time Offset	1Hour 	
DST Mode	Week 	
Start Time	Mar. 	The 2nd 
	Sun. 	02:00:00
End Time	Nov. 	The 1st 
	Sun. 	02:00:00

4.1.3 - IP Camera

Add IP cameras to the NVR in this section.

EN

4.1.3.1 - Connect IP Camera to NVR PoE Ports

IP cameras will get online automatically if the IP cameras are connected to the PoE ports on the rear panel. The online cameras will be displayed on the right side of the window.

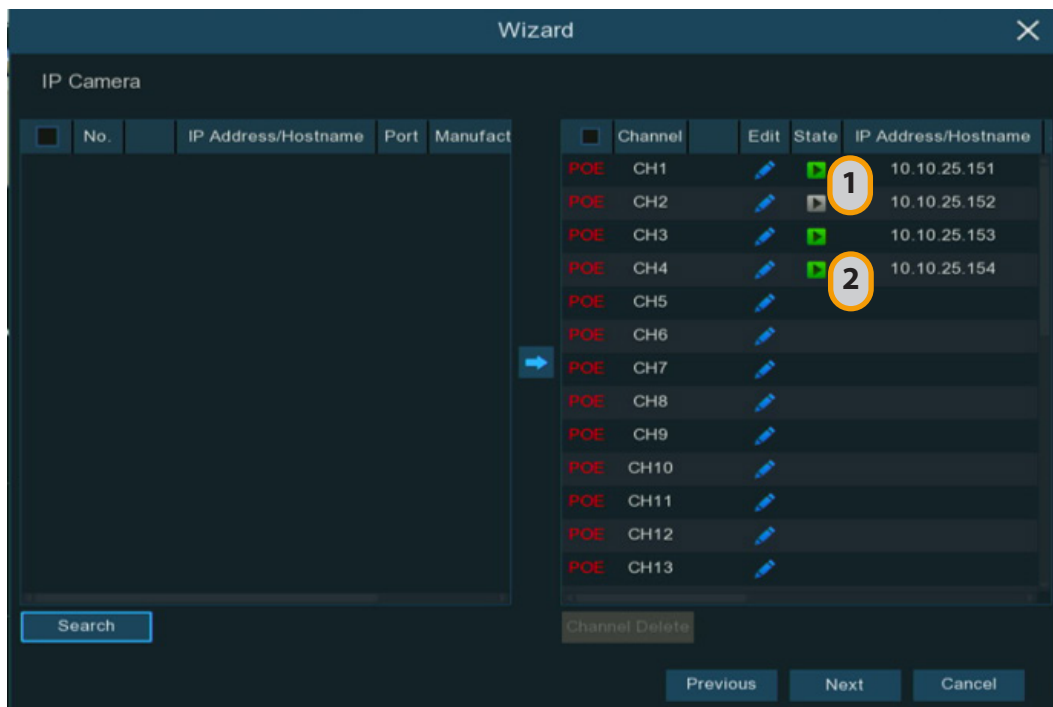

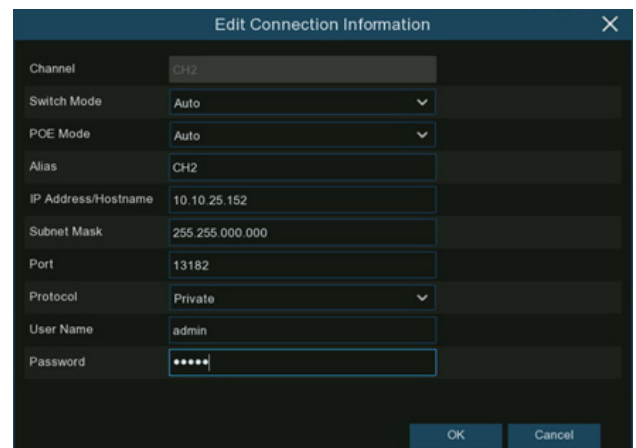
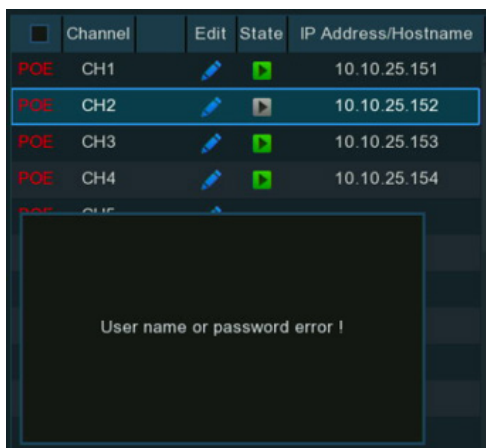

- 1 – If the camera is failed to connected, the state will be displayed with a grey icon.
- 2 – If the camera is successfully connected, the state will be displayed with a green icon.

Click on the grey icon, a message will be pop-up to tell the failure reason. If it shows “User name or password error!”, click the edit icon, and then input the correct user name and password of the camera.



4.1.3.2 - Add IP Camera to PoE NVR from LAN

If you want to add an IP camera to the PoE NVR from LAN, please make sure your NVR is well-connected to the LAN, and the IP camera you want to add is in the same network segment with your NVR.

1. Click the edit icon  in the channel you want to add, and then click the drop-down arrow next to Switch Mode to select **Manual** and click **OK** to save.
2. Click the **Search** button on the left bottom corner of the window, all available cameras in the LAN will be displayed. Select the camera you want to add, then click the add icon  . Or click the Add icon  in the channel list and then click **Search** button, all available cameras in the LAN will be displayed. Click on the camera you want to add.
3. Input the user name and password of the camera, and then click **Add** button to complete.

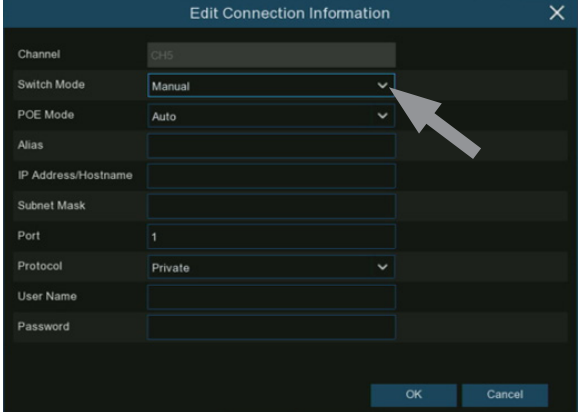

Channel: CH5

Switch Mode: Manual

POE Mode: Auto

Alias:

IP Address/Hostname:

Subnet Mask:

Port: 1

Protocol: Private

User Name:

Password:

OK Cancel

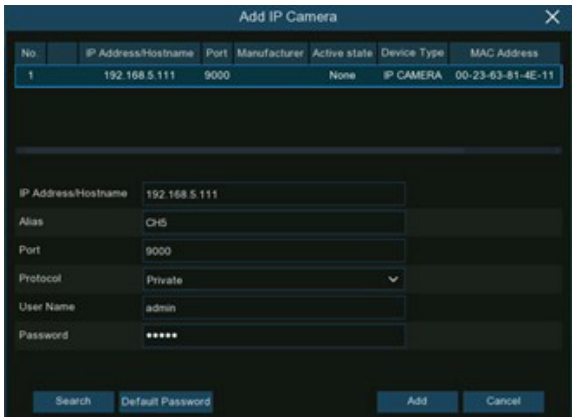

No.	IP Address/Hostname	Port	Manufacturer	Active state	Device Type	MAC Address
1	192.168.5.111	9000		None	IP CAMERA	00-23-63-81-4E-11

IP Address/Hostname: 192.168.5.111

Alias: CH5

Port: 9000

Protocol: Private

User Name: admin

Password: *****

Search Default Password Add Cancel

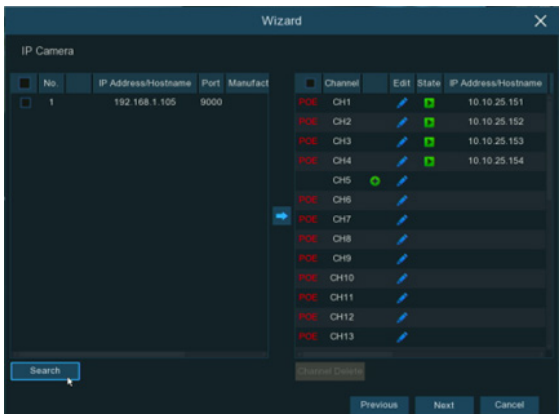

IP Camera

No.	IP Address/Hostname	Port	Manufact	Channel	Edit	State	IP Address/Hostname
1	192.168.1.105	9000		POE CH1			10.10.25.151
				POE CH2			10.10.25.152
				POE CH3			10.10.25.153
				POE CH4			10.10.25.154
				CH5			
				POE CH6			
				POE CH7			
				POE CH8			
				POE CH9			
				POE CH10			
				POE CH11			
				POE CH12			
				POE CH13			

Search

Previous Next Cancel

4.1.3.3 - Add IP Camera to PoE NVR from Internet

If you want to add an IP camera to the PoE NVR from internet, please make sure your NVR is well-connected to internet.

EN

1. Click the edit icon in the channel you want to add, and then click the drop-down arrow next to Switch Mode to select **Manual** and click **OK** to save.
2. Click the Add icon in the channel list.
3. Input the IP camera's internet IP address, port, protocol, user name and password.

Click **Add** button to complete.

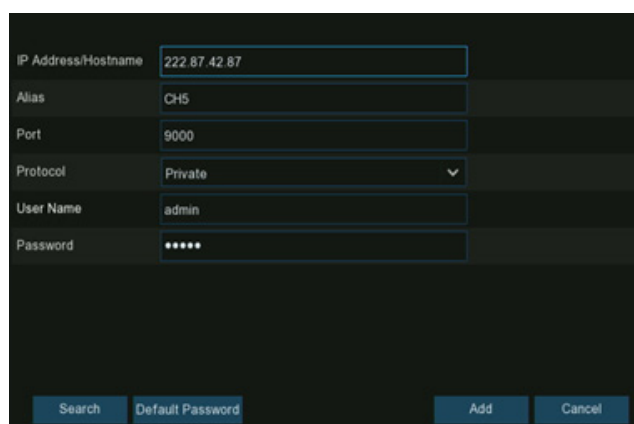
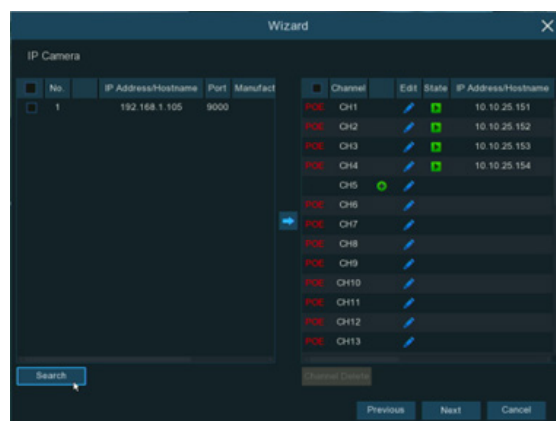
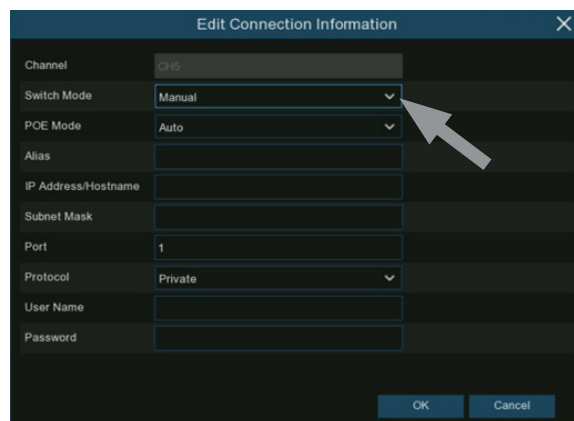

4.1.3.4 - Add IP Camera to Non-PoE NVR

For Non-PoE NVR, you need to add the IP cameras from LAN and/or Internet manually.

Please refer to 4.1.3.2. Add IP Camera to PoE NVR from LAN & 4.1.3.3. Add IP Camera to PoE NVR from Internet.

4.1.4 - Disk

HDD must be formatted If it is installed in the NVR for the first time.

Select the HDD and then click **Format HDD** button to format the HDD.

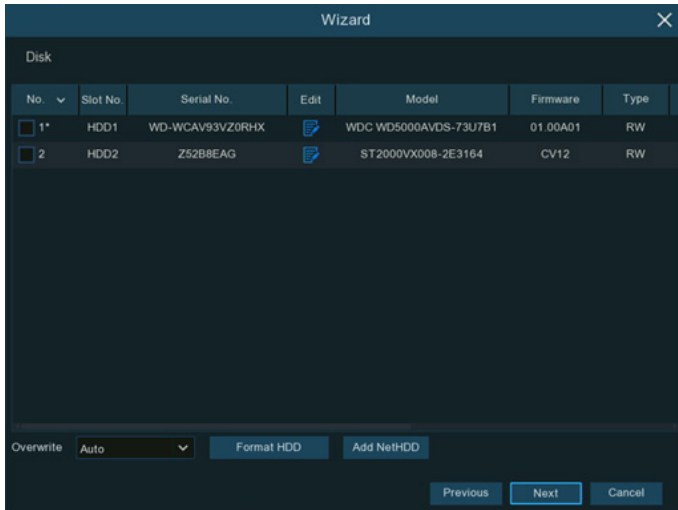

Overwrite: This instructs your NVR to overwrite the oldest video files as the hard drive becomes full. You also have the option of selecting the amount of days for recordings to be kept before they are overwritten. For example, if you choose the option 7 days then only the last 7 days' recordings are kept on the HDD.

To prevent overwriting any old recordings, select **OFF**. If you have set Off on this feature, please check the HDD status regularly to make sure the HDD is not full. Recording will be stopped if HDD is full. We recommended leaving the **Auto** selection as this prevents your NVR from running out of storage space.

Add NAS HDD: To add your NAS disk.

Record On e-SATA: If your NVR comes with an e-SATA port on the rear panel, you can enable to record the video to e-SATA HDD. This function only available when your e-SATA HDD has been connected to the NVR already.

4.1.5 - Resolution

Choose an output resolution matches to your monitor. The NVR supports to adjust the output resolution automatically to match the best resolution of your monitor when the system is starting up.

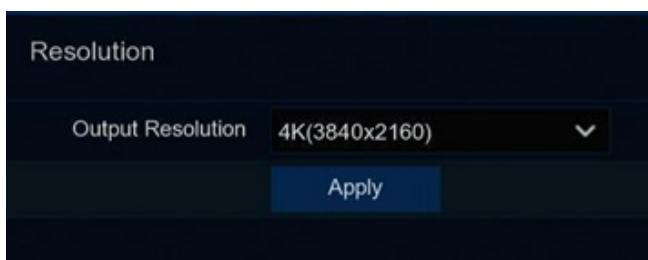

If you connect to a 4K HDMI monitor, you are able to choose max. 4K (3840x2160) resolution.

If you connect a VGA monitor, do not choose the resolution larger than 1080P(1920x1080).

4.1.6 - Mobile

If your NVR come with a P2P ID, you can scan the QR code with your mobile app to view the NVR remotely.

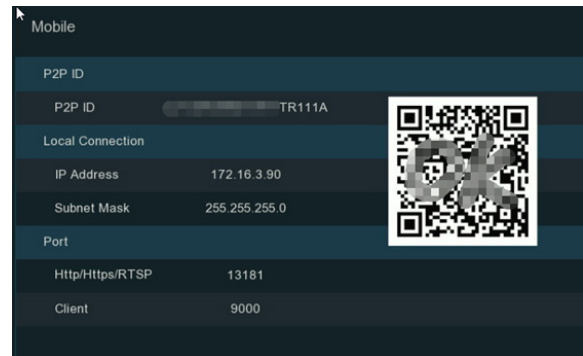

EN

4.1.7 - Summary

You can tick the system summary information you had set in the start wizard and finish the wizard. Tick **“Don’t show the Wizard after start.”** if you don’t want to display the Start Wizard after the system start. Click **Finish** button to save & exit.

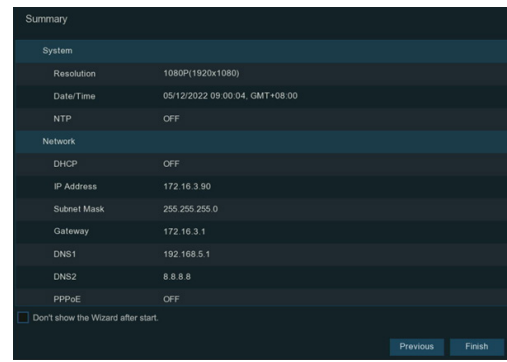

4.2 - Live View Screen Overview

For the first time when you run this NVR, you may need to configure the Startup Wizard which will help to configure the system and get your NVR works properly and quickly.



- 1 – Channel No.
- 2 – Status Icons
- 3 – Camera Quick Toolbar
- 4 – Start Menu
- 5 – Task Bar
- 6 – HDD Error Icon
- 7 – Channel Abnormal Message
- 8 – Status Bar
- 9 – Alarm Notification Panel

4.2.1 - Definitions of On screen Icons & Messages

Status Icons	
Icon	Meaning
	The camera is being recorded currently
	A motion alarm is happening
	An intelligent or Ai alarm is happening
	The external I/O alarm device is being triggered
	The PIR alarm is being triggered

HDD Error Icons	
Icon	Meaning
	HDD is uninstalled or in error
	HDD is unformatted
	HDD is full
	HDD is read-only

Channel Abnormal Message	
Message	Meaning
No Camera	No camera is added to this channel. You can click the add icon to add a new camera.
Failed to connect to camera, please check the network connection!	The added camera is off-lined or lost connection. Please check the camera working status or network connection. You can click the edit icon to check the camera status.
User name or password error!	Incorrect user name or password of the camera. Click the edit icon to modify.
Resource Not Enough	No enough system resource to decode the camera images, please try to change the cameras to sub-stream mode; If there are 2 or more cameras are using MJPEG decoding, only 1 camera can be encoded at the same time.
No enough bandwidth for this camera!	The camera cannot get online because the total bitrate of all connected cameras exceeds the NVR's bandwidth limitation.

EN

4.2.2 - Camera Quick Toolbar

In live viewing, click the left button of your mouse on a connected camera to display the Camera Quick Toolbar.



Icon	Meaning
	Click to manually record the channel immediately. If the manually recording is in process, the icon will be in red color. Click one more time to stop manual record.
	Click to save a snapshot of the current camera image. Manual Capture must be enabled to use this feature. For details on enabling Manual Capture, see 5.2.3.1 Capture.
	Click to play the latest 5 minutes recording of this channel
	Click to enter PTZ control panel; Click to control zoom and focus of motorized varifocal lens
	Click to zoom-in the channel. Scroll the wheel button of your mouse to zoom in and zoom out the image.
	Click to adjust the image color of the channel.
	To switch the live view video stream between HD & SD. HD is mainstream images, SD is substream images.
	Click this button to enter fisheye mode. To use this button, device support is required and a fisheye camera should be connected first.
	Click to start two-way voice communication
	If your camera has white light LEDs, click this button to turn on or turn off the LEDs.
	If your camera has a built-in speaker, click this button to turn on or turn off the alarm sound.
	If your camera has warning light LEDs, click this button to turn on or turn off the LEDs.
	Tag button. It supports to fast search by adding a tag in live view. See more on 7.5 Tag Search.
	AI statistics. Hover the mouse upon the icon to view AI statistics when the AI function is activated in your NVR.

4.2.3 - Taskbar

In the Taskbar, you are able to enter the system menu, start playback and change the live view display, etc.



Icon	Meaning
	Click to pop up the Start Menu
	Click to display 4/9/12/16 channels in live view screen
	Click to display 20/25/36 channels in live view screen
	Click to choose more display layouts in live view screen
	Click to start viewing channels in a sequence. You're able to set the sequence display mode on 5.8.1.4 Output Configuration.
	Quick playback. You can choose to play the recording for all channels from the beginning of the day, or you can choose the play the latest 5 seconds, 10 seconds, 30 seconds, 1 minute or 5 minutes by clicking the triangular button .
	Click to adjust audio output volume
	Click to switch the live view image resolution for all channels between mainstream and substream.
	Click to switch the image scale for all channels between original and stretch.
	Click to switch among real-time, balanced, or smooth view. It affects the live view video quality by changing the bitrate and frame rate.
	Click this button to restore the scrambled channel positions.

4.2.4 - Status Bar

In the Status Bar, you are able to check the network connection status, turn on/off white light LEDs and alarm sound, start and stop manual record, check the system information, disable mouse and system time.







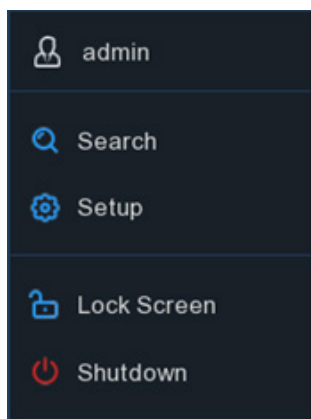

Icon	Meaning
	Network is disconnected.
	Network is connected but offline.
	Network is well connected.
	The device is in arming status.
	The device is in disarming status.
	To turn on or turn off all the white light LEDs and alarm sound for available cameras.
	To operate manual record and manual relay alarm output
	To view system information, channel information, record info and network state.
	The device is connected through USB_ WIFI and is recognized successfully. It can access the Internet through WiFi. For more information, see Section 5.5.1.4.
	Click this button to switch the mouse between the primary screen and the secondary screen. To use this button, device support is required.

4.2.5 - Start Menu

With the Start menu, you can switch user, search & playback, enter system setup menu, lock & unlock the screen, shut down, reboot & logout the system.

EN



Item	Description
 admin	To switch user. To enable multi-user, please view on 5.7.2. Multi-user.
 Search	Search & Playback. View more on Chapter 7. Search, Playback & Backup.
 Setup	NVR System Setup. View more on Chapter 5. System Setup
 Lock	Lock & unlock screen.
 Unlock	
 Shutdown	Shutdown, reboot & logout the system.

Unlock and Lock Screen

The screen will be locked automatically to protect unauthorized OSD operation while the NVR is not in menu operation if you have set a Menu Timeouts in 5.7.1.1 System General Setting.

If necessary, you can also lock the screen operation manually. Go to Start Menu, and then click the Lock Screen icon  to lock the system immediately.

If the system is locked, you can click the Unlock icon  to unlock the system for further operation.

Shutdown

Click the **Shutdown** button from Start Menu, you're able to shut down, reboot or logout the NVR.

Click **OK** button, system will require to input the user password to authenticate.

4.2.6 - Fisheye Camera

After a fisheye camera is added to the device and the device goes online, the fisheye operation icon is displayed in the shortcut menu of the preview channel area and the playback menu.

You can click the  button to open the fisheye-mode operation page.

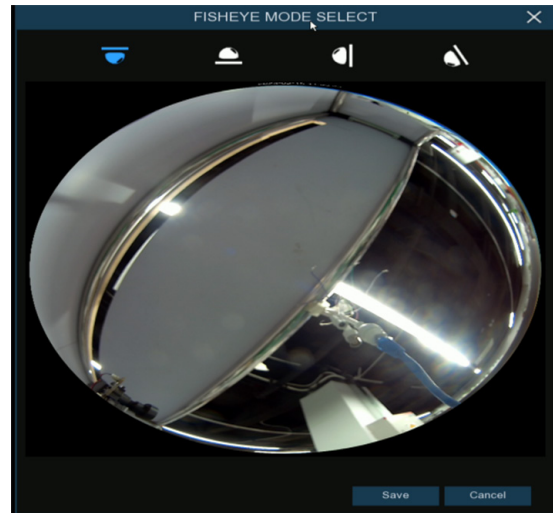

On the fisheye-mode operation page, click the  button on the toolbar at the bottom to open the menu for setting the fisheye camera installation mode.

Then, select the mode in accordance with the actual installation mode, and save the setting to make it take effect.

After the corresponding fisheye installation mode is set, the viewing modes supported in the selected installation mode are displayed on the toolbar at the bottom. You can switch the modes as needed and you can also drag and zoom the screen.



4.2.7 - Alarm Notification Panel

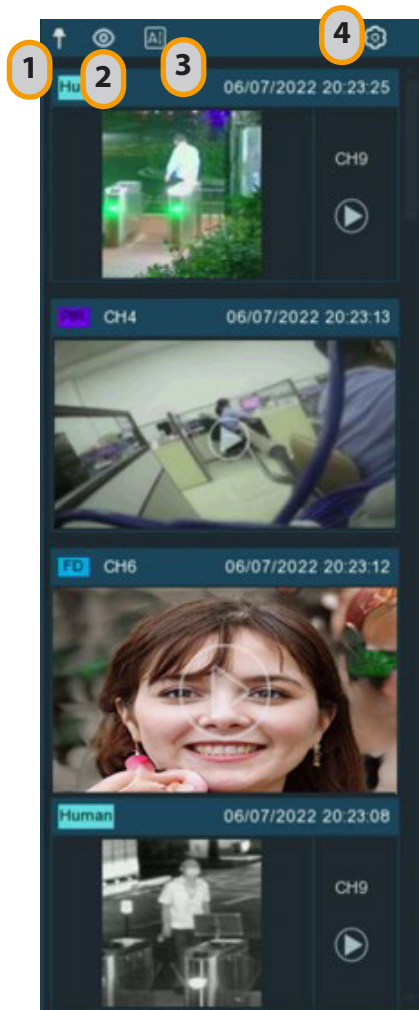

The Alarm Notification Panel displays thumbnails of alarm events that have occurred. Events are color-coded according to the event type. Use the mouse scroll wheel to scroll up and down (place the mouse cursor over the notification panel first). Click the play button next to or over the thumbnail to play the event.

1. Click to display the notification panel at all times.
2. Click to hide the notification panel.
3. Click to reveal AI statistics information.
4. Click to reveal the Filter and Statistics functions (shown below).

Use the Filter function to customize which alerts and which camera will appear in the notification panel. You can also customize the time duration and channels you want to display in AI statistics.

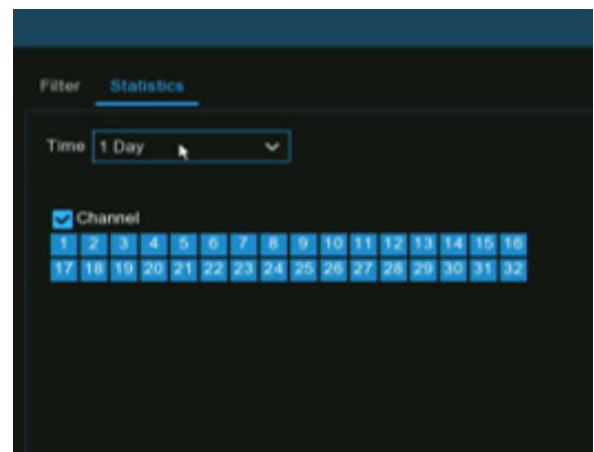

5 - SYSTEM SETUP

You are able to configure the NVR for Channel, Record, Alarm, Network, Device, System, AI, AI Scenario from Start Menu → Setup.

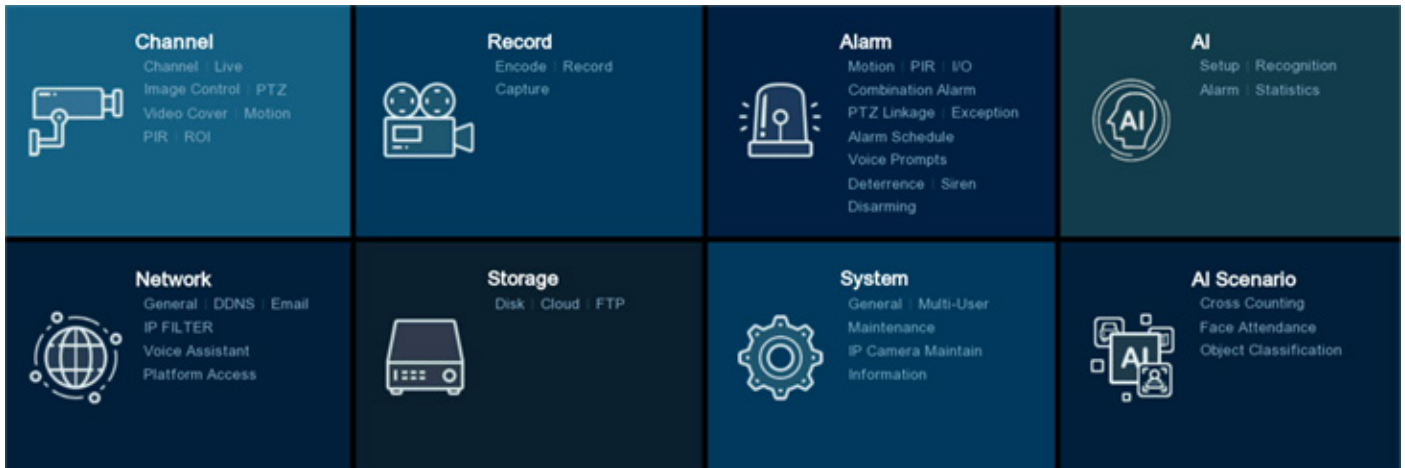

5.1 - Channel

In this section, you are able to manage the camera connection, live view display, camera's image, PTZ setup, video cover, motion setup, and more.

Setup Channel Record Alarm AI Network Storage System 2022-11-05 14:13:07

Channel

IP Channels POE Power

No.	Edit	IP Address/Hostname	Port	Channel Count	Manufacturer	Active state	Device Type	MAC Address	Software Version
1		172.20.53.22	80	1		Inactivated	30KQ	00-23-63-90-8D-5A	V31.35.8.2.3_221019
2		172.20.53.23	80	1		Activated	IP CAMERA	00-23-63-8B-A4-94	V31.35.8.2.3_221019
3		172.20.53.24	80	1		Activated	IP CAMERA	00-23-63-8B-A4-E0	V31.35.8.2.3_221019
4		172.20.53.26	80	1		Activated	IP CAMERA	00-23-63-94-06-C0	V35.45.8.2.3_220827
5		172.20.53.27	80	1		Activated	IP CAMERA	00-23-63-90-11-7C	V31.35.8.2.3_221019
6		172.20.53.28	9000	1		None	IP CAMERA	00-23-63-8F-44-E2	V12.45.7.1_210729
7		172.20.53.29	80	1		Activated	IP CAMERA	00-23-63-99-F2-2C	V1.0.0.B0001701020104_220719
8		172.20.53.33	80	1		Activated	IP CAMERA	00-23-63-91-EC-CE	V31.35.8.2.3_221019
9		172.20.53.37	9988	1		None	IP CAMERA	BC-51-FE-09-E1-05	V4.41.5.2_200301
10		172.20.53.43	80	1		Activated	IP CAMERA	00-23-63-94-7D-E9	V27.45.8.2.2_220608

Search Add Add All

Channel	Switch Mode	POE Mode	Edit	State	IP Address/Hostname	Subnet Mask	Port	Manufacturer	Device Type	Protocol	MAC Address	Software
POE CH7	Auto	Auto										
POE CH8	Auto	Auto										
POE CH9	Auto	Auto										
POE CH10	Auto	Auto										
POE CH11	Auto	Auto										
POE CH12	Auto	Auto										
POE CH13	Auto	Auto										
CH14	Manual	Auto			172.20.53.30	255.255.255.0	80	30KQ-Alarm	Private		00-23-63-9E-7B-D4	V31.35.8.2
CH15	Manual	Auto			172.20.53.34	255.255.255.0	80	IP CAMERA	Private		00-23-63-8B-E1-5D	V21.45.8.2
CH16	Manual	Auto			172.20.53.66	255.255.0.0	80	IP CAMERA	Private		00-23-63-97-17-46	V30.85.8.2

Auto Assign IP to Camera(s) Channel Delete Default Password Show Password

Total Band Width:112Mbps, Used Band Width:20.5Mbps

5.1.1 - Channel

You're able to add and delete IP cameras in this menu. If your NVR comes with PoE ports, you're able to check the PoE power consumption here.

EN

5.1.1.1 - IP Channels

To add or delete IP cameras here.















If your NVR comes with PoE ports, please go to 5.1.1.1.1 PoE NVR Connection.

If your NVR comes without PoE port, please go to 5.1.1.1.2. Connect External Cameras from LAN or Internet.

5.1.1.1.1 - PoE NVR Connection

For the PoE NVR, it is allowed to connect the IP cameras via the internal PoE ports and/or external LAN(WAN) port. PoE not only provides power over ethernet but only supports plug & play connection for IP cameras.

NOTE: It is not recommended to connect more than 1 camera via switch or router to the PoE port. One PoE port is allowed to connect one IP camera only.

Channel	Switch Mode	POE Mode	Edit	State	IP Address/Hostname	Subnet Mask	Port	Manufacturer	Device Type	Protocol	MAC Address	Software
POE CH1	Auto	Auto			10.10.25.151	255.255.0.0	80		IPCAMERA	Private	00-23-63-97-00-F6	V21.45.8.2
POE CH2	Auto	Auto			10.10.25.152	255.255.0.0	13182		OPD3	Private	00-23-63-8A-25-E5	V21.45.7.0
POE CH3	Auto	Auto			10.10.25.153	255.255.0.0	80		IP CAMERA	Private	00-23-63-92-CF-98	V31.35.8.2
POE CH4	Auto	Auto			10.10.25.154	255.255.0.0	9000		GW8537IP	Private	00-23-63-84-4E-B7	V14.45.5.0
POE CH5	Auto	Auto										
POE CH6	Auto	Auto										
POE CH7	Auto	Auto										
POE CH8	Auto	Auto										
POE CH9	Auto	Auto										
POE CH10	Auto	Auto										

Auto Assign IP to Camera(s) Channel Defaults Default Password Show Password

Total Band Width 256Mbps, Used Band Width 24.5Mbps

Switch Mode: Auto mode supports Plug & Play connection via PoE port. If you want to add camera(s) manually, click the edit icon  and then change the mode to be Manual, or you can click the drop-down arrow to change all channels to be Auto or Manual mode.

PoE Mode: with Auto mode, the maximum bandwidth is limited to 100Mbps. With ePoE mode, the maximum bandwidth is limited to 10Mbps and PoE transmission distance will be extended up to 200 meters with RJ45 cable at CAT 5E or above standard. If you have a connection problem with Auto mode when the IP camera is powered by PoE via a RJ45 cable longer than 100 meters, then change to ePOE mode for a stable connection. If the video is stuck while in ePoE mode, try to reduce the encoding bitrate.

Edit: To edit the Switch mode, PoE mode, network parameters, user name and password for individual camera.

State: Show the connection status of the camera.

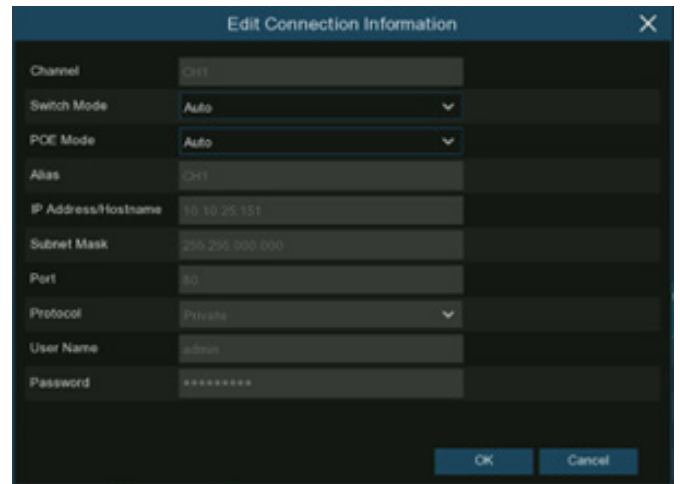

If the camera is successfully connected, the state will be displayed with a green icon

Channel	State	IP Address/Host
Auto		10.10.25.151
Auto		10.10.25.152
Auto		
Auto		

If the camera failed to connect, the state will be displayed with a grey icon

Click on the icon, a message will be pop-up to tell the failure reason.

If the failure reason is *"User name or password error"*, it means the camera user name and password is different from the default user name and password. Click the edit icon and then change to its correct user name and password.

If the failure reason is *"Failed to connect to camera, please check the network connection"*, it means the network parameter might be incorrect or incompatible ONVIF protocol. Click the edit icon and then change to correct network parameter.

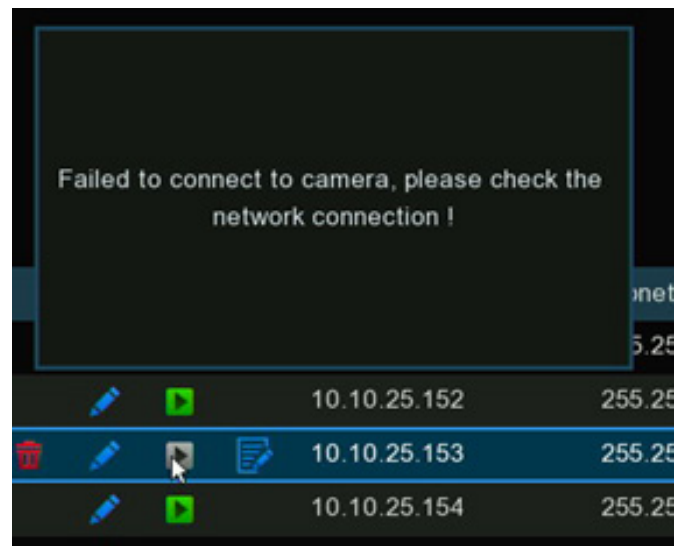
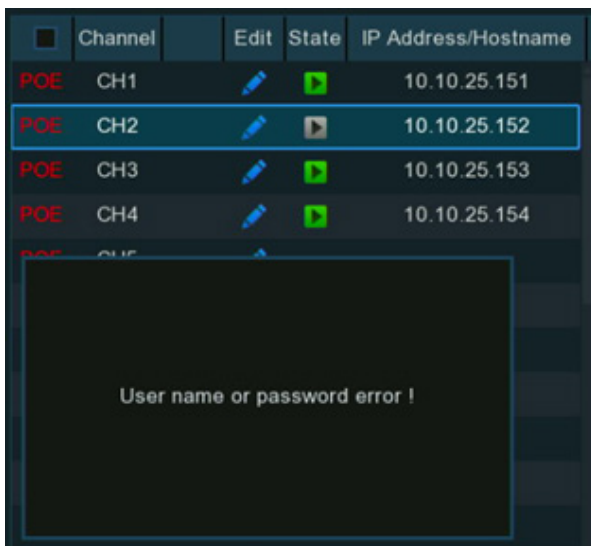

Auto Assign IP to Camera(s): If the camera you want to add manually is not in the same network segment, it might be failed to add the camera. You can use this function to change the IP address of the camera(s).

Default Password

To configure the default user name and password of Private, ONVIF and RTSP protocol connection. Default password is "admin". Please note, if the user name and password of the camera you added is not same with the default values, you may need to input the user name and password each time after the NVR restarting.

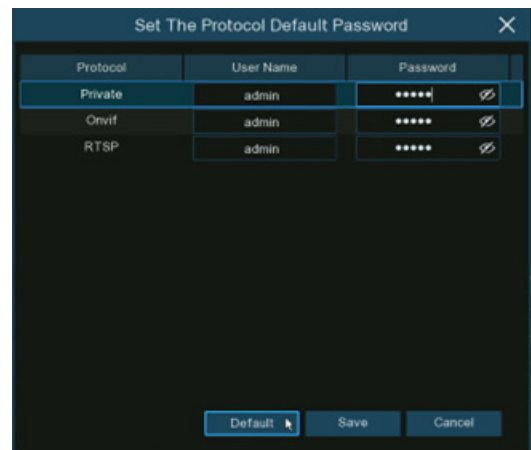

EN

Show Password

Tick to show the password of connected IP camera on the channel list.

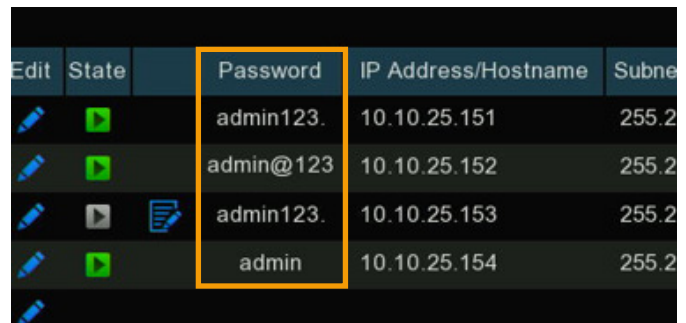

5.1.1.1.1 - Steps to Connect Plug & Play PoE Cameras

1. Keep the default settings.
2. Change the default user name and password to be same with the camera's.
3. Make sure your IP camera is set to DHCP IP address already. If your camera is set to static IP address which is different from the IP address segment inside the PoE router, your IP camera will be unable to get online. Check more in 5.5.1.1 Network → General.
4. Connect your IP camera into the PoE port on the rear panel.
5. Camera will be online and displayed in the camera list after its startup.

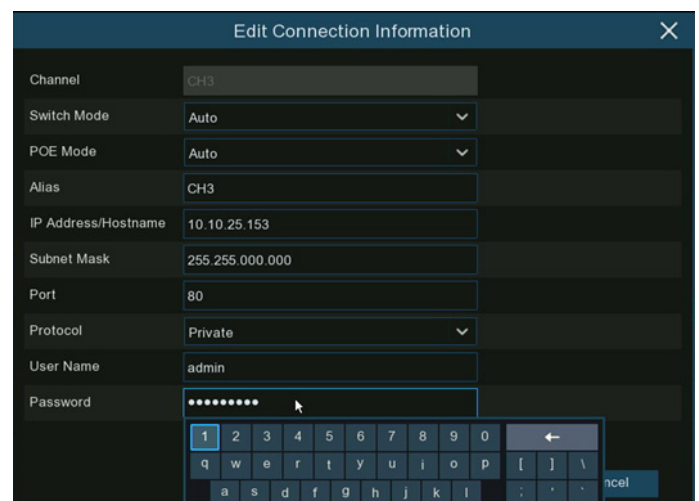



5.1.1.1.2 - Connect External Cameras from LAN or Internet

If you want to connect to an IP camera from LAN or internet, please make sure your NVR is well-connected to the LAN and or internet.

If your NVR come with PoE ports, you need to change the PoE Switch Mode to be manual firstly.

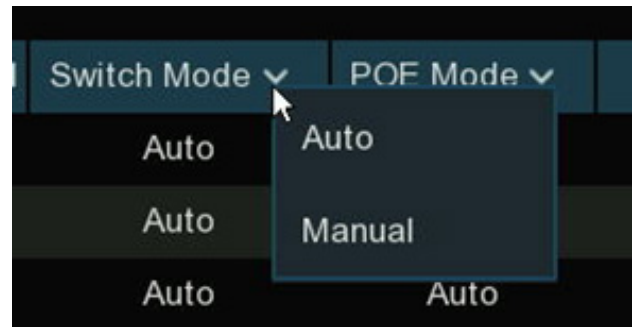
If you want to all channels manually, click the drop-down arrow next to Switch Mode, and then select **“Manual”**.



If you want to add an individual channel manually, click the edit icon  in the channel list, and then click the drop-down arrow next to Switch Mode to select **“Manual”** and click **OK** to save.

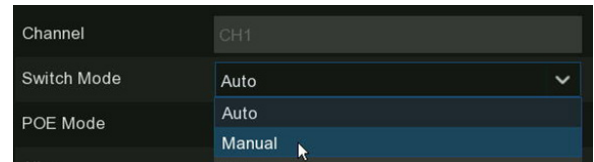

5.1.1.1.2.1 - Add Individual Camera in the LAN

1. Change the PoE mode to be Manual.
2. Click **Search** button, all available cameras in the LAN will be displayed.
3. Or click the Add icon  in the channel list to add a camera to an individual channel. Click **Search** button, all available cameras in the LAN will be displayed.
4. Click on the camera you want to connect, and then complete below parameters, and the input the user name and password of the camera and then click Add button.

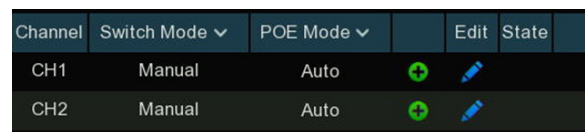
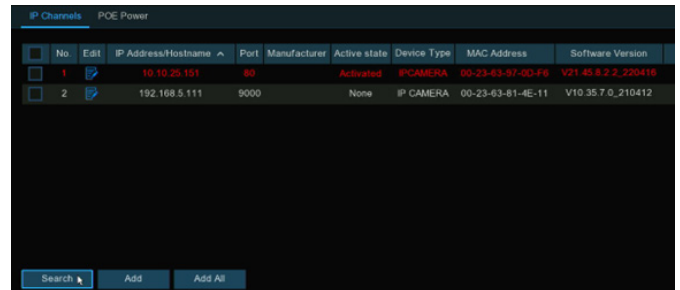

Alias: To define the camera ID title you want to display in the live view screen.

Port: Camera communication port.

Protocol: To select the connection protocol.

Bind channel: To determine which channel you want to add the camera.

Click **Add** button.

5. The added camera will be displayed in the channel list.

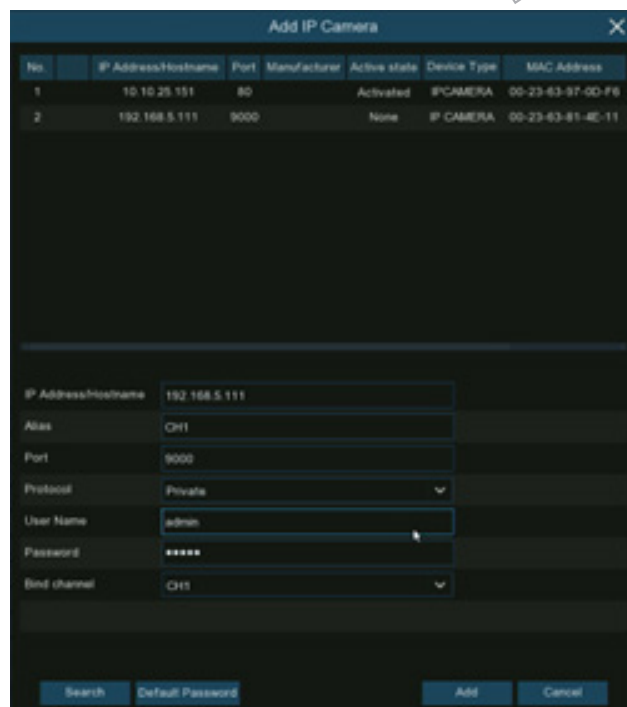

EN

Channel	Switch Mode	POE Mode	Edit	State	Password	IP Address/Hostname	Subnet Mask	Port	Manufac
CH1	Manual	Auto			admin	192.168.5.111	255.255.255.0	9000	
CH2	Manual	Auto							

5.1.1.1.2.2 - Add Multiplex Camera in the LAN

1. Click Search button, all available cameras in the LAN will be displayed. Or click Add All button, the NVR will search & add all available cameras in the LAN.
2. Select the cameras from the search result, and then click "Add". You would need to input the user name and password of the cameras. Please make sure all the cameras you want to add use the same user name and password. Otherwise, the cameras with different user name and password will be unable to get connected.
3. The added cameras will be displayed in the channel list.

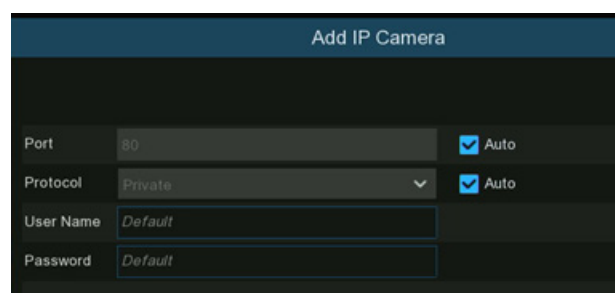
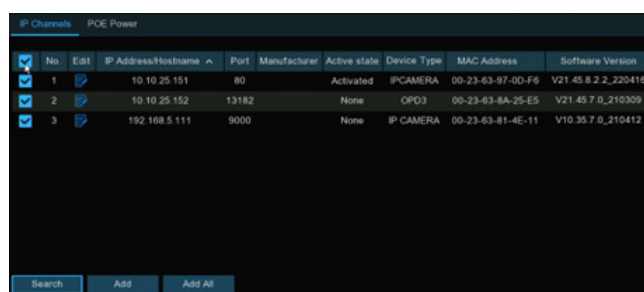

5.1.1.1.1.2.3 - Add Cameras from Other NVR in the LAN

The NVR allows to add cameras from other NVRs in the local network.

1. Click **Search** button, all available devices in the LAN will be displayed. There is an edit icon **+** displayed if the device is an NVR.

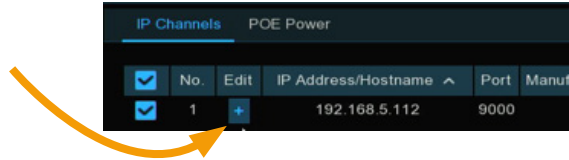

2. Click the edit icon **+** and select the camera channel one by one or tick the box to select all cameras. Click icon to go back to search list.

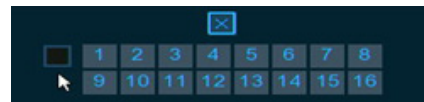

3. Select the NVR in the search list, and then click **Add** button.

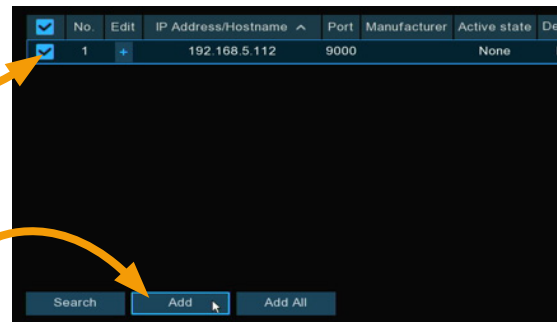

4. Input the user name and password of the NVR and then click **Add** button.

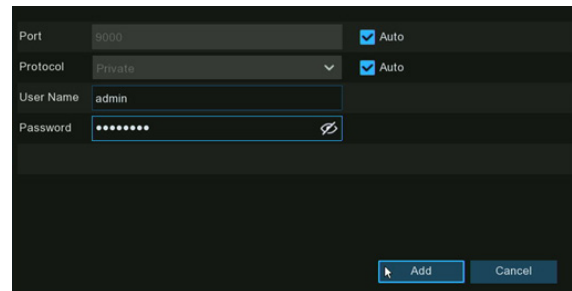

5. The added cameras will be displayed in the channel list.

Channel	Switch Mode	POE Mode	Edit	State	IP Address/Hostname
CH3	Manual	Auto			192.168.5.112-1
CH4	Manual	Auto			192.168.5.112-2
CH5	Manual	Auto			192.168.5.112-3
CH6	Manual	Auto			192.168.5.112-4

5.1.1.1.2.4 - Add Cameras from Internet

If your NVR is connected to internet, you're able to add cameras from internet with WAN IP address.

EN

1. Click **Add** button in the search page.

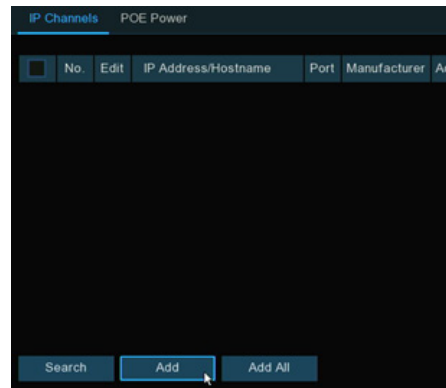

2. Input the IP address or domain name, port, protocol, user name & password of the IP camera. Click **Add** button to add the camera.

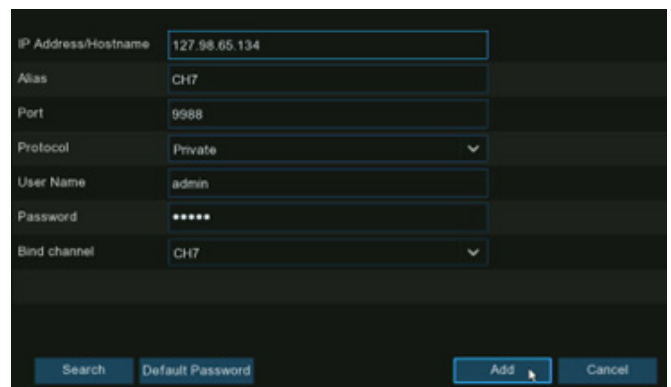

5.1.1.1.2 - Non-PoE NVR Connection

For Non-PoE NVR connection, please refer to 5.1.1.1.2 Connect External Cameras from LAN or Internet

5.1.1.2 - PoE Power

In this page, you will find the real-time power consumption of each PoE port, total actual power & rated power.

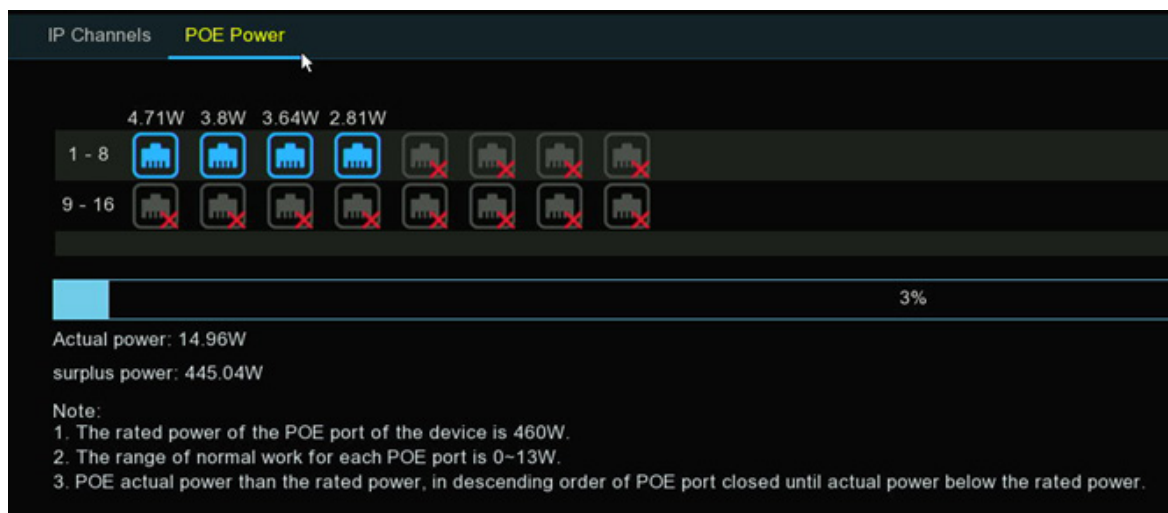

5.1.2 - Live

To configure camera parameters, including channel name, color, date & time format, refresh rate, etc.

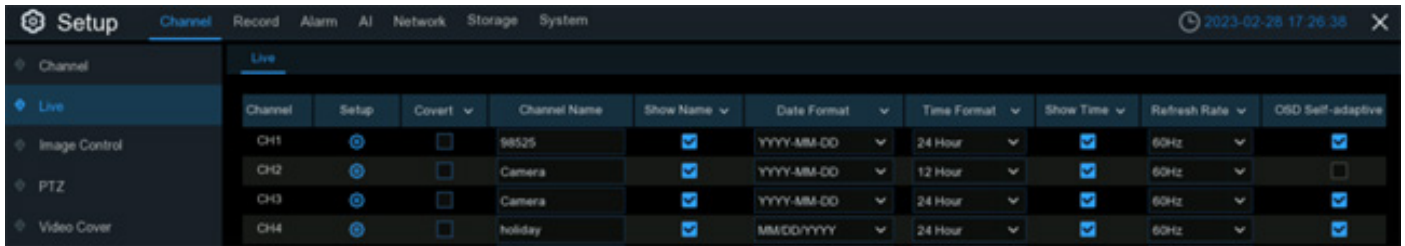

Channel	Setup	Covert	Channel Name	Show Name	Date Format	Time Format	Show Time	Refresh Rate	OSD Self-adaptive
CH1		<input type="checkbox"/>	98525	<input checked="" type="checkbox"/>	YYYY-MM-DD	24 Hour	<input checked="" type="checkbox"/>	60Hz	<input checked="" type="checkbox"/>
CH2		<input type="checkbox"/>	Camera	<input checked="" type="checkbox"/>	YYYY-MM-DD	12 Hour	<input checked="" type="checkbox"/>	60Hz	<input type="checkbox"/>
CH3		<input type="checkbox"/>	Camera	<input checked="" type="checkbox"/>	YYYY-MM-DD	24 Hour	<input checked="" type="checkbox"/>	60Hz	<input checked="" type="checkbox"/>
CH4		<input type="checkbox"/>	holiday	<input checked="" type="checkbox"/>	MMDD/YYYY	24 Hour	<input checked="" type="checkbox"/>	60Hz	<input checked="" type="checkbox"/>

Convert: To hide the camera images in live view. If the covert is enabled, only live view images will be hidden. Recording images won't be affected. Enable this if your NVR and TV is in a public area (shop, warehouse, etc.), but you don't want others to see an image from the camera.

Channel Name: Give a name to the camera

Show Name: Leave this enabled to display the camera name in Live View mode, otherwise click the checkbox to disable it. It affects both live view & recording images.

Date Format: To choose a date format.

Time Format: To choose a time format.

Show Time: Leave this enabled, as a timestamp will be embedded on all video recordings. Click the checkbox if you wish to disable it. It affects both live view & recording images.

OSD Self-adaptive: Used to set whether to change the font color of OSD in accordance with the screen background to ensure clear display.

Refresh Rate: Choose the right value according to the frequency of alternating current in your region.

Setup: Click  icon for more settings.

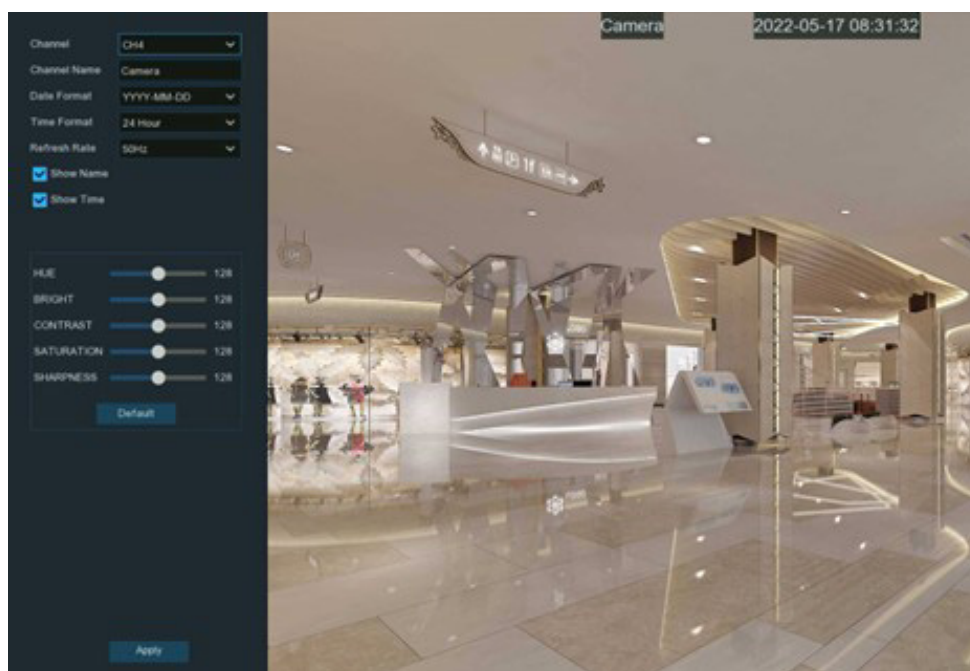

Channel: Select a channel to edit

Channel Name: Give a name to the camera

Date Format: To choose a date format

Time Format: To choose a time format

Refresh Rate: Choose the correct refresh rate

Show Name: To show or hide camera name

Show Time: To show or hide date and time

Alpha: Adjust the text transparency

This allows you to adjust how visible the OSD (camera name, date & time) will be in Live View mode. By increasing the value (move the slider to the right), you will see a surrounding rectangle underneath the OSD. This is beneficial for cameras that are pointing towards bright areas that make it hard to see the OSD.

HUE: Adjust the hue value which changes the color mix of the image.

BRIGHT: Adjust the brightness which changes how light the image appears to be.

CONTRAST: Adjust the difference in luminance that makes an object distinguishable.

SATURATION: Adjust the values to alters how much color is displayed in the image.

SHARPNESS: Used to adjust the image sharpness.

Click **Apply** to save settings.

Click **Default** to load default settings.

Click right button of your mouse to exit.

5.1.3 - Image Control

This menu allows you to control image settings for supported IP cameras. If the camera is connected to the NVR with ONVIF protocol, it might be not supported to configure.

Channel	Setup	Image Setting	IR-CUT Mode	IR-CUT Delay	Lens Flip	Angle Flip	Angle Triad	BLC Level	3D Noise Reduction	DWDR	AGC	White Balance	Time Exposure
CH1	🔘	Day/Night Mode	Automatic mode	2	OFF	OFF	180	OFF	Auto	OFF	Auto	Auto	Auto
CH2	🔘	Day/Night Mode	Image	2	OFF	OFF	180	OFF	Auto	OFF	Auto	Auto	1/30
CH3	🔘	Day/Night Mode	Automatic mode	2	OFF	OFF	180	OFF	Auto	OFF	Auto	Auto	Auto
CH4	🔘	Day/Night Mode	Automatic mode	2	OFF	OFF	180	OFF	Auto	OFF	Auto	Auto	Auto
CH5	🔘	Day/Night Mode	Image	2	OFF	OFF	180	OFF	Auto	OFF	Auto	Auto	Auto
CH6	🔘	Day/Night Mode	Automatic mode	2	OFF	OFF	0	OFF	Auto	OFF	Auto	Auto	Auto

Setup: Click icon into the setup page.

Channel: Choose a channel to configure.

IR-CUT Mode: Lets you choose how the camera handles color and how it manages the transition from daytime to night-time and vice versa:

- **GPIO AUTO** will instruct the camera to switch automatically from “Color Mode” to “Black White mode” and vice versa. It is accomplished through the light sensor.
- **Color Mode** will instruct the camera to operate in color mode only. In low light conditions, the color will be quite faint. Image clarity will also be reduced in low-light conditions.
- **Black White Mode** will instruct the camera to operate in black & white mode only.
- **Image Mode** will instruct the camera to switch automatically from “Color Mode” to “Black White mode” and vice versa. It is accomplished through the software.
- **Schedule** allows to set the images as black & white color in a certain duration.

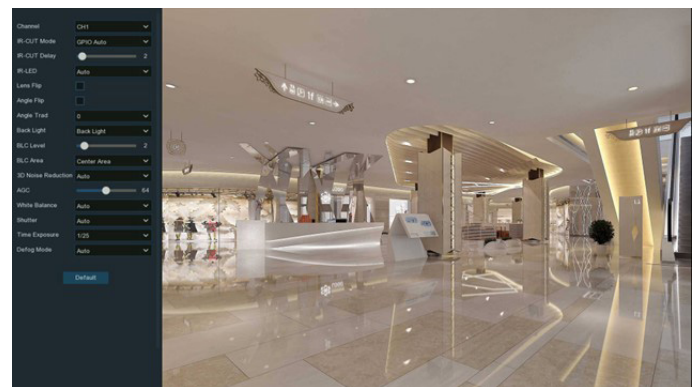

IR-CUT Delay: Controls the delay of the IR cut filter when transitioning from daytime to night-time. The default setting will be suitable for most camera locations but can be adjusted if needed. Click and hold the slider left or right to change. The higher the number, the greater the delay.

IR-LED: To configure the IR LRD lighting method.

- **Smart IR:** If you want the LED lighting to be managed by the system, then select this.
- **Manual:** You’re able to configure the brightness of the LED lights including low-beam lights and high-beam lights individually.
- **OFF:** Turn off the LED light always

Lens Flip & Angle Flip: Turn the image upside down and/or horizontally reverse the orientation of the image.

Corridor Mode: This allows you to make better use of the camera’s vertical angle for an optimized view of long, narrow scenes. Enable this if your camera is viewing a narrow corridor.

Angle Rotation: Rotate the image 180°.

Back Light: When the surrounding illumination and the object have large differences in brightness, you can enable the exposure compensation to get a better image.

- **WDR/DWDR:** Images produced by wide dynamic range (WDR) function sensors can have proper exposure on both the darker and lighter parts of the image, giving more detail across a wider dynamic range between the shadows and highlights by brightening dark areas and darkening bright areas. If it is enabled, click and hold the slider left or right to change the WDR Level.
- **HLC:** High Light Compensation (HLC) allows your camera to compensate for brighter parts of your image, maintaining detail in brighter parts of the image that would otherwise be blown out. When you enable HLC, the camera will take bright spotlight-like areas into consideration and adjust the exposure accordingly. With HLC, your camera will try to properly expose your entire scene while reducing the brightness of the highlights. If it is enabled, click and hold the slider left or right to change the HLC Level.
- **Back Light:** Back Light Compensation (BLC) allows you to choose which areas of your scene should be properly exposed instead of letting the camera choose for you. By enabling BLC, the camera over-exposes the brighter parts of your image in order to properly expose the darker parts. If it is enabled, click and hold the slider left or right to change the BLC Level.
- **Disable:** Disable exposure compensation.

3D Noise Reduction: Used to reduce the noise in the image so as to make the image clearer. There are three mode options.

- **Auto:** In this mode, the camera automatically selects the noise reduction effect in accordance with algorithms.
- **OFF:** The noise reduction function is disabled.
- **Manual:** In this mode, image noise is reduced in accordance with the noise reduction coefficient manually configured.

White Balance: Used to set white balance. There are two mode options.

- **Auto:** In this mode, the white light is adjusted by the default parameters.
- **Manual:** In this mode, you can manually set the synthetic gained white light of red, green, and blue.

Shutter: Used to set the shutter exposure time. There are two mode options.

- **Auto:** In this mode, a proper exposure time is automatically selected in accordance with the configured Time Exposure value.
- **Manual:** In this mode, the configured Time Exposure value is used.

Time Exposure: Used to set the exposure time of the camera. This parameter is used together with the Shutter parameter.

AGC: Used to set Automatic Gain Control (AGC). (It is supported by some models.)

Defog Mode: Used to set defog mode to optimize the display effect in foggy days. There are three mode options.

- **OFF:** The defog function is disabled.
- **Auto:** In this mode, the camera automatically judges the defog effect.
- **Manual:** In this mode, defogging is performed in accordance with the manually configured value.

Default: Click this button to restore the default image parameter setting.

5.1.3.1 - Full Color Camera Settings

If there is a full color camera connected to the NVR, an **Image Setting** option is displayed under the **Image Control** setting page.

Full color camera includes not only IR LEDs, but also white light LEDs. You're able to determine the operating mode of the lights:

- **Day/Night Mode:** the camera will be working as a normal IR LED camera.
- **Full Color Mode:** the camera will be working as a full color camera. You're able to configure the brightness of white lights:
 - **Auto:** The brightness of the lights will be controlled by the system automatically according to the brightness of images.
 - **Manual:** The brightness of the lights will be controlled manual. You're able to set a fixed value in the **Light Brightness** bar. The higher the number is, the brighter the lights are. Lights will be turned off if the value is set to 0.

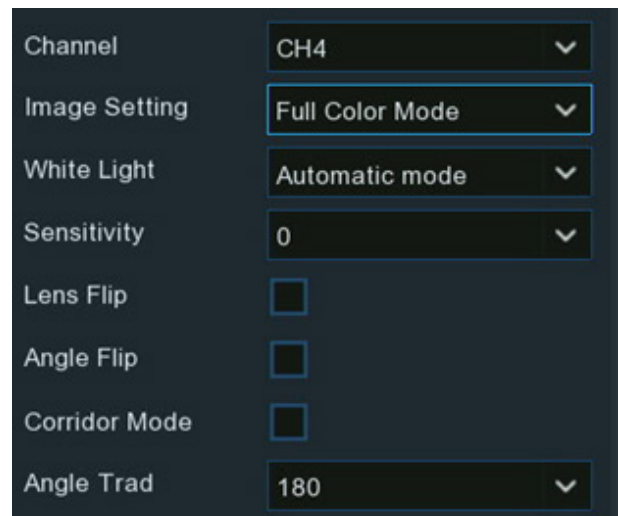

Schedule: You're able to set the white lights turned on or turned off in certain durations. Each square represents 30 minutes. Using the mouse, click on a particular square to change or click and drag the mouse over the squares corresponding to your desired period. The white lights will be turned on if the time table is in blue color, oppositely the lights will be turned off if the time table is in black color.

- **OFF:** Turn off the white lights.
- **Sensitivity:** The higher the number is, the more sensitive the system will be to light up the white lights and vice versa.
- **Schedule:** the lights will be working according to the schedule. Camera works in full color mode if the time table is in blue color, oppositely the camera works in day & night mode if the time table is in black color.

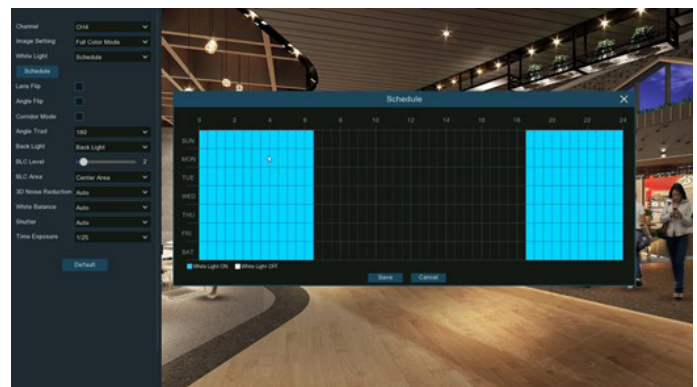

5.1.4 - PTZ

This menu allows to configure the PTZ (Pan/Tilt/Zoom) settings for the speed dome cameras.

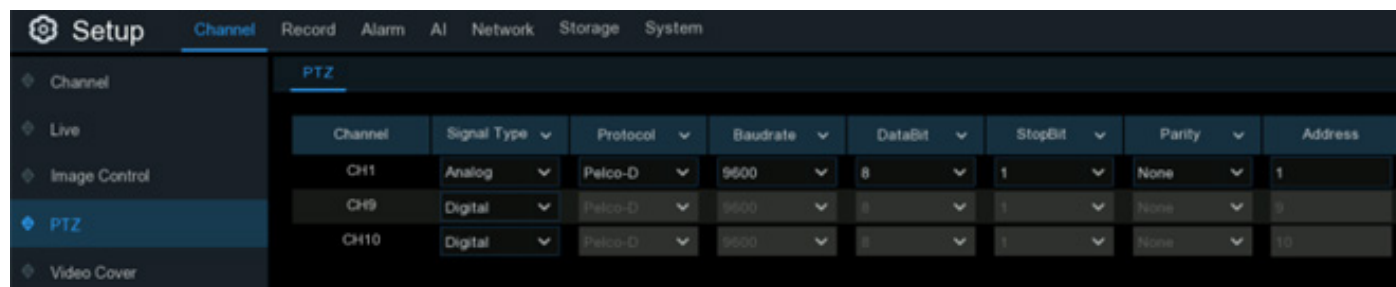

Channel: Channel name

Signal Type: If your PTZ camera is connected to the RS485 port, then choose “**Analog**”, otherwise choose “**Digital**”.

Following items are available only for Analog PTZ only:

Protocol: Choose the communication protocol between the PTZ capable camera and NVR.

Baudrate: The speed of the information sent from the NVR to the PTZ-capable camera. Make sure it matches the compatibility level of your PTZ-capable camera.

DataBit / StopBit: The information between the NVR and PTZ-capable camera is sent in individual packages. The **DataBit** indicates the number of bits sent, while the **StopBit** indicates the end of the package and the beginning of the next (information) package. The available parameters for **DataBit** are: 8, 7, 6, 5. The available parameters for the **StopBit** are 1 or 2.

Parity: For error check. See the documentation of your PTZ camera, to configure this setting.

Address: Set the command address of the PTZ system. Please be noted that each PTZ-capable camera needs a unique address to function properly.

5.1.4.1 - MFZ & PTZ Control

In live viewing, click the left button of your mouse on a connected camera to pop up the Camera Quick Toolbar.

Click the PTZ icon  to enter PTZ control panel.



5.1.4.1.1 - Controlling Your MFZ Camera

You're able to adjust the optical lens to zoom in or zoom out if a MFZ (Motorized Focus & Zoom) camera is connected.

In live viewing, click the left button of your mouse on the MFZ camera to pop up the Camera Quick Toolbar. Click the PTZ button  to enter MFZ control panel.

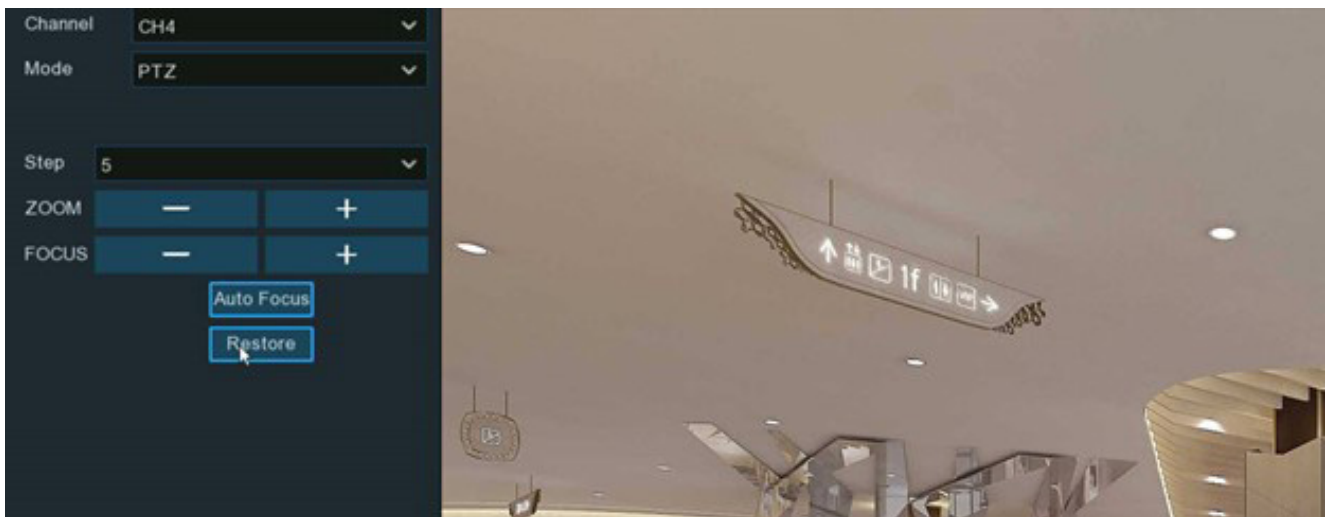

Step: To set the steps of each movement of the MFZ lens

Zoom: To control the zoom in and zoom out:

- Single click on the button, the lens will perform one movement to zoom out the image and auto focus. Click and hold on the button to perform continuous movements till you release the mouse button.
- + Single click on the button, the lens will perform one movement to zoom in the image and auto focus. Click and hold on the button to perform continuous movements till you release the mouse button.

Focus: To fine turn the focus by manual:

- A single click on the button, the lens will perform one movement to focus out the image. Click and hold on the button to perform continuous movements till you release the mouse button.
- + A single click on the button, the lens will perform one movement to focus in the image. Click and hold on the button to perform continuous movements till you release the mouse button.

Auto Focus: Auto focus on the objects.

Restore: Restore the camera to default status.

5.1.4.1.2 - Controlling Your PTZ Camera

In live viewing, click the left button of your mouse on the PTZ camera to pop up the Camera Quick Toolbar. Click the PTZ button  to enter PTZ control panel.

EN



Mode: To control the PTZ camera by PTZ, Preset, Line Scan, Watch Mode, Tour and Pattern Scan.



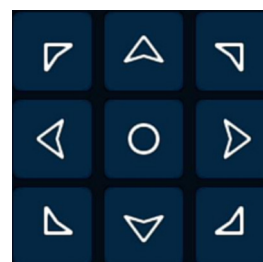

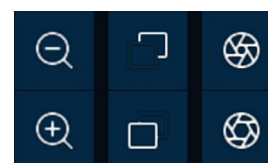

Directional Buttons: Click and hold the directional buttons to move the camera in the direction selected. Click the middle button  to continually rotate the camera towards the left (click the any directional button to stop). If you want to change the rotation speed, you need to stop the rotation firstly, and then start again after changing the speed.



Speed: Adjust the speed control to alter how fast or slow the camera will pan or tilt. Move the slider to decrease or increase the speed.



Lens Control Buttons: To control the optical zoom, focus length and iris of the lens.

-  Single click on the button, the lens will perform one movement to zoom out the image and auto focus. Click and hold on the button to perform continuous movements till you release the mouse button.
-  Single click on the button, the lens will perform one movement to zoom in the image and auto focus. Click and hold on the button to perform continuous movements till you release the mouse button.
-  Click and hold the button to decrease the focal length.
-  Click and hold the button to increase the focal length.
-  Click to reduce the iris value, image will get darker.
-  Click to increase the iris value, image will get brighter.

5.1.4.1.2.1 - Controlling PTZ

In this section, you're able to control the Pan/Tilt/Zoom and more.

- 1 – Select PTZ mode.
- 2 – Click the directional buttons to move the camera
- 3 – To adjust the speed to pan or tilt.
- 4 – To control the optical zoom, focus and iris of the lens.
- 5 – Using functional buttons

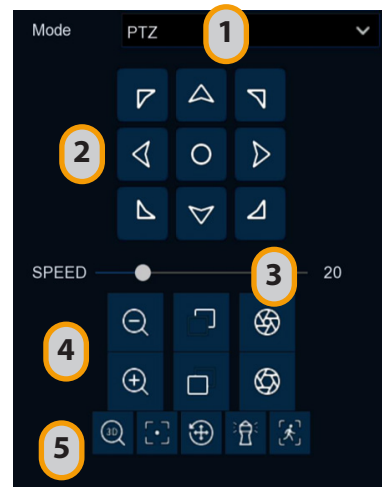

3D PTZ control. After clicking on this button, you're able to control the pan/tilt/zoom directly on the live view screen.

- Click on any point in the image, and then the image will be centered on the clicked point.
- Drag: You can zoom in or zoom out the image by dragging your mouse on the image:
- Click on the image and hold the mouse to drag a rectangle from point A to point B, the camera will zoom in to get the objects closer.
- Click on the image and hold the mouse to drag a rectangle from point B to point A, the camera will zoom out to get the objects farther.



Auto focus.

Load default values. All the parameters you set will be lost and restored to default values.

Start or stop Watch Mode. See more on 5.1.4.1.2.3 Watch Mode.

If your PTZ camera supports auto tracking on the movement of human beings, you're able to control the tracking by manual if there are several detected targets to let the camera focused on a certain target. Before using this function, please make sure you have already activated the human detection function and enable the PTZ auto tracking function, view in 5.4.1.2. PD & VD (Human & Vehicle Detection).



Click the button, and then click and hold your mouse on the live view screen, drag a rectangle with yellow line to frame the targeted person. The camera will focus on the select person till he/she disappears from view.

5.1.4.1.2.2 - Preset Position

In this section, you're able to configure the preset positions. A preset position is a particular position within the image that you would like the camera to focus on. Up to 255 different preset positions can be created.

EN



- 1 – Select **PRESET** mode.
- 2 – Adjust the speed control to alter how fast or slow the camera will pan or tilt.
- 3 – Click and hold the directional buttons to move the camera in the direction selected.
- 4 – Change the optical zoom, focus and iris of the lens if needed.
- 5 – When the position is fixed, change the length of time (in seconds) the camera will stay at this position, before moving to the next position.
- 6 – Click the add button to create the preset point.
- 7 – Repeat step 1 to 6 to add more preset positions. The saved preset positions will be displayed with blue background.
- 8 – Click the **GO TO** button → , the camera will then move to that selected position.
- 9 – Click **Start Cruise**, the camera will move to the preset positions in sequence. Click **Stop Cruise** to stop.
- 10 – You can give a name to the preset position.
- 11 – You can delete the preset position by clicking the Clear button 🗑️ .
- 12 – Click the visual icon 📺 , you will see the thumbnail of preset position is displayed on the bottom of the live view image. You can go to, delete or add a preset position in the visual interface.





5.1.4.1.2.3 - Watch Mode

Watch mode allows the camera to perform a preset action when there is no any operation to the camera, such as moving to a preset position, starting cruise, etc.

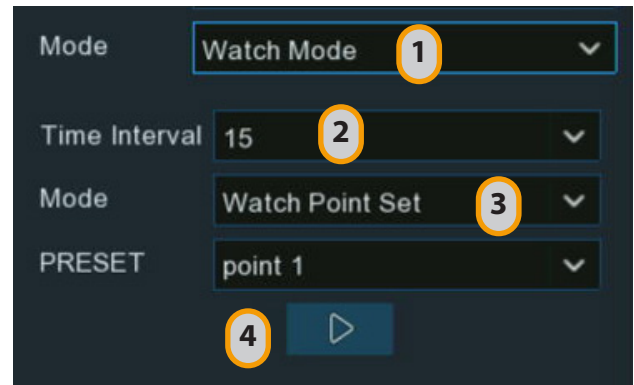



- 1 – Select the **Watch Mode**.
- 2 – Set the time interval. It means the length of time that must elapse before the watch mode is taken action. For example, the watch mode is activated and the interval is set to 15, the camera will perform the watching action if there is no operation to the camera in 15 seconds.
- 3 – Choose the action when the watch mode is activated:



- **Default Cruise:** The camera will be continually rotated towards the left
 - **Preset Position:** The camera will be moved to a selected preset position and stay.
 - **Line Scan:** The camera will be implemented the Line Scan. See more on 5.1.4.1.2.4 Line Scan.
 - **Tour:** The camera will be implemented the Tour. See more on 5.1.4.1.2.5 Tour.
 - **Pattern Scan:** The camera will be implemented the Pattern Scan. See more on 5.1.4.1.2.6 Pattern Scan.
- 4 – Click  button to start the Watch Mode.
Press  button to stop.

5.1.4.1.2.4 - Line Scan

Line Scan allows the camera to automatically cruise between position A to position B horizontally.

- 1 – Select **Line Scan** mode.
- 2 – Adjust the speed control to alter how fast or slow the camera will pan or tilt.
- 3 – Click and hold the directional buttons to move the camera in the direction selected.
- 4 – Change the optical zoom, focus and iris of the lens if needed.
- 5 – When the first position is fixed, click  button to record this position A. Repeat step 3 & 4 to move the camera to another position. Click  to record the position B.
- 6 – Adjust the cruise speed.
- 7 – Click  button to start Line Scan.
Press  button to stop.

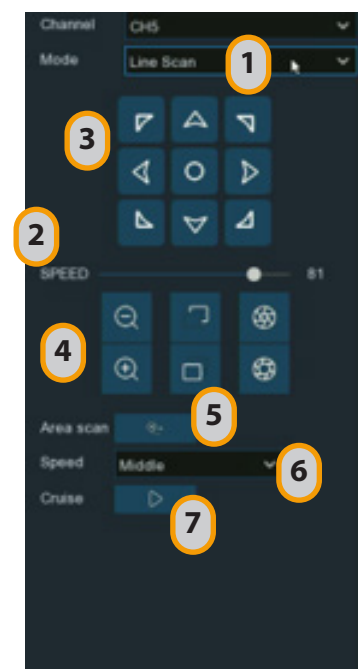

5.1.4.1.2.5 - Tour

With the Tour function, you're able to configure maximum 4 tracks of auto cruise by choosing different preset positions.

EN

- 1 – Select **Tour** mode.
- 2 – Select a track. Maximum 4 tracks available.
- 3 – Set the time interval. It means the length of time that the camera will stay in each preset position.
- 4 – Click add button **+**, position box will be added and displayed in the position list. Click the box to choose a preset position. Maximum 32 positions can be added to a track.
- 5 – Click on the blank area on the right side of the position box, and then delete the preset position by clicking the delete button **🗑**, or click button **▲** / **▼** to change its sequence.
- 6 – Click **▶** button to save and start the tour. Press **⏏** button to stop.

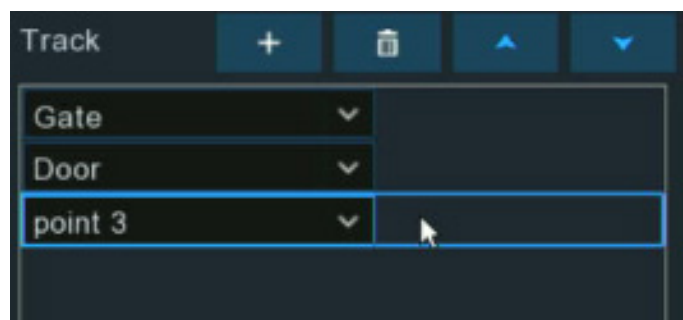
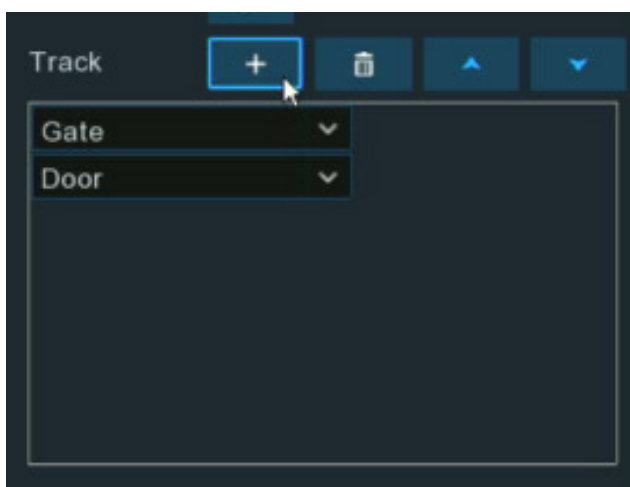
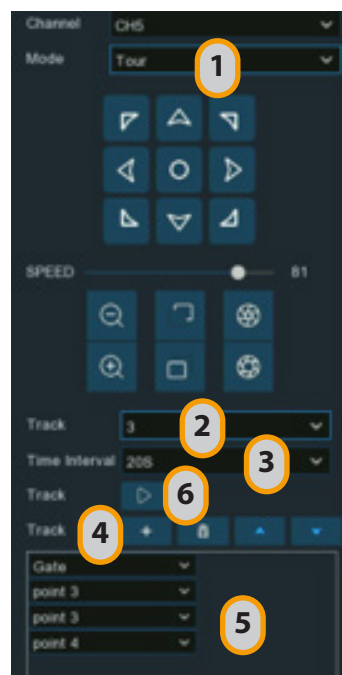

5.1.4.1.2.6 - Pattern Scan

With the Tour function, you're able to configure maximum 4 tracks of auto cruise by choosing different preset positions.

- 1 – Select **Pattern Scan** mode.
- 2 – Select a track. Maximum 4 tracks available.
- 3 – Adjust the speed control to alter how fast or slow the camera will pan or tilt.
- 4 – Click and hold the directional buttons to move the camera in the direction selected.
- 5 – Change the optical zoom, focus and iris of the lens if needed.
- 6 – When the start position is fixed, click ▶ button to start recording. Repeat step 4 & 5 to adjust the position. Press □ to finish the recording of route.
- 7 – Click ▶ button, the camera will be moved exactly same as the route which was recorded in step 6, including zoom, focus, direction. Press □ to stop.

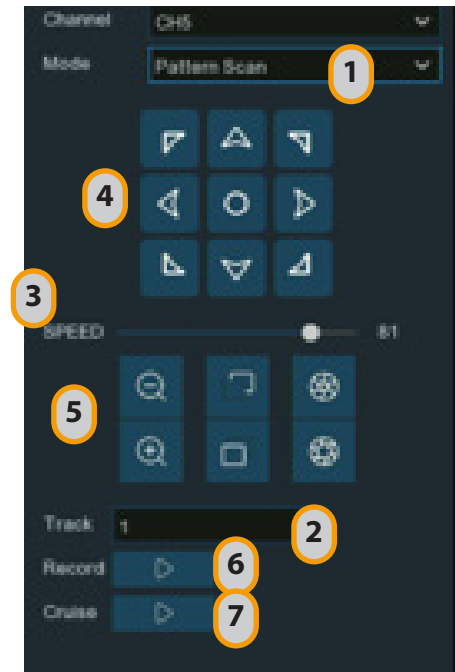

5.1.5 - Privacy Zone

This function can obscure all or part of your image for privacy (you can create up to 4 privacy masks per camera). Areas obscured by a mask won't be shown live or recorded.

EN

Channel: Select a camera that you would like to edit.

Enable Privacy Zone: Tick to enable this function.

Area 1 to 4: Click the checkbox on the number of privacy masks that you want to enable. Up to 4 privacy masks can be enabled per camera. Depending on the number of privacy masks enabled, one or more masks will appear in the Live View windows.

Depending on the number of masks that you want to enable, each mask will be numbered. To reposition the mask, click and hold inside the mask then move the mask to the desired location.

To resize the mask, click and hold the bottom right corner of the mask then resize to the desired size. You can reposition and resize each mask to overlap each other.

When finished, click **Apply** to save. Areas obscured by a mask won't be shown live or recorded.

To remove a mask, uncheck the checkbox next to the relevant area, then click **Apply** to save.

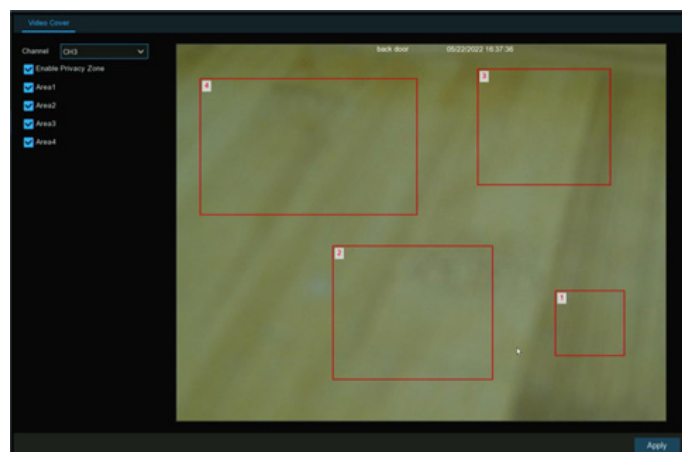

5.1.6 - Motion Detection

This menu allows you to configure motion parameters. When motion has been detected by one or more cameras, your NVR will alert you to a potential threat at your home. It does this by sending you an email alert with an attached image from the camera to use as a reference (if this option is enabled) and/or sending push notifications via the mobile app.

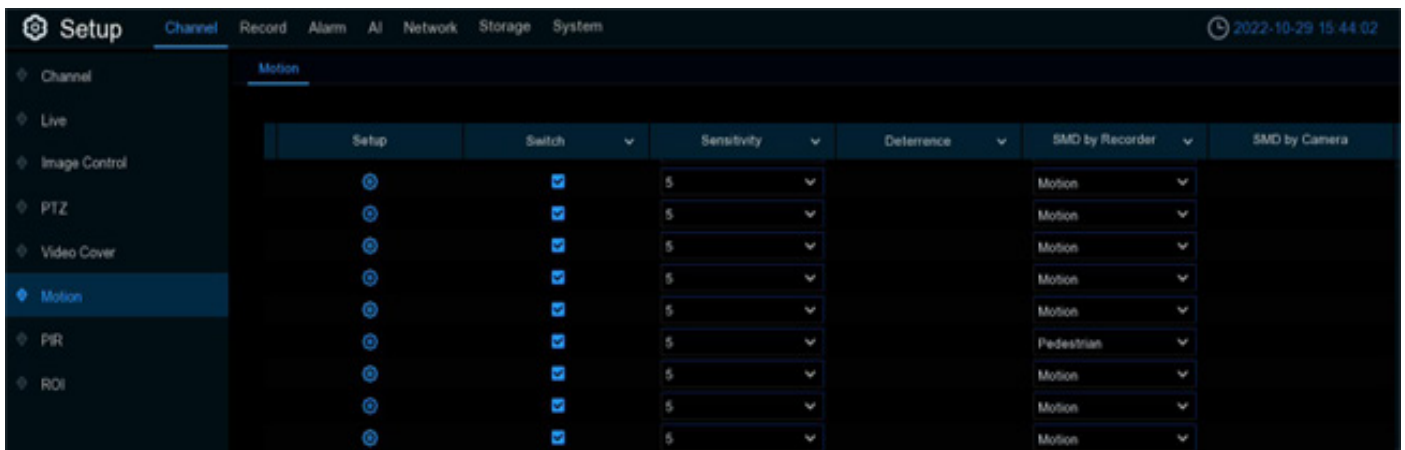

Switch: Enable or disable motion detection.

Sensitivity: This option allows you to change the sensitivity level. The higher the number, the more sensitive your NVR will be when detecting motion.

SMD by Recorder: Used for the cameras that do not support intelligent motion detection.

SMD by Camera: Used for the IP cameras that support intelligent motion detection.

There are four detection types available: Motion, Human, Vehicle, and Vehicle&Human.

- **Motion:** The camera will detect all motion events, including movements of human beings, vehicles, animals, trees, etc.

If your camera or NVR supports smart motion detection (SMD), you'll be able to choose below advanced motion detection targets:

- **Human:** The camera only alert when the movements of human beings are detected.
- **Vehicle:** The camera only alert when the movements of vehicles are detected.
- **Vehicle & Human:** The camera only alert when the movements of human beings and/or vehicles are detected.

Motion Detection Area Setup: Click icon into the setup page.

1. The whole screen is marked for motion detection (red blocks) as default. Click **Clear All** to delete all the default detection area.
2. To create a new detection area, press and hold the left mouse button to select the cell or square that you want to start at, then click and drag to select the area that you want to create. Release the mouse to finish.
3. Multiple areas can be created. Each cell or square can be enabled to detect motion. The same action also applies when deleting an area.
4. Movement outside of the motion detection areas won't be detected therefore will not trigger recordings or event notifications.
5. Adjust the sensitivity if required, then right-click the mouse to exit.
6. Click **Apply** to save changes made.

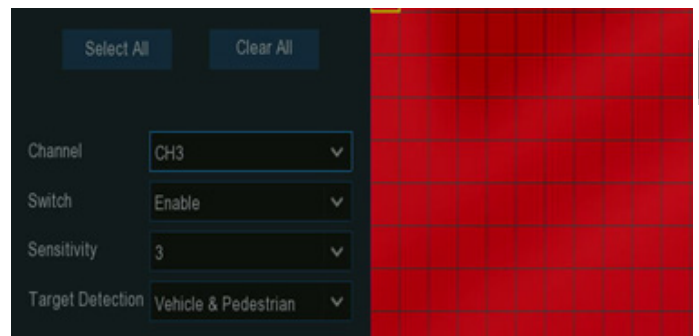

EN

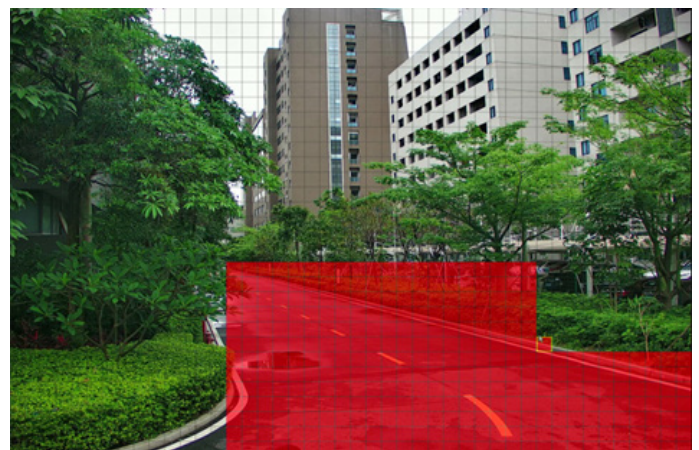

5.1.6.1 - Motion Alarm Settings

Click the **Alarm** button to change options for alarm notifications and more.

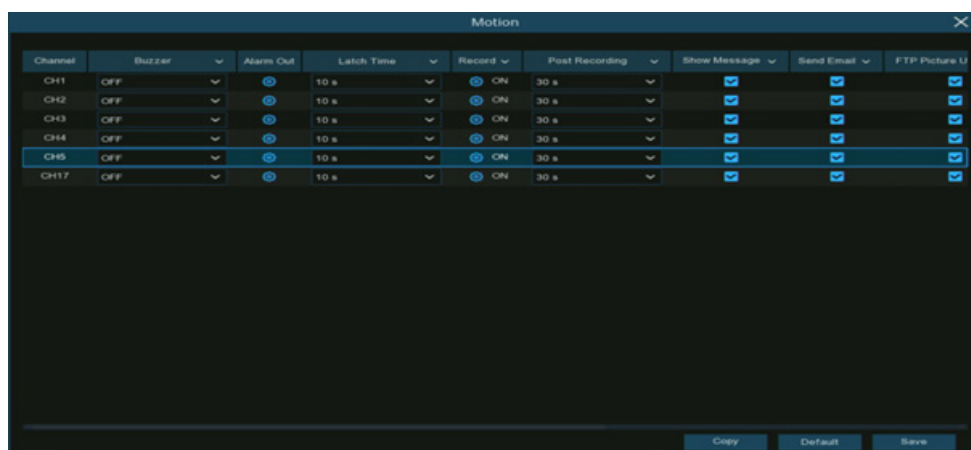
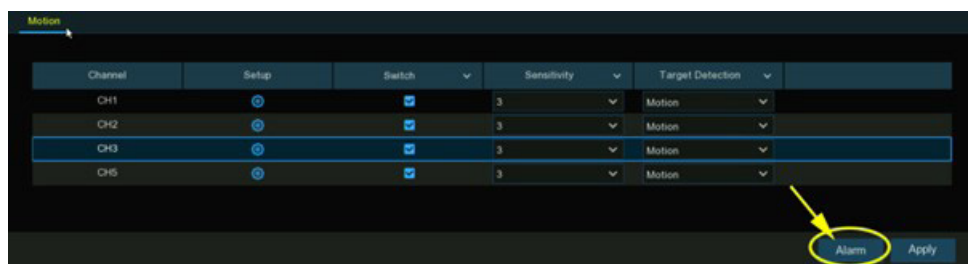

Buzzer: When motion is detected, you can enable the NVR's buzzer to alert you for a predetermined amount of time. Click the drop-down menu to select a time.

Alarm Out: If your NVR or IP camera supports to connect external replay output devices, the system can send an alert message to the external alarm devices. Click  button, to choose the external alarm devices:

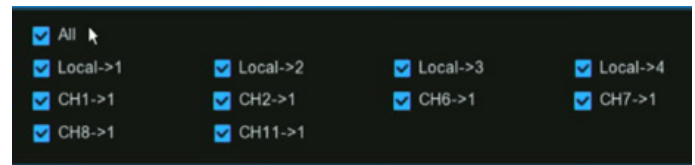

Local: External alarm devices connected to the NVR.

CHx->1: External alarm devices connected to IP cameras.

Latch Time: To configure the external alarm time when the detection is triggered.

Record: This option instructs your NVR to trigger additional cameras to start recording when motion is detected. Click the drop-down arrow to choose all channels to be recorded or not.

Click  icon, click the **Record Channel** checkbox to enable recording. Click the checkbox in front of the channel number to select all channels or click on the individual camera number that you want to trigger for recording.

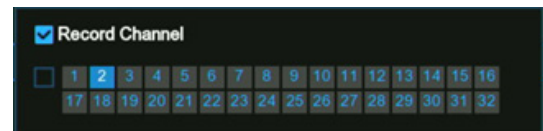

Post Recording: This option instructs your NVR to record for a set time after an event has occurred. For most instances, the default selection will be suitable, however, you can change this if you wish.

Show Message: When the detection is triggered, the alarm icon  will appear on screen.

Send Email: An email alert will be sent when alarm event is detected. Tick the checkbox if you want to disable this.

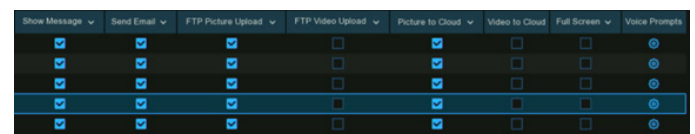

FTP Picture Upload: Click the checkbox to copy snapshots to your ftp server when the detection is triggered.

FTP Video Upload: Click the checkbox to copy videos to your ftp server when the detection is triggered.

Picture to Cloud: Click the checkbox to copy snapshots to the cloud via Dropbox or Google Drive when the detection is triggered.

Video to Cloud: Click the checkbox to copy videos to the cloud via Dropbox or Google Drive when the detection is triggered.

Full Screen: Click the checkbox to view the camera full-screen in Live View mode when the detection is triggered.

Voice Prompts: If your NVR connects with a speaker, you can select a customized alert voice when the detection is triggered. See how to add customized alert voice on 5.3.9 Voice Prompts.

Default: Click **Default** to revert to default settings.

Copy: Use the **Copy** function to apply all settings to the other connected cameras.

Save: Click **Save** to save settings.

5.1.7 - PIR

This menu allows you to configure PIR (passive infrared motion detector) parameters. When PIR alarm has been detected by one or more cameras, your NVR will alert to you a potential threat. It does this by sending you an email alert with an attached image from the camera to use as a reference (if this option is enabled) and/or sending push notifications via the mobile app.

EN

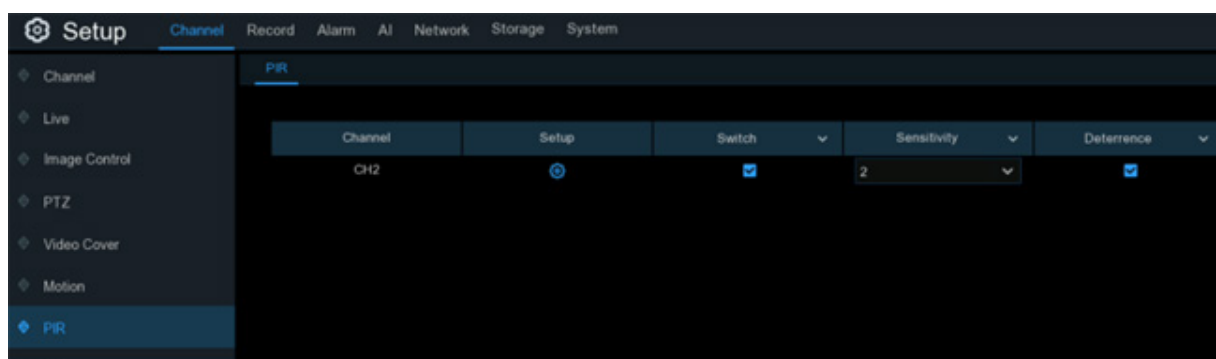

Switch: Enable or disable PIR detection.

Sensitivity: This option allows you to change the sensitivity level. The higher the number, the more sensitive your NVR will be when detecting PIR.

Deterrence: Tick to light up the built-in white lights of your PIR camera.

PIR Detection Area Setup: Click  icon into the setup page.

The whole screen is marked for PIR detection (red blocks) as default. Click **Clear All** to delete all the default detection area.

To create a new detection area, press and hold the left mouse button to select the cell or square that you want to start at, then click and drag to select the area that you want to create. Release the mouse to finish.

1. Multiple areas can be created. Each cell or square can be enabled to detect PIR. The same action also applies when deleting an area.
2. Movement outside of the detection areas won't be detected therefore will not trigger recordings or event notifications.
3. Adjust the sensitivity if required, then right-click the mouse to exit.
4. Click **Apply** to save changes made.

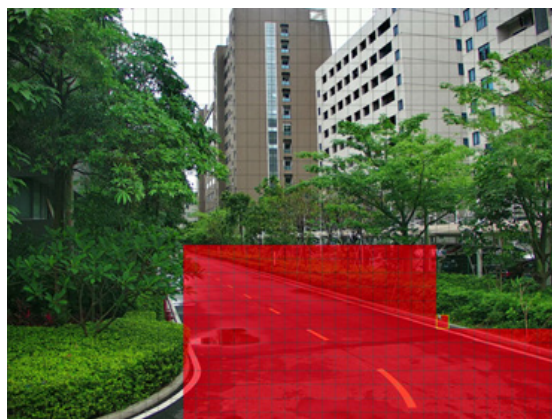
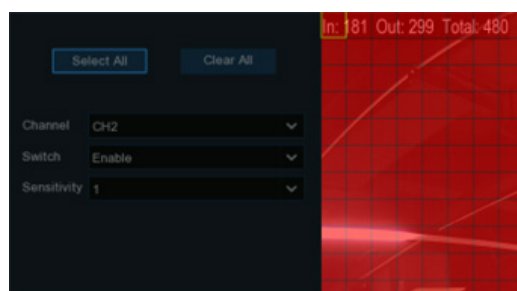

5.1.7.1 - PIR Alarm Settings

Click the **Alarm** button to change options for alarm notifications and more.

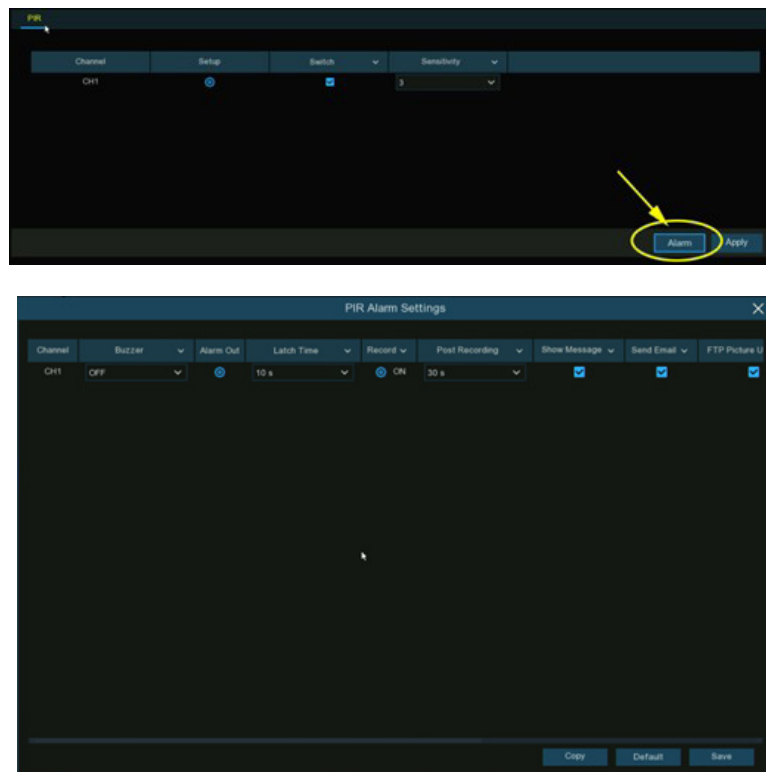

Buzzer: When PIR alarm is detected, you can enable the NVR's buzzer to alert you for a predetermined amount of time. Click the drop-down menu to select a time.

Alarm Out: If your NVR or IP camera supports to connect external replay output devices, the system can send an alert message to the external alarm devices. Click button, to choose the external alarm devices:

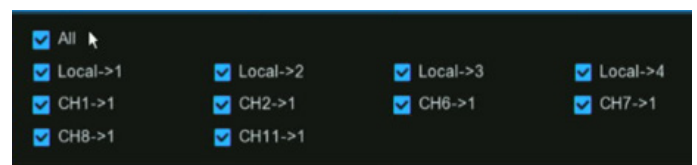

Local: External alarm devices connected to the NVR.

CHx->1: External alarm devices connected to IP cameras.

Latch Time: To configure the external alarm time when the detection is triggered.

Record: This option instructs your NVR to trigger additional cameras to start recording when motion is detected. Click the drop-down arrow to choose all channels to be recorded or not.

Click icon, click the **Record Channel** checkbox to enable recording. Click the checkbox in front of the channel number to select all channels or click on the individual camera number that you want to trigger for recording.

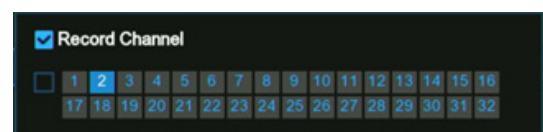

Post Recording: This option instructs your NVR to record for a set time after an event has occurred.

Show Message: When the detection is triggered, the alarm icon  will appear on screen.

Send Email: An email alert will be sent when alarm event is detected. Tick the checkbox if you want to disable this.

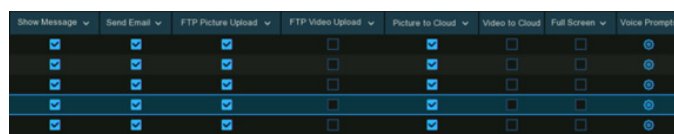

Show Message	Send Email	FTP Picture Upload	FTP Video Upload	Picture to Cloud	Video to Cloud	Full Screen	Voice Prompt
<input checked="" type="checkbox"/>	<input checked="" type="checkbox"/>	<input checked="" type="checkbox"/>	<input type="checkbox"/>	<input checked="" type="checkbox"/>	<input type="checkbox"/>	<input type="checkbox"/>	<input type="checkbox"/>
<input checked="" type="checkbox"/>	<input checked="" type="checkbox"/>	<input checked="" type="checkbox"/>	<input type="checkbox"/>	<input checked="" type="checkbox"/>	<input type="checkbox"/>	<input type="checkbox"/>	<input type="checkbox"/>
<input checked="" type="checkbox"/>	<input checked="" type="checkbox"/>	<input checked="" type="checkbox"/>	<input type="checkbox"/>	<input checked="" type="checkbox"/>	<input type="checkbox"/>	<input type="checkbox"/>	<input type="checkbox"/>
<input checked="" type="checkbox"/>	<input checked="" type="checkbox"/>	<input checked="" type="checkbox"/>	<input type="checkbox"/>	<input checked="" type="checkbox"/>	<input type="checkbox"/>	<input type="checkbox"/>	<input type="checkbox"/>

EN

FTP Picture Upload: Click the checkbox to copy snapshots to your ftp server when the detection is triggered.

FTP Video Upload: Click the checkbox to copy videos to your ftp server when the detection is triggered.

Picture to Cloud: Click the checkbox to copy snapshots to the cloud via Dropbox or Google Drive when the detection is triggered.

Video to Cloud: Click the checkbox to copy videos to the cloud via Dropbox or Google Drive when the detection is triggered.

Full Screen: Click the checkbox to view the camera full-screen in Live View mode when the detection is triggered.

Voice Prompts: If your NVR connects with a speaker, you can select a customized alert voice when the detection is triggered. See how to add customized alert voice on 5.3.9 Voice Prompts.

Default: Click **Default** to revert to default settings.

Copy: Use the **Copy** function to apply all settings to the other connected cameras.

Save: Click **Save** to save settings.

5.1.8 - ROI

Regions of Interest (ROIs) are selected regions for special attention in the video area. This function aims to improve the image encoding quality of the selected regions and reduce the encoding quality outside the selected regions, so as to ensure the image sharpness of the regions for special attention under the condition of constant bitrate. (Note: This function needs to be supported by the camera. It cannot be used with the H.264+ and H.265+ encoding types at the same time.)

Channel	Setup	Stream Type	Region ID	Enable Region	ROI Level	Non-ROI Fps
CH5		Mainstream	1	<input type="checkbox"/>	Lowest	24
CH6		Mainstream	1	<input type="checkbox"/>	Lowest	29
CH7		Mainstream	1	<input type="checkbox"/>	Lowest	29
CH8		Mainstream	1	<input type="checkbox"/>	Lowest	24
CH9		Mainstream	1	<input type="checkbox"/>	Lowest	29
CH10		Mainstream	1	<input type="checkbox"/>	Lowest	29
CH22		Mainstream	1	<input type="checkbox"/>	Highest	14
CH23		Mainstream	1	<input type="checkbox"/>	Highest	19

Stream Type: Select the stream type to set.

Region ID: Select the region ID to be set. You can set at most eight region IDs.

Enable Region: Used to set whether to enable the selected regions: The **Region ID** and **Enable Region** parameters of the selected regions are mutually independent and need to be configured separately.

ROI Level: Used to set the image quality of the selected regions. The higher the quality is, the clearer and the smoother the image is.

Non-ROI Fps: Used to set the frame rate outside the selected regions.

Setup: Click to open the setting page.

Area: Used to set whether to enable ROI selection. The configuration takes effect after you click **Apply**.



5.2 - Record

The recording configuration options are available in the Record and Capture menus accessible from the Main Menu. From here, you can access and change the recording frame rate & resolution and recording schedule for each camera connected. You can also enable and set a schedule for your NVR to take a snapshot each time when an event occurs.

EN

5.2.1 - Encoding Settings

This menu allows you to configure the recording video or network transmission picture quality.

Generally, Mainstream defines the recording video quality which will be saved in the HDD; Substream defines the video quality which is being viewed via remote access, for example web client & CMS/VMS; Mobile Stream defines the video quality which is being viewed via remote access via mobile devices.

5.2.1.1 - Video Encoding

You're able to configure the encode parameters of mainstream, substream and mobile stream accordingly.

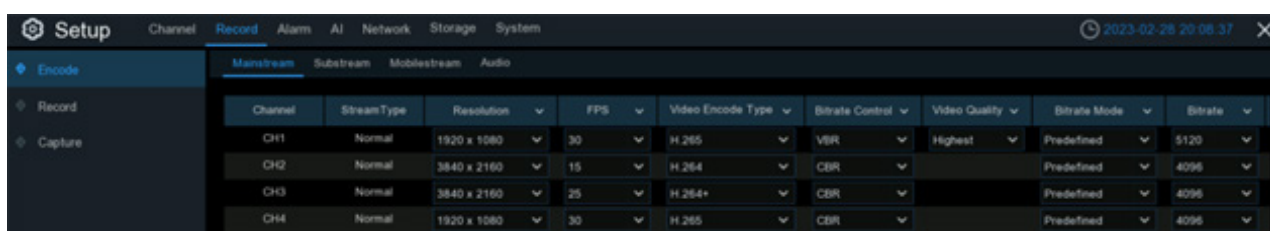

Channel	Stream Type	Resolution	FPS	Video Encode Type	Bitrate Control	Video Quality	Bitrate Mode	Bitrate
CH1	Normal	1920 x 1080	30	H.265	VBR	Highest	Predefined	5120
CH2	Normal	3840 x 2160	15	H.264	CBR		Predefined	4096
CH3	Normal	3840 x 2160	25	H.264+	CBR		Predefined	4096
CH4	Normal	1920 x 1080	30	H.265	CBR		Predefined	4096

Resolution: This parameter defines how large the recorded images will be. The higher the number, the greater the detail available. By default, the recording resolution of the camera is auto-selected by your NVR.

FPS: This parameter defines the number of frames per second the NVR will record. By default, the recording frame rate of the camera is auto-selected by your NVR.

Video Encode Type: It will list the codecs which are supported by the connected camera. The H.265 codec will compress the information more efficiently and provide the best video quality for a given bandwidth between each camera and your NVR, and H.265+ has more compression rate than H.265. The other codec is H.264 which will impact the reliability of the connection between each camera and your NVR due to the higher bandwidth required, and H.264+ has more compression rate than H.264.

Bitrate Control: Select the bitrate level. For a simple scene, such as a gray wall is suitable constant bitrate (CBR). For more complex scene, such as a busy street is suitable variable bitrate (VBR).

Video Quality: Available for VBR only, you can select the recording quality that will define the variable bitrate used, from lowest to highest.

Bitrate Mode: If you want to set the bitrate by yourself, then choose **User-defined** mode. If you want to select the predefined bitrate, choose **Predefined** mode.

Bitrate: This parameter corresponds to the speed of data transfer that the NVR will use to record video. Recordings that are encoded at higher bitrates, will be of better quality. For cameras that monitor medium to high traffic areas, increase the bitrate to add more detail to the camera's image. Just be aware this will increase the bandwidth required. Increase the bitrate in small doses until you are satisfied with the image quality.

Audio: If your camera has built-in microphone or external audio input device, you're able to record the audio streaming together with the video streaming. Click the checkbox to disable or enable. Make sure you have already enabled the Audio streaming in 5.2.1.2. Audio Encoding if you want to record the audio streaming.

FPS	Video Encode Type	Bitrate Control	Video Quality	Bitrate Mode	Bitrate	Audio	I Frame Interval	ETR
30	H.265	VBR	Highest	Predefined	4096	<input checked="" type="checkbox"/>	60	<input type="checkbox"/>
25	H.264	VBR	Highest	Predefined	4096	<input type="checkbox"/>	60	<input type="checkbox"/>
15	H.265	VBR	Highest	Predefined	4096	<input type="checkbox"/>	30	<input type="checkbox"/>
15	H.264	VBR	Highest	User-defined	4096	<input type="checkbox"/>	30	<input type="checkbox"/>
15	H.264	VBR	Lowest	User-defined	4096	<input type="checkbox"/>	30	<input type="checkbox"/>
30	H.265	VBR	Highest	Predefined	4096	<input checked="" type="checkbox"/>	60	<input type="checkbox"/>
30	H.265	VBR	Highest	Predefined	5144	<input checked="" type="checkbox"/>	60	<input type="checkbox"/>
30	H.265	VBR	Highest	Predefined	4096	<input checked="" type="checkbox"/>	60	<input type="checkbox"/>
1	H.264	VBR	Highest	Predefined	4096	<input type="checkbox"/>	60	<input type="checkbox"/>
30	H.265	VBR	Highest	Predefined	8192	<input checked="" type="checkbox"/>	60	<input type="checkbox"/>

I Frame Interval: This configures the number of partial frames that occur between full frames (I-Frames) in the video stream. For example, in a scene where a door opens and a person walks through, only the movements of the door and the person are stored. The stationary background that occurs in the previous partial frames are not encoded. As the I-Frame increases, the number of partial frames also increases. Higher values are only recommended on networks with high reliability, otherwise leave the default selection.

ETR: If your camera supports ETR function, it allows you to set independent video streaming for normal and alarm triggered recording.

Channel	Normal	Alarm
CH1	30 FPS x 0.8K	30 FPS x 0.8K
CH2	30 FPS x 0.8K	30 FPS x 0.8K

For example, you can decrease the frame rate and bitrate to reduce the recording file size in normal recording, and increase the frame rate and bitrate to have clearer and more fluent camera images when an alarm event occurs.

ERT available for mainstream only.

5.2.1.2 - Audio Encoding

If your camera has built-in microphone or external audio input device, you're able to activate the audio stream, define the input/output volume, and select the audio encode type.

Enable: To turn on or turn off the audio streaming.

Output Volume: To choose the audio output volume

Input Volume: To choose the audio input volume

Type: To choose the audio encoding codec.

Channel	Enable	Output Volume	Input Volume	Type
CH1	<input checked="" type="checkbox"/>	5	5	G711A
CH2	<input checked="" type="checkbox"/>	5	5	G711U
CH4	<input checked="" type="checkbox"/>	5	5	G711U
CH6	<input checked="" type="checkbox"/>	5	5	G711A
CH7	<input checked="" type="checkbox"/>	5	5	G711A
CH8	<input checked="" type="checkbox"/>	5	5	G711A
CH11	<input checked="" type="checkbox"/>	5	5	G711A

5.2.2 - Record

This menu allows you to configure the recording parameters for each channel.

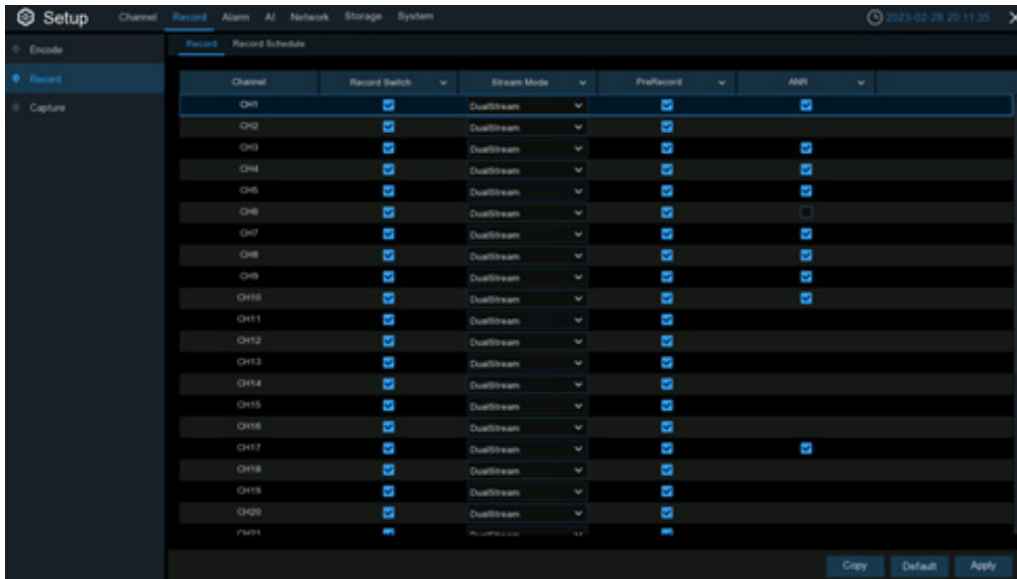

EN

5.2.2.1 - Recording Configuration

Channel	Record Switch	Stream Mode	PreRecord	ANR
CH1	<input checked="" type="checkbox"/>	DualStream	<input checked="" type="checkbox"/>	
CH2	<input checked="" type="checkbox"/>	DualStream	<input checked="" type="checkbox"/>	
CH3	<input checked="" type="checkbox"/>	DualStream	<input checked="" type="checkbox"/>	
CH4	<input checked="" type="checkbox"/>	DualStream	<input checked="" type="checkbox"/>	
CH5	<input checked="" type="checkbox"/>	DualStream	<input checked="" type="checkbox"/>	
CH6	<input checked="" type="checkbox"/>	DualStream	<input checked="" type="checkbox"/>	
CH7	<input checked="" type="checkbox"/>	DualStream	<input checked="" type="checkbox"/>	<input checked="" type="checkbox"/>
CH8	<input checked="" type="checkbox"/>	DualStream	<input checked="" type="checkbox"/>	<input checked="" type="checkbox"/>
CH9	<input checked="" type="checkbox"/>	DualStream	<input checked="" type="checkbox"/>	

Record Switch: Check to enable the recording in this channel.

Stream Mode: By default, your NVR will record both Mainstream and Substream video (known as **Dual-stream**). **Mainstream** (high quality) video is used for playback when using your NVR directly, and Substream (reduced quality) is used for remote playback on your mobile device. If remote playback is not required, you can select Mainstream recording only to save your storage space.

Prerecord: Allows your NVR to record for several seconds before an event occurs. It's recommended to leave this enabled.

ANR: Generally, videos are stored in the NVR when network connection is normal between the NVR and cameras. With ANR (Automatic Network Replenishment) function, the camera would start continuous recording and store videos in SD card instead when the connection is lost. Once the network is restored, the video recordings will be sent back to NVR's storage. It is recommended to enable ANR if your camera supports this function.

5.2.2.2 - Recording Schedule

This menu allows you to specify when the NVR records video and defines the recording mode for each channel. The recording schedule lets you set up a schedule like, daily and hourly by normal (continuous) recording, motion recording, I/O alarm recording & PIR recording (if your camera supports).

By default, the NVR is set to constantly record in 24-hour 7 days. The schedule can be changed to suit your needs and each camera can have a different schedule if needed. The schedule is color coded to represent the event type.

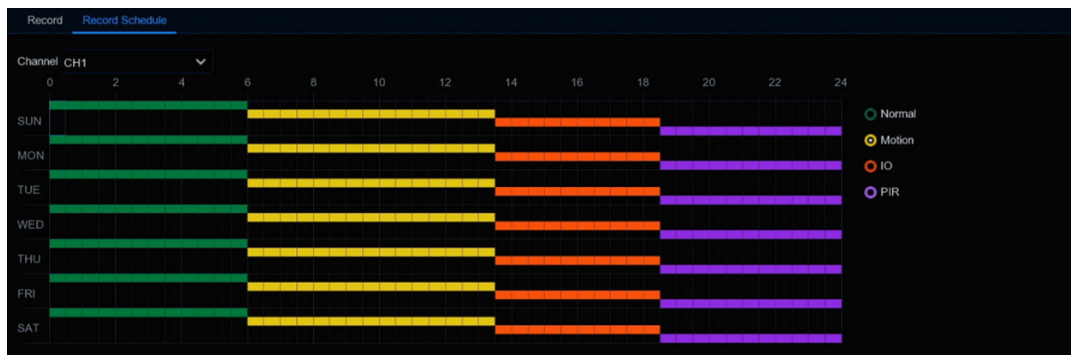

1. Choose a **Channel** you want to set.
2. Click on the mode radio button to choose one of the recording modes:
 - **Normal:** Your NVR will constantly record for a set period. Time slot will be marked green color for normal recording.
 - **Motion:** Your NVR will only record when motion is detected. Time slot will be marked yellow color for motion detection recording.
 - **IO:** Your NVR will only record when external sensor is triggered. Time slot will be marked red color for sensor triggered recording.
 - **PIR:** Your NVR will only record when PIR detection occurs. Time slot will be marked purple color for PIR detection recording.
3. Drag the cursor to mark the slots on the time slots.
4. The set recording schedule is valid only for one channel. If you want to use the same recording schedule for other channels, use **Copy** function.
5. If a time slot marked black means that there will be no recording at the time period.
6. Click **Apply** to save your settings.

5.2.3 - Capture Images

You can enable and set a schedule for your NVR to take a snapshot each time an event occurs. It helps to find alarm events quickly and can also be used for timelapse photography.

EN

NOTE: The maximum resolution of captured image is 1920x1080

5.2.3.1 - Capture Configuration

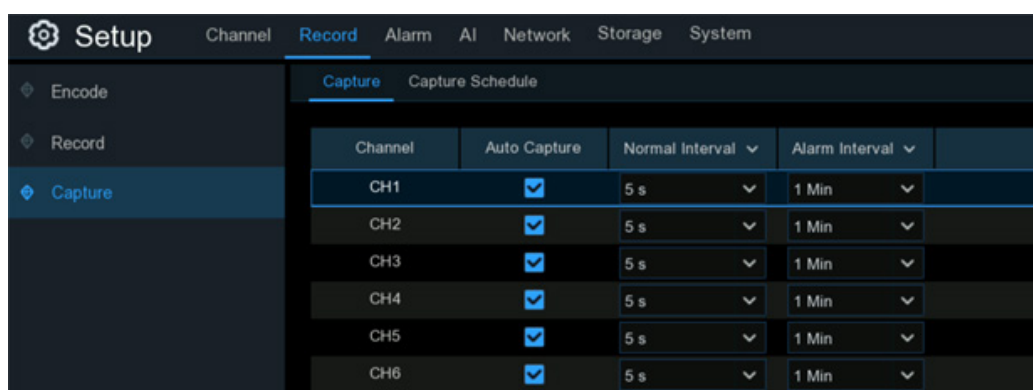

Channel	Auto Capture	Normal Interval	Alarm Interval
CH1	<input checked="" type="checkbox"/>	5 s	1 Min
CH2	<input checked="" type="checkbox"/>	5 s	1 Min
CH3	<input checked="" type="checkbox"/>	5 s	1 Min
CH4	<input checked="" type="checkbox"/>	5 s	1 Min
CH5	<input checked="" type="checkbox"/>	5 s	1 Min
CH6	<input checked="" type="checkbox"/>	5 s	1 Min

Auto Capture: When enabled, your NVR will take a snapshot each time an event occurs.

Normal Interval: The length of time that must elapse before a snapshot is taken. For example, when setting a **Normal** capture schedule, a snapshot is taken every 5 seconds using the default selection. Adjust accordingly.

Alarm Interval: When setting alarm (Motion, IO or PIR) capture schedule, a snapshot is taken each time when alarm is detected, according to the interval selected. Adjust accordingly.

5.2.3.2 - Capture Configuration

You must create a capture schedule so your NVR can take snapshots when an event has occurred or if you want to take snapshots using a time interval (every 5 seconds, for example).

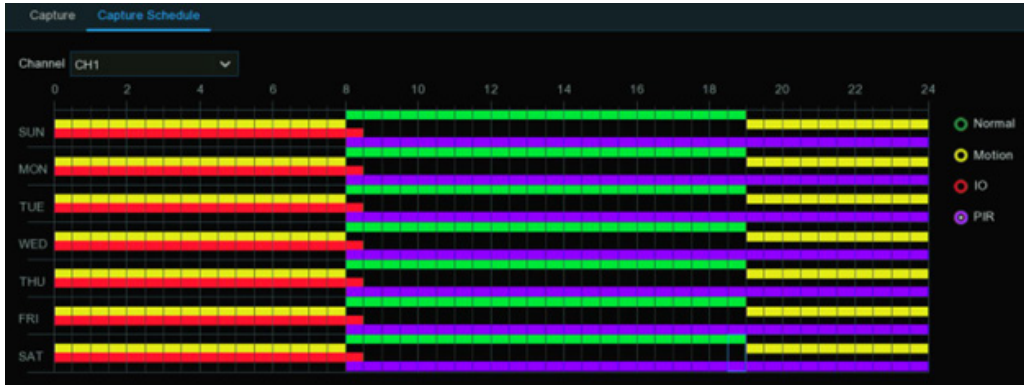

1. Choose a **Channel** you want to set.
2. Click on the mode radio button to choose one of the capture modes:
 - **Normal:** A snapshot is taken according to the normal interval setting selected (every 5 seconds, for example). Time slot will be marked green color for normal capture.
 - **Motion:** A snapshot is taken during a motion alarm. Time slot will be marked yellow color for motion detection capture.
 - **IO:** Your NVR will only record when external sensor is triggered. Time slot will be marked red color for normal recording.
 - **PIR:** Your NVR will only record when PIR detection occurs. Time slot will be marked purple color for normal recording.
3. Drag the cursor to mark the slots on the time table.
4. The set capture schedule is valid only for one channel. If you want to use the same schedule for other channels, use **Copy** function.
5. If a time slot marked black means that there will be no capture at the time period.
6. Click **Apply** to save your settings.

5.3 - Alarm Settings

In this section, you can configure the alarm actions when event occurs.

EN

5.3.1 - Motion Alarm

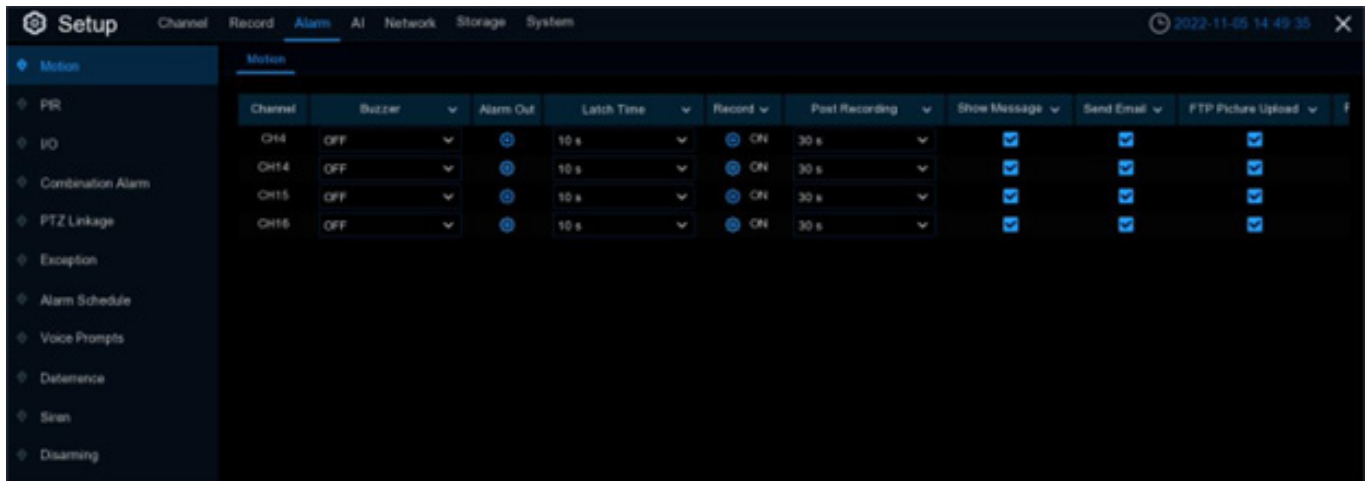

Buzzer: When motion is detected, you can enable the NVR's buzzer to alert you for a predetermined amount of time. Click the drop-down menu to select a time.

Alarm Out: If your NVR or IP camera supports to connect external replay output devices, the system can send an alert message to the external alarm devices. Click button, to choose the external alarm devices:

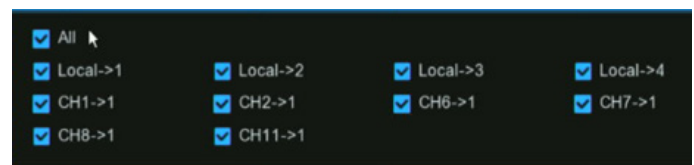

Local: External alarm devices connected to the NVR.

CHx->1: External alarm devices connected to IP cameras.

Latch Time: To configure the external alarm time when the detection is triggered.

Record: This option instructs your NVR to trigger additional cameras to start recording when motion is detected. Click the drop-down arrow to choose all channels to be recorded or not.

Click icon, click the **Record Channel** checkbox to enable recording. Click the checkbox in front of the channel number to select all channels or click on the individual camera number that you want to trigger for recording.

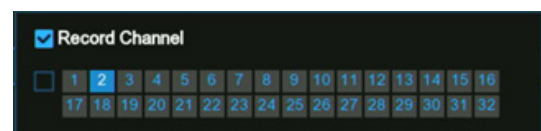

Post Recording: This option instructs your NVR to record for a set time after an event has occurred. For most instances, the default selection will be suitable, however, you can change this if you wish.

Show Message: When the detection is triggered, the alarm icon will appear on screen.

Send Email: An email alert will be sent when alarm event is detected. Tick the checkbox if you want to disable this.

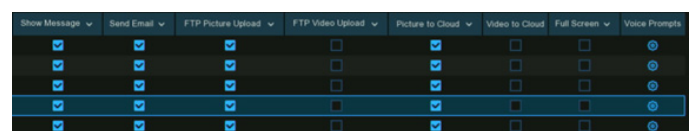

FTP Picture Upload: Click the checkbox to copy snapshots to your ftp server when the detection is triggered.

FTP Video Upload: Click the checkbox to copy videos to your ftp server when the detection is triggered.

Picture to Cloud: Click the checkbox to copy snapshots to the cloud via Dropbox or Google Drive when the detection is triggered.

Video to Cloud: Click the checkbox to copy videos to the cloud via Dropbox or Google Drive when the detection is triggered.

Full Screen: Click the checkbox to view the camera full-screen in Live View mode when the detection is triggered.

Voice Prompts: If your NVR connects with a speaker, you can select a customized alert voice when the detection is triggered. See how to add customized alert voice on 5.3.9 Voice Prompts.

Motion: To configure the motion detection. See more on 5.1.6. Motion Detection.



Default: Click **Default** to revert to default settings.

Copy: Use the **Copy** function to apply all settings to the other connected cameras.

Apply: Click **Apply** to save settings.

5.3.2 - PIR Alarm

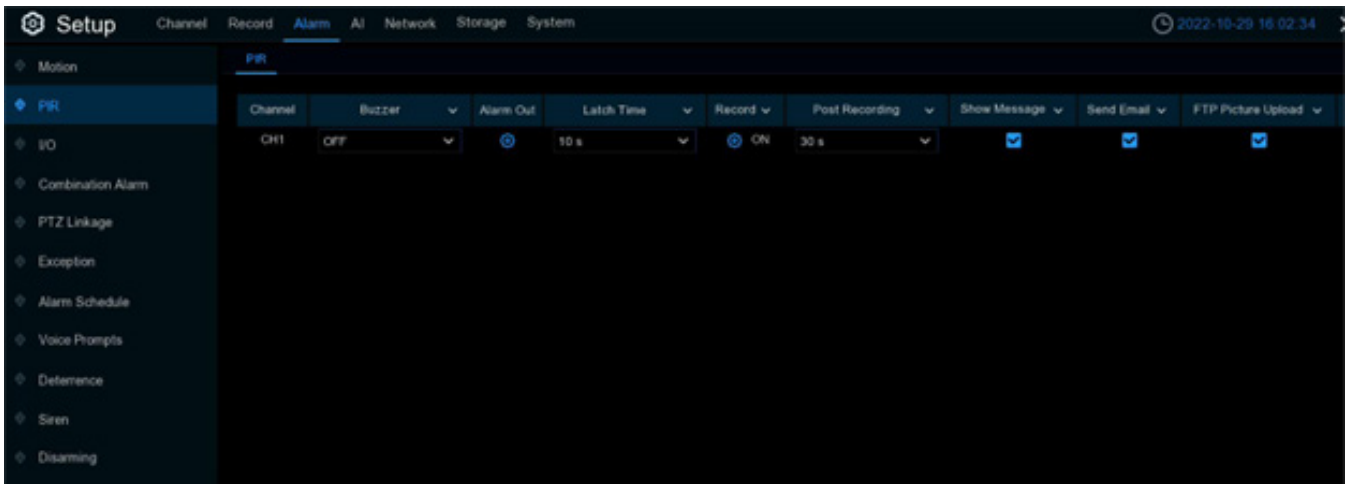

Buzzer: When PIR is detected, you can enable the NVR’s buzzer to alert you for a predetermined amount of time. Click the drop-down menu to select a time.

Alarm Out: If your NVR or IP camera supports to connect external replay output devices, the system can send an alert message to the external alarm devices. Click button, to choose the external alarm devices:

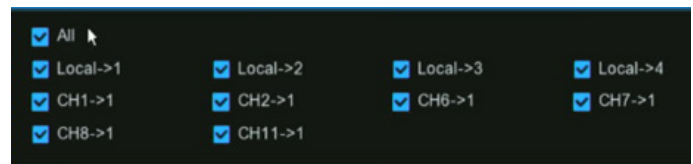

Local: External alarm devices connected to the NVR.

CHx->1: External alarm devices connected to IP cameras.

Latch Time: To configure the external alarm time when the detection is triggered.

Record: This option instructs your NVR to trigger additional cameras to start recording when PIR is detected. Click the drop-down arrow to choose all channels to be recorded or not.

Click icon, click the **Record Channel** checkbox to enable recording. Click the checkbox in front of the channel number to select all channels or click on the individual camera number that you want to trigger for recording.

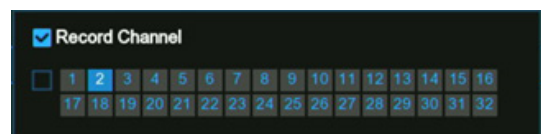

Post Recording: This option instructs your NVR to record for a set time after an event has occurred. For most instances, the default selection will be suitable, however, you can change this if you wish.

Show Message: When the detection is triggered, the alarm icon will appear on screen.

Send Email: An email alert will be sent when alarm event is detected. Tick the checkbox if you want to disable this.

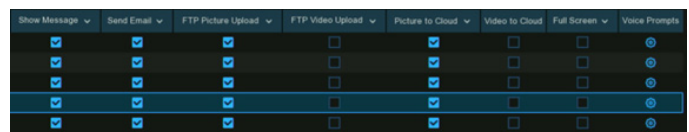

FTP Picture Upload: Click the checkbox to copy snapshots to your ftp server when the detection is triggered.

FTP Video Upload: Click the checkbox to copy videos to your ftp server when the detection is triggered.

Picture to Cloud: Click the checkbox to copy snapshots to the cloud via Dropbox or Google Drive when the detection is triggered.

Video to Cloud: Click the checkbox to copy videos to the cloud via Dropbox or Google Drive when the detection is triggered.

Full Screen: Click the checkbox to view the camera full-screen in Live View mode when the detection is triggered.

Voice Prompts: If your NVR connects with a speaker, you can select a customized alert voice when the detection is triggered. See how to add customized alert voice on 5.3.9 Voice Prompts.

PIR Detection: To configure the PIR detection. See more on 5.1.7. PIR.

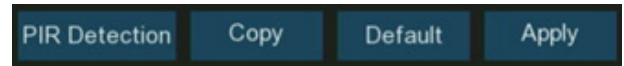

Default: Click **Default** to revert to default settings.

Copy: Use the **Copy** function to apply all settings to the other connected cameras.

Apply: Click **Apply** to save settings.

5.3.3 - I/O Alarm

If your NVR or the connected camera has alarm input function, you will need to configure the settings to make the connected sensor works probably.

EN

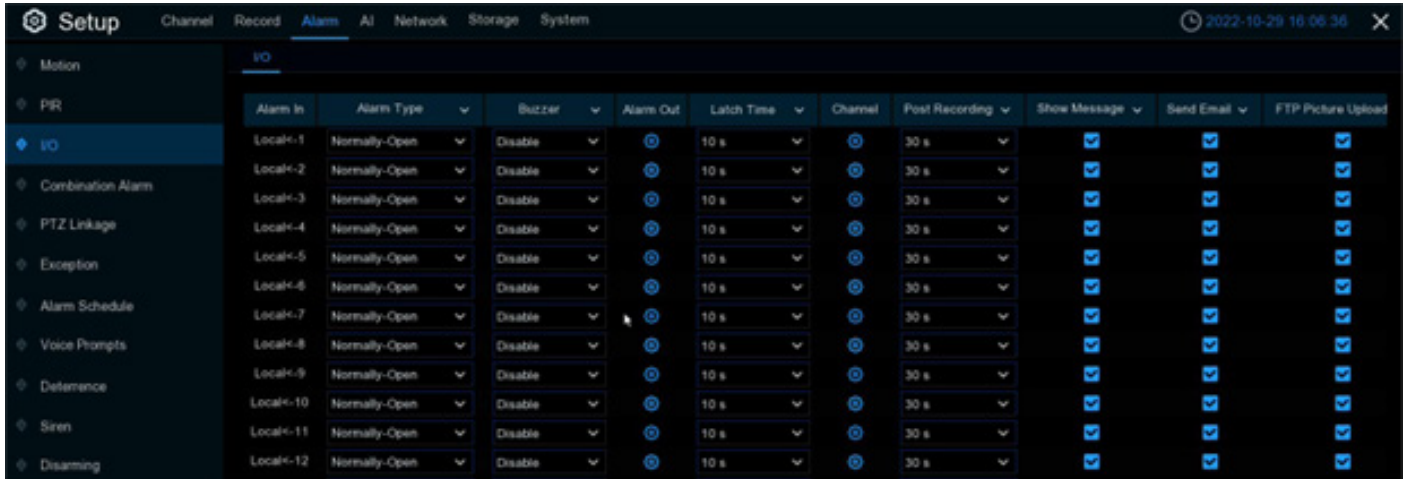

Alarm In: Alarm input channel

- **Local:** Alarm input devices connected to NVR
- **CHx-> 1:** Alarm input devices connected to IP camera.

Alarm Type: There are 3 types for your choice: Normally Open, Normally Closed, and OFF. Choose the one which is well-matched with your sensor, or choose OFF to close the sensor trigger function.

Buzzer: When IO Alarm is detected, you can enable the NVR’s buzzer to alert you for a predetermined amount of time. Click the drop-down menu to select a time.

Alarm Out: If your NVR or IP camera supports to connect external replay output devices, the system can send an alert message to the external alarm devices. Click button, to choose the external alarm devices:

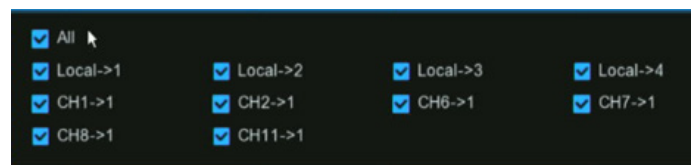

Local: External alarm devices connected to the NVR.

CHx->1: External alarm devices connected to IP cameras.

Latch Time: To configure the external alarm time when the detection is triggered.

Record: This option instructs your NVR to trigger additional cameras to start recording when motion is detected. Click the drop-down arrow to choose all channels to be recorded or not.

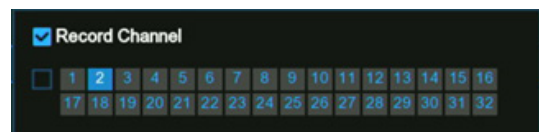

Click icon, click the **Record Channel** checkbox to enable recording. Click the checkbox in front of the channel number to select all channels or click on the individual camera number that you want to trigger for recording.

Post Recording: This option instructs your NVR to record for a set time after an event has occurred. For most instances, the default selection will be suitable, however, you can change this if you wish.

Show Message: When the detection is triggered, the alarm icon 📢 will appear on screen.

Send Email: An email alert will be sent when alarm event is detected. Tick the checkbox if you want to disable this.

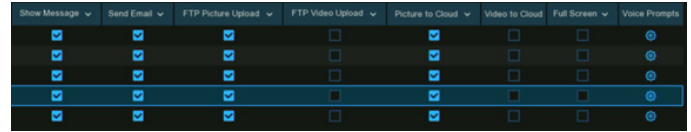

FTP Picture Upload: Click the checkbox to copy snapshots to your ftp server when the detection is triggered.

FTP Video Upload: Click the checkbox to copy videos to your ftp server when the detection is triggered.

Picture to Cloud: Click the checkbox to copy snapshots to the cloud via Dropbox or Google Drive when the detection is triggered.

Video to Cloud: Click the checkbox to copy videos to the cloud via Dropbox or Google Drive when the detection is triggered.

Full Screen: Click the checkbox to view the camera full-screen in Live View mode when the detection is triggered.

Voice Prompts: If your NVR connects with a speaker, you can select a customized alert voice when the detection is triggered. See how to add customized alert voice on 5.3.9 Voice Prompts.

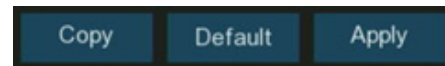

Default: Click **Default** to revert to default settings.

Copy: Use the **Copy** function to apply all settings to the other connected cameras.

Apply: Click **Apply** to save settings.

5.3.4 - Combined Alarm

Combined Alarm function allows to set a combination of 2 alarm types. The NVR will only alert when both the alarm types in the combination are triggered in the same time. This would help to minimize the false alarm rate.

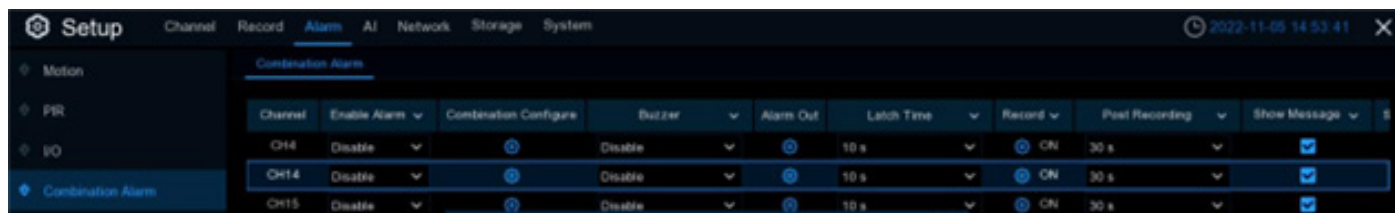

Enable Alarm: To enable or disable combined alarm. Click the Configuration button on a channel to choose the alarm combination. You're able to choose 2 kinds of alarm type from NVR and/or IP camera.

NOTE: If the combined alarm is enabled in a channel, all of the individual alarm functions you had set in that channel will be disabled. The individual alarm functions will be restored if the combined alarm function is disabled.

Buzzer: When the detection is triggered, you can enable the NVR's buzzer to alert you for a predetermined amount of time. Click the drop-down menu to select a time.

Alarm Out: If your NVR or IP camera supports to connect external replay output devices, the system can send an alert message to the external alarm devices. Click button, to choose the external alarm devices:

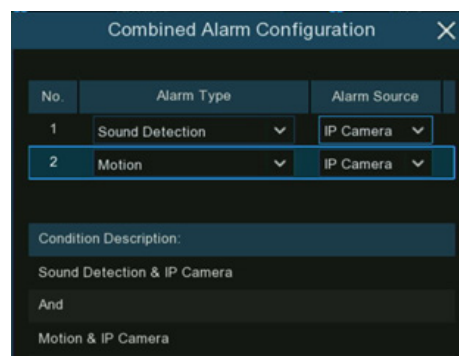

Local: External alarm devices connected to the NVR.

CHx->1: External alarm devices connected to IP cameras.

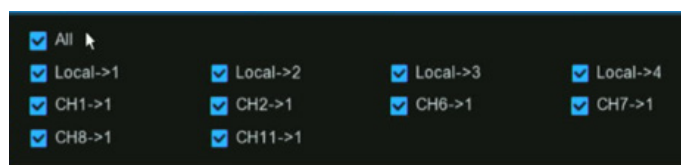

Latch Time: To configure the external alarm time when the detection is triggered.

Record: This option instructs your NVR to trigger additional cameras to start recording when PIR is detected. Click the drop-down arrow to choose all channels to be recorded or not.

Click icon, click the **Record Channel** checkbox to enable recording. Click the checkbox in front of the channel number to select all channels or click on the individual camera number that you want to trigger for recording.

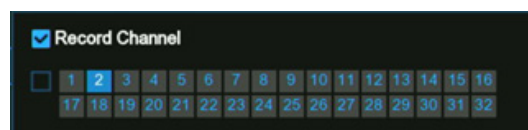

Post Recording: This option instructs your NVR to record for a set time after an event has occurred.

Show Message: When the detection is triggered, the alarm icons will appear on screen.

Send Email: An email alert will be sent when alarm event is detected. Tick the checkbox if you want to disable this.

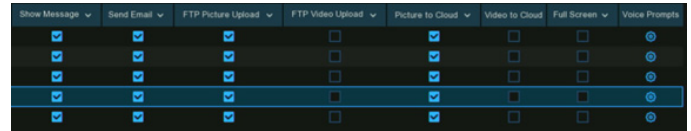

FTP Picture Upload: Click the checkbox to copy snapshots to your ftp server when the detection is triggered.

FTP Video Upload: Click the checkbox to copy videos to your ftp server when the detection is triggered.

Picture to Cloud: Click the checkbox to copy snapshots to the cloud via Dropbox or Google Drive when the detection is triggered.

Video to Cloud: Click the checkbox to copy videos to the cloud via Dropbox or Google Drive when the detection is triggered.

Full Screen: Click the checkbox to view the camera full-screen in Live View mode when the detection is triggered.

Voice Prompts: If your NVR connects with a speaker, you can select a customized alert voice when the detection is triggered. See how to add customized alert voice on 5.3.9 Voice Prompts.

Default: Click Default to revert to default settings.

Copy: Use the Copy function to apply all settings to the other connected cameras.

Apply: Click Apply to save settings.

5.3.5 - PTZ Linkage

If there are one or more PTZ cameras connected to your NVR, you are able to set the actions of PTZ cameras when motion event, I/O sensor alarm and/or PIR alarm occurs, to move your PTZ cameras focusing on a selected preset position.

Switch: Tick the checkbox to enable the PTZ linkage function.

Alarm: Click button to choose the alarm source to enable the PTZ linkage function when the selected alarm occurs.

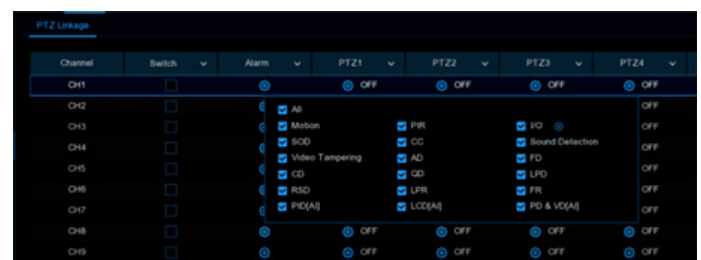

PTZ: For each channel, there are maximum 4 PTZ preset point positions available for you to set for the PTZ linkage function.

- Click button on PTZ 1~4, tick the check point to enable, and then select the channel of connected PTZ camera and choose a preset point.

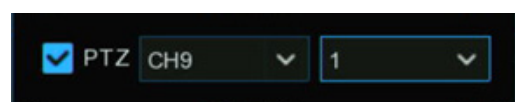

5.3.6 - Exception Alarm

The system allows to set the abnormal events that you want the NVR to inform you.

EN

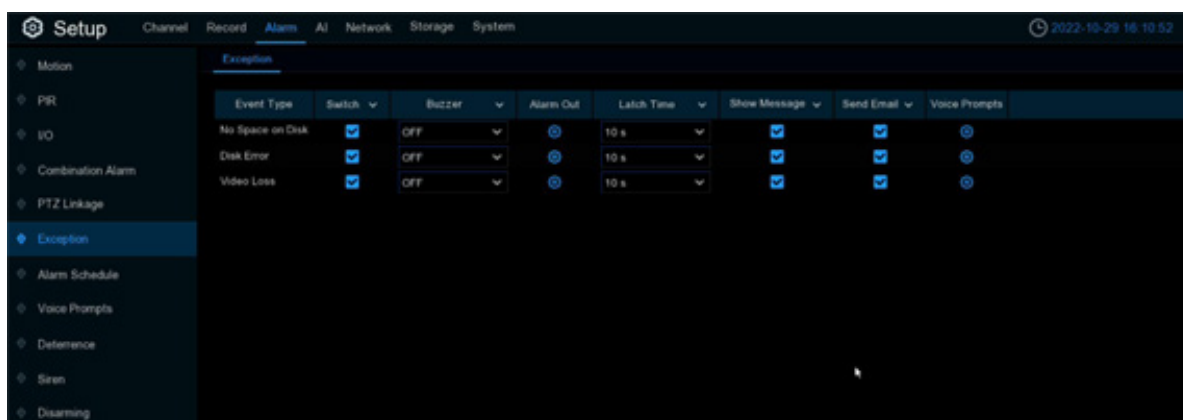

Event Type: There are three event types that your NVR will detect as an exception:

- **No Space on Disk:** no space left on the hard drive.
- **Disk Error:** a hard drive error.
- **Video Loss:** one or more channels have lost the connection.

Buzzer: When the detection is triggered, you can enable the NVR's buzzer to alert you for a predetermined amount of time. Click the drop-down menu to select a time.

Alarm Out: If your NVR or IP camera supports to connect external replay output devices, the system can send an alert message to the external alarm devices. Click button, to choose the external alarm devices:

Local: External alarm devices connected to the NVR.

CHx->1: External alarm devices connected to IP cameras.

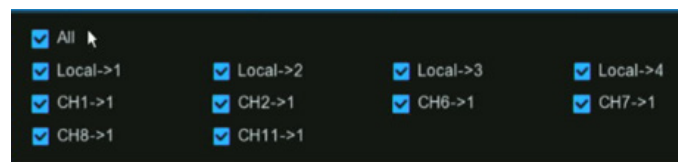

Latch Time: To configure the external alarm time when the detection is triggered.

Show Message: Check the box to display a message on the screen when No Space on Disk, Disk Error, or Video Loss event happens.

Send Email: Click the checkbox to enable your NVR to send an email alert when the detection is triggered.

Voice Prompts: If your NVR connects with a speaker, you can select a customized alert voice when the detection is triggered. See how to add customized alert voice on 5.3.9 Voice Prompts.

5.3.7 - Alarm Schedule

You are able to set the schedule individually for Alarm out, Push Notification, FTP Upload, Cloud Upload, Buzzer and Voice Prompts. The schedule is set to enable 24 hours 7 days, you can change accordingly.

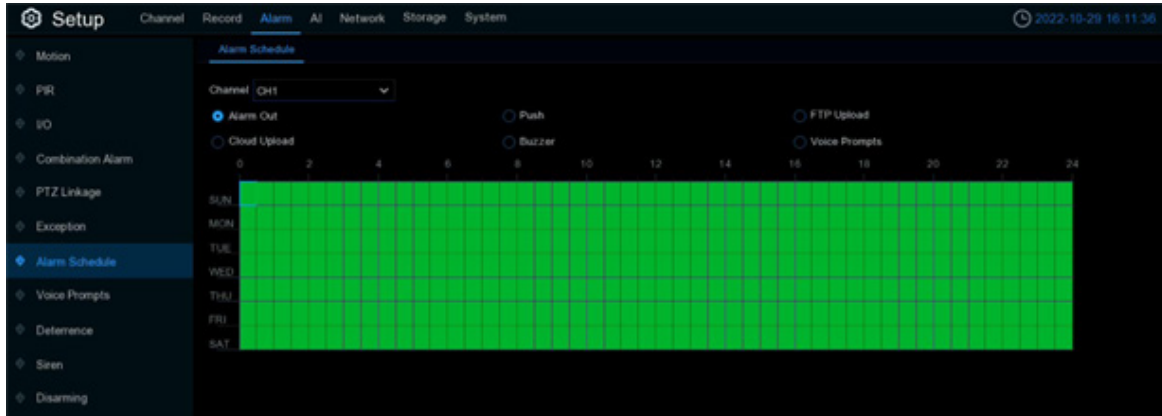

1. Select the channel you want to set the schedule.
2. Click on the radio button of the event you want to set.
3. Drag the cursor to mark the slots. The green blocks in the time slots will be active for alarm.
4. The schedule is valid only for the selected channel each time when you set. If you want to use the same schedule for other channels, use **Copy** function.
5. Click **Save** to save your settings.

5.3.8 - Voice Prompts

If your NVR or IP camera supports the voice prompt function and has a built-in or external speaker, you can set a customized alert voice when an alarm event occurs.

EN

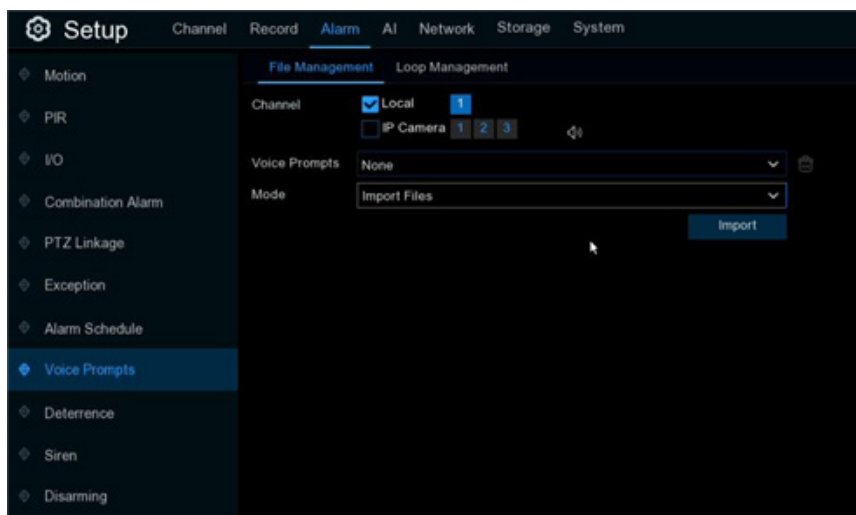

5.3.8.1 - Voice File Management

You can create and delete voice files in this section.

5.3.8.1.1 - Creating Voice Files

The system provides 3 different methods to create customized voices:

- **Import Files**
- **Local Conversion**
- **Internet Server Conversion**

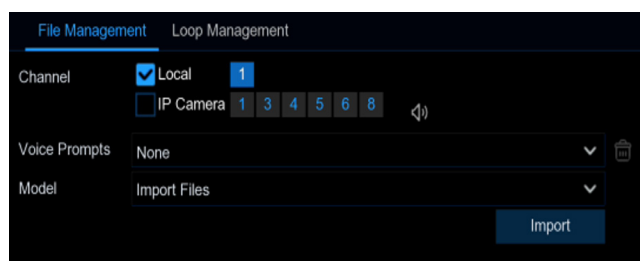

Import Files: Supports to import MP3, WMA and WAV files from USB flash drive and/or web page.

Choose Import Files model, and then click the Import button, and choose the audio file from your USB memory. It is allowed to add only 1 file at a time. You can add multiple files at a time in the web page.

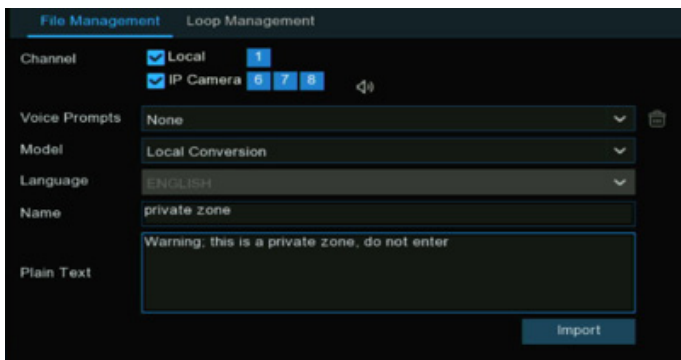

Local Conversion: The system supports to convert your plain texts into an audio file by local algorithm.

Choose Local Conversion model, and then input the name of the file & plain text. Click Import button, the system will convert the text you input into a voice file and save to the NVR storage.

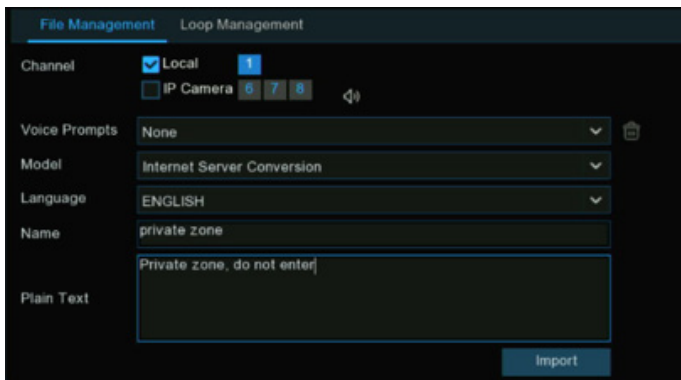

Internet Server Conversion: The system supports to convert your plain texts into a multi-language audio file by internet server.

Choose Local Conversion model and language you want to speak, and then input the name of the file & plain text. Click Import button, the system will convert the text you input into a voice file and save to the NVR storage.

It is recommended to operate with webpage for multi-language input.

5.3.8.1.2 - Audition Voice

After creating your voice files, you are able to audition them with your NVR and/or IP camera's speaker.

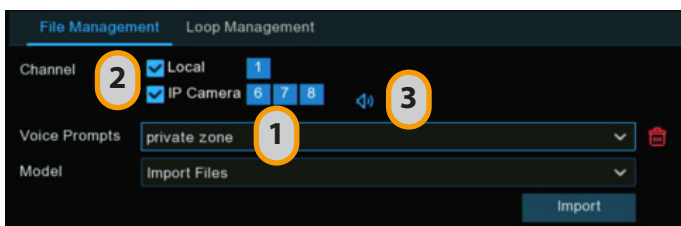

- 1 – Select a voice file firstly.
- 2 – Choose the voice playing device. **Local** indicates the NVR audio output device, **IP Camera** indicates the speaker or audio output device in the IP camera.
- 3 – Click the play button to audition.

5.3.8.1.3 - Delete Voice Files

If you want to delete the voice file(s), please operate as below:

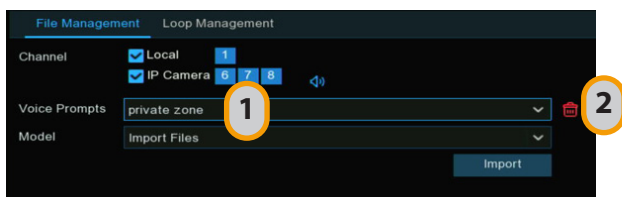





- 1 – Select a voice file first.
- 2 – Click the delete button to delete the file.
3. Repeat step 1 and 2 to delete another file.

5.3.8.2 - Loop Management

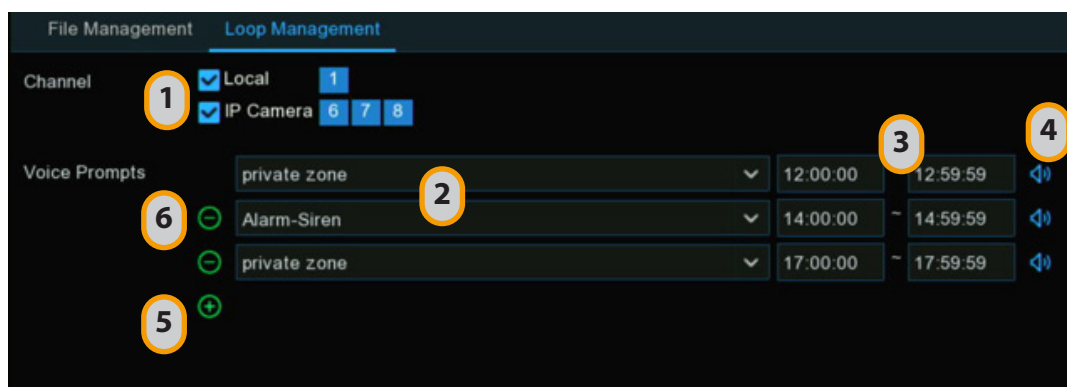
The system allows to play a continuous loop of the voices in a certain period of time.

EN



- 1 – Select the play device.
- 2 – Choose a voice file.
- 3 – Set the time period.
- 4 – Click play button  to start the audition.
- 5 – Click add button  to add another loop playlist. Maximum 12 playlists can be set.
- 6 – If you want to delete the loop playlist, click the delete button .
- 7 – Click **Apply** to save your settings.

 **NOTE:** The period of time in each playlist cannot be overlapped to others.

5.3.9 - Deterrence

This menu allows you to configure the action of built-in white lights (also known as “spotlights”) and speaker of the deterrence cameras when an alarm event is detected.

Channel	Setup	Sensitivity	Light	Schedule	Duration	Warning Light	Schedule	Warning Light Duration
CH1	⊙	1	<input type="checkbox"/>	⊙	30			
CH2	⊙	1	<input type="checkbox"/>	⊙	30			
CH3	⊙	1	<input type="checkbox"/>	⊙	30			
CH4	⊙	1	<input type="checkbox"/>	⊙	30			
CH5	⊙	1	<input type="checkbox"/>	⊙	30			
CH6	⊙	1	<input type="checkbox"/>	⊙	30			
CH7	⊙	1	<input type="checkbox"/>	⊙	30			
CH8	⊙	1	<input type="checkbox"/>	⊙	30			
CH9	⊙	1	<input type="checkbox"/>	⊙	30			
CH10	⊙	1	<input type="checkbox"/>	⊙	60			
CH11	⊙	1	<input type="checkbox"/>	⊙	30			
CH12	⊙	1	<input type="checkbox"/>	⊙	30			
CH13	⊙	1	<input type="checkbox"/>	⊙	30			
CH14	⊙	1	<input type="checkbox"/>	⊙	30	<input type="checkbox"/>	⊙	60
CH15	⊙	1	<input type="checkbox"/>	⊙	60	<input type="checkbox"/>	⊙	60

Setup: Click button to enter configuration page.

- **Light:** Click the drop-down menu to enable the camera’s white light.
- **Light Brightness:** For some certain cameras, you can adjust the flood light value. The greater the value, the brighter the light will be.
- **Duration:** This lets you change the length of time the white light will remain lit when alarm is detected. Adjust accordingly.
- **Color Image:** If enabled, the night vision images will be turned to be colorful. If disabled, the night version images will remain black & white.
- **Deterrence Mode:** Click the drop-down menu to select a solid light (**Warning Light**) or a flashing light (**Strobe Light**). When picking **Strobe Light**, you can select a low, medium or high **Strobe Frequency** setting.
- **Warning Light:** Click the drop-down menu to enable the camera’s warning light.
- **Warning Light Duration:** This lets you change the length of time the warning light will remain lit when alarm is detected. Adjust accordingly.

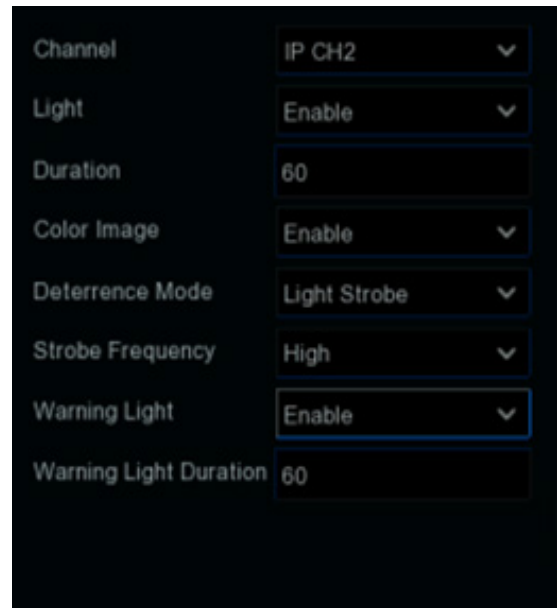

Schedule: Click button to configure the deterrence schedule:

- When the camera is connected to the NVR with client port, the schedule interface might be displayed as adjacent image

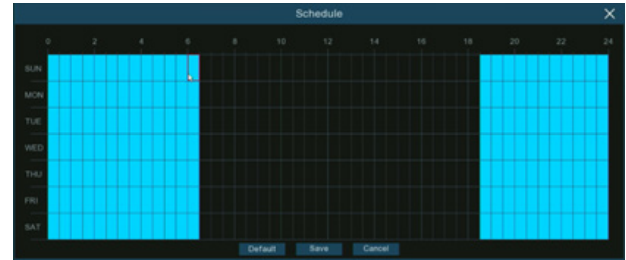

EN

By default, the white lights will not trigger between and 04:30 p.m. and 06:30 a.m., however you can change this according to your needs.

Each square represents 30 minutes. Using the mouse, click on a particular square to change or click and drag the mouse over the squares corresponding to your desired period. Squares in blue color are active for deterrence.

Click **Save** to save changes made. Right-click the mouse to exit.

- When the camera is connected to the NVR with web port, the schedule interface might be displayed as adjacent image

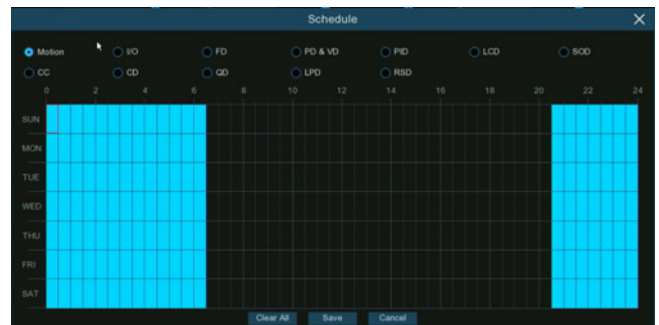

All supported alarm types are listed, you're able to configure the schedule for each individual alarm type. Click the checkbox of the alarm type you want to set, and the set the schedule accordingly. Click **Save** to save changes made. Right-click the mouse to exit.

5.3.10 - Siren

If the camera connected to the device has a built-in speaker, you can set the siren-related parameters in this module.

Channel: Select the switch channel.

Enable: Used to set whether to enable the siren function.

Siren Type: Used to select the siren audio file. By default two audio files are provided. You can also import three customized audio files (of PCM format or WAV format). The audio sample rate of the imported file cannot exceed 8000 Hz, and the file size cannot exceed 256 KB. After you select a customized audio file to be imported, a **Delete** button appears on the right of the file, and you can click the **Delete** button to delete the audio file. (Note: This function is supported by some IP cameras only.)

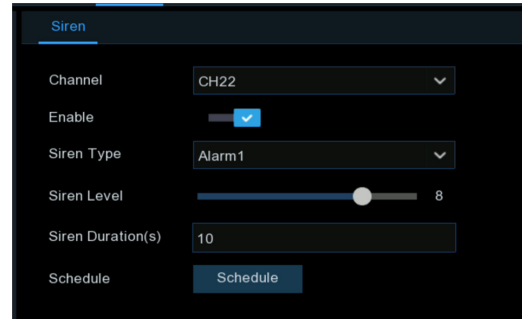

File Name: If you select **User-defined** for **Siren Type**, you can enter the file name and click the **Import** button on the right to import the customized audio file from a USB flash disk.

Siren Level: Used to set the siren volume level, which ranges from 1 to 10. The higher the level is, the louder the volume is.

Siren Duration(s): Used to set the siren duration. You can adjust the value between 5 to 180 seconds.

Schedule: If the IP camera is connected to the NVR via the HTTP port, you can click the **Schedule** button to open the setting page.

If a channel is selected in the schedule, it indicates that the channel can trigger siren alarms during the corresponding period.

You can set the siren linkage alarm and effective time of a function by selecting the corresponding function sub-tab and switch.

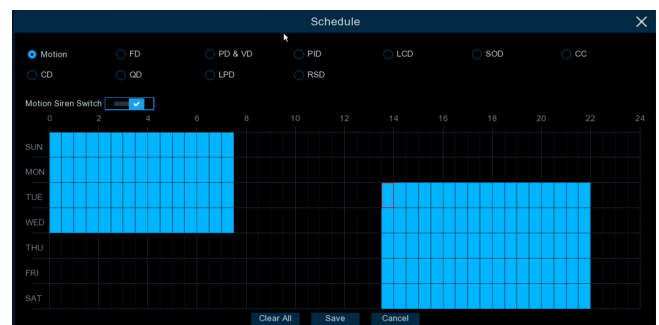

Clear All: Click this button to clear the selected status on all sub-tabs.

5.3.11 - Disarming

After the one-click disarming function is enabled, you can cancel the response of the device to various alarms. On this page you can set the relevant parameters including the disarming switch, channel, type, and schedule. Note: The Exception system alarms are not controlled by one-click disarming.

EN

Disarming: Used to set whether to enable the one-click disarming function.

Disarm Alarm Linkage Action: Used to set the alarm linkage types to be disarmed.

All: Select or clear all the types.

Buzzer: Used to set whether to enable the buzzer. When the one-click disarming function is enabled, you can select this option to disable the buzzer.

Alarm Out: Used to set whether to enable external alarm output. When the one-click disarming function is enabled, you can select this option to disable the external alarm device when an alarm is triggered.

Show Message: Used to set whether to display messages. When the one-click disarming function is enabled, you can select this option to not display the alarm messages when motion is detected on the preview page.

Send Email: Used to set whether to send emails. When the one-click disarming function is enabled, you can select this option to make the NVR not automatically send an email when an alarm is triggered.

Full Screen: Used to set whether to display in full screen. When the one-click disarming function is enabled, you can select this option to make the channel configured with full-screen mode not enter full screen mode on the preview screen when the channel triggers an alarm.

Voice Prompts: Used to set whether to enable voice prompts. When the one-click disarming function is enabled, you can select this option to disable voice prompts when a channel configured with voice prompts triggers an alarm.

Channel: Select the channels to be disarmed. Schedule: Click the Setup button to open the schedule setting page.

If a channel is selected in the schedule, it indicates that the channel is in disarming status within the corresponding period.

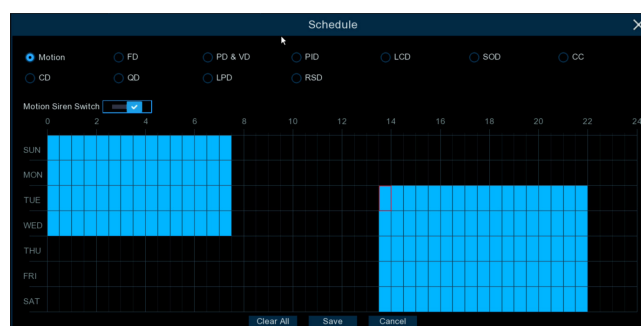
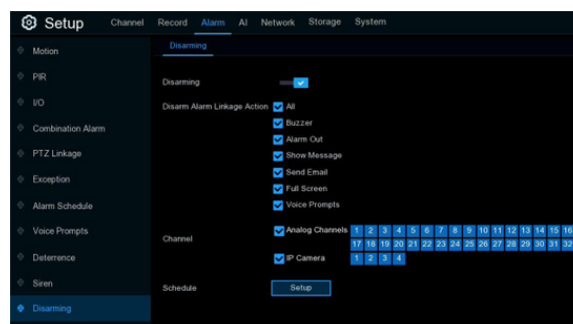

5.4 - AI

Artificial Intelligence (AI) is an advanced function for the system to detect various of alarm events based on face detection, human detection and vehicle detection technology with AI powered IP cameras and take actions accordingly. You will see this section if your NVR has AI capacity.

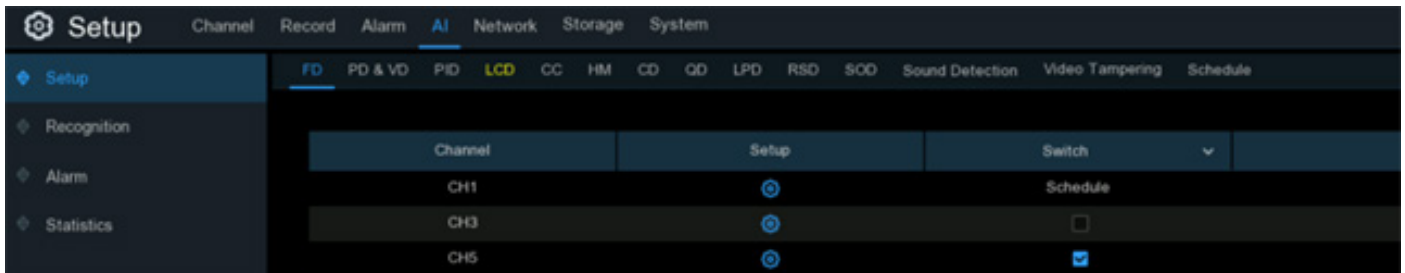

5.4.1 - AI Setup

In this section, you will be able to activate the AI functions and let them work properly according to your requirements.

NOTE: The detection functions, including Face Detection, Human & Vehicle Detection, Perimeter Intrusion Detection, Line Crossing Detection, Cross Counting, Crowd Density Detection, Queue Length Detection and License Plate Detection, might be mutually exclusive due to performance limitation. When the checkbox of Switch is in grey color and unable to check, that means another AI function was enabled in this camera already.

5.4.1.1 - FD (Face Detection)

Enabling this function is a great way to improve how you monitor the different areas that you want to keep an eye on. When human faces are detected, your NVR will activate recording, and it will also send an alert. This makes it ideal for restricted places where there shouldn't be people roaming around at particular times.

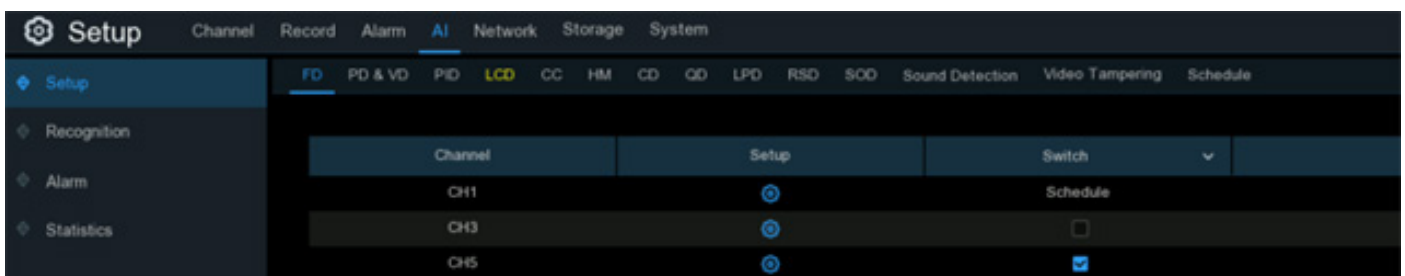

Switch: Tick the checkbox to enable the face detection.

Setup: Click setup  button for further settings:

Channel: to choose the channel you want to set.

Snap Mode: select how snapshots containing a recognized face will be captured. This can affect the number of facial recognition notifications that you will receive:

- **Realtime Mode:** the camera tracks and captures the face of someone entering and leaving the facial detection area. You'll get two notifications in the Alarm Notification Panel - once when the face is first detected and again as the face leaves the facial detection area. This is useful if you want to continuously monitor someone's presence in an area and get alerts in real-time.
- **Optimal Mode:** a single, best snapshot of the face is captured.
- **Interval Mode:** you can specify the number of snapshots to take and the time interval between snapshots.
 - **Snap Num:** the number of snapshots to take
 - **Snap Frequency:** the time interval between snapshots

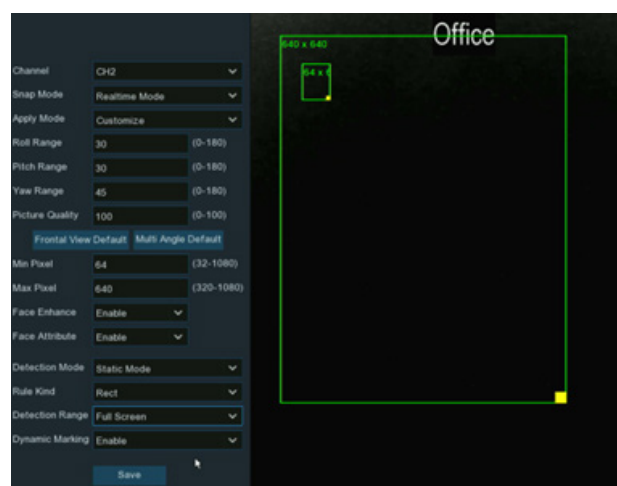

EN

Apply Mode: There are three options available:

- **Frontal View:** the facial recognition engine is optimized to scan for faces approaching the camera straight-on.
- **Multi Angle:** the facial recognition engine is optimized to scan for faces approaching the camera from different angles.
- **Customize:** the facial recognition engine is optimized to scan for faces approaching the camera from customized angles
 - **Roll Range:** set the range of face rotation.
 - **Pitch Range:** set the range of face pitch
 - **Yaw Range:** set the range of face horizontal flipping
 - **Picture Quality:** set the picture quality
 - **Frontal View Default:** to load default values of front view
 - **Multi Angle Default:** to load default values of multi angle view

Min Pixel: The minimum face size in pixels. The smaller the number of pixels, the more faces the camera can recognize. If the camera is recognizing too many unwanted distant faces, try increasing the minimum pixel value to train the camera to look for larger faces that are typically at a closer distance.

Max Pixel: The maximum face size in pixels. If you would like the camera to detect faces within proximity to each other, try increasing the maximum pixel value, otherwise leave the default value.

Face Enhance: Face enhancement makes it easier to recognize the moving faces, but it may lower the whole picture quality.

Face Attribute: Enable this function to detect gender, age, mask, glasses and facial expression.

Detection Mode: In Static Mode, all objects in the camera's field of view will be analyzed. In Motion Mode, only moving objects will be analyzed.

Rule Kind: Rect (rectangular) and **Line** (linear):098

- If you choose **Rect** mode, you can choose **Full Screen**, the entire view of the camera is enabled for face detection as the detection area, or you can choose **Customize** to adjust the size of rectangular to focus the detection in a certain area.

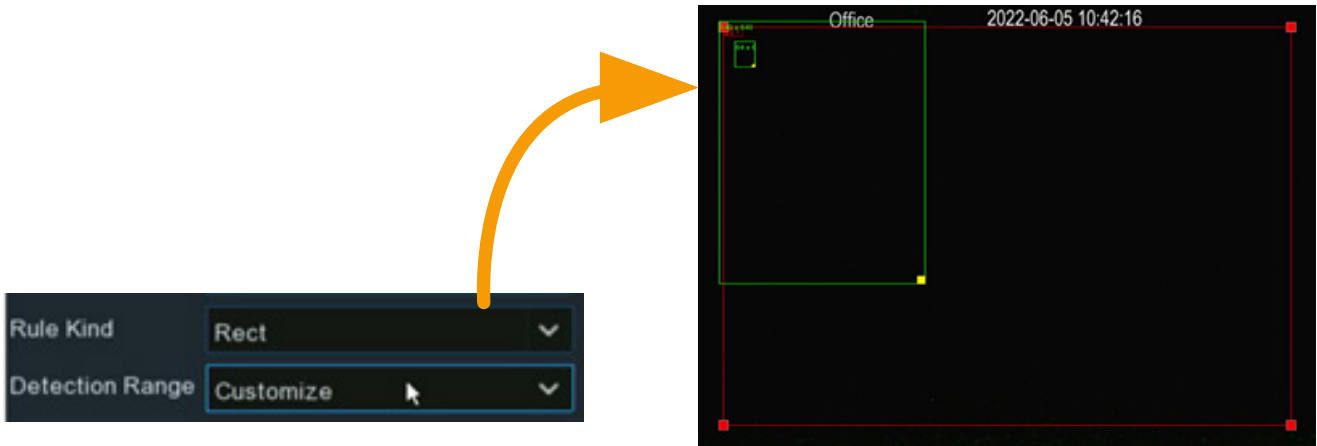

- If you choose **Line** mode, you need to adjust the position, length of the line, and choose the detection direction from B→A or A→B.

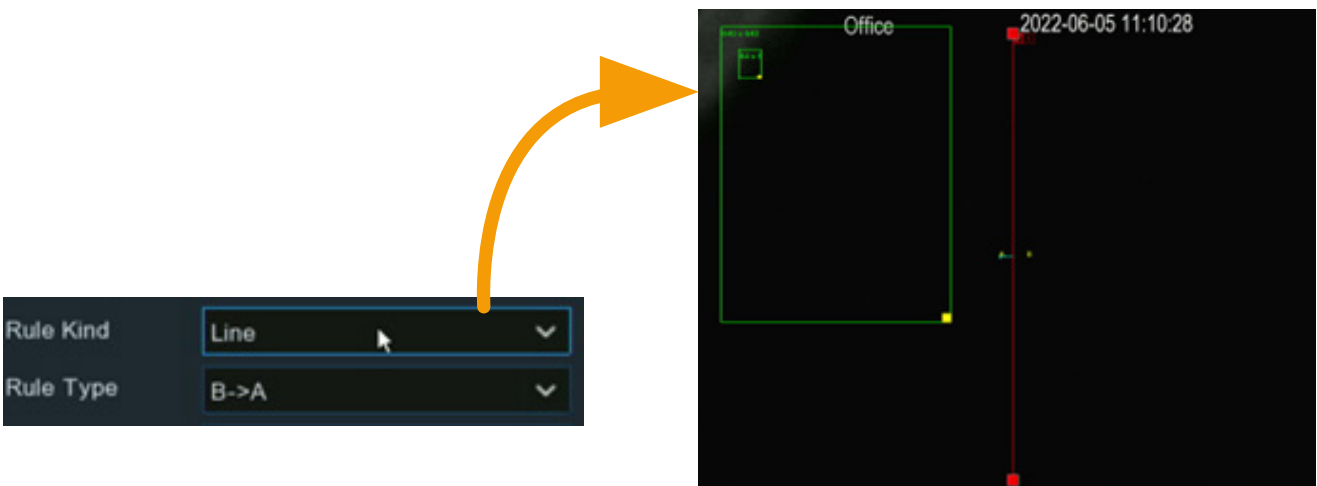

Dynamic Marking: If Disable is selected, the green tracking frame that surrounds a detected face will not be visible during Live View mode and playback.

5.4.1.2 - PD & VD (Human & Vehicle Detection)

When human beings and/or vehicles are detected, your NVR will activate recording, and it will also send an alert.

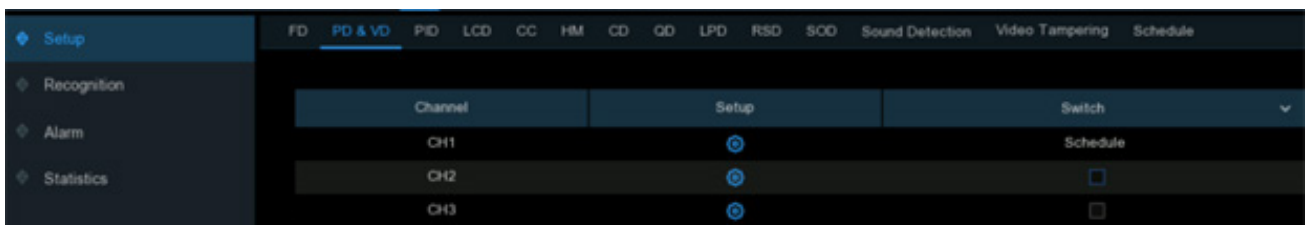

Switch: Tick the checkbox to enable the human & vehicle detection.

Setup: Click setup  button for further settings:

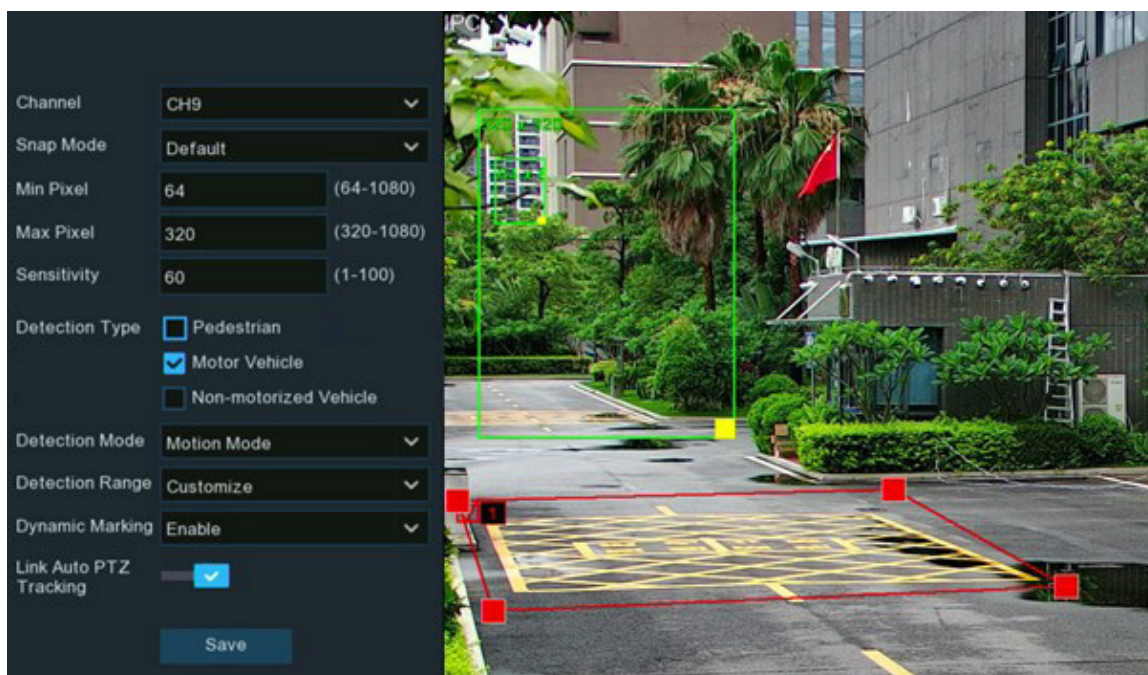

EN

Channel: to choose the channel you want to set.

Snap Mode: select how snapshots containing a recognized object will be captured. This can affect the number of notifications that you will receive:

- **Default:** a single, best snapshot of the detected object is captured.
- **Realtime Mode:** the camera tracks and captures the objects entering and leaving the detection area. You'll get two notifications in the Alarm Notification Panel - once when the object is first detected and again as the object leaves the detection area. This is useful if you want to continuously monitor the object in an area and get alerts in real-time.
- **Interval Mode:** you can specify the number of snapshots to take and the time interval between snapshots.
 1. **Snap Num:** the number of snapshots to take
 2. **Snap Frequency:** the time interval between snapshots

Min Pixel: The minimum object size in pixels. The smaller the number of pixels, the more objects the camera can recognize. If the camera is recognizing too many unwanted distant objects, try increasing the minimum pixel value to train the camera to look for larger objects that are typically at a closer distance.

Max Pixel: The maximum object size in pixels. If you would like the camera to detect objects within proximity to each other, try increasing the maximum pixel value, otherwise leave the default value.

Sensitivity: Adjust the sensitivity level of the detection area. The higher the number, the more sensitive it will be when detecting objects.

Detection Type: to choose the detection targeted object.

Detection Mode: In Static Mode, all objects in the camera's field of view will be analyzed. In Motion Mode, only moving objects will be analyzed.

Detection Area: If you choose **Full Screen**, the entire view of the camera is enabled for human and/or vehicle detection as the detection area, or you can choose **Customize** to adjust the size of rectangular to focus the detection in a certain area.

Dynamic Marking: If Disable is selected, the green tracking frame that surrounds a detected object will not be visible during Live View mode and playback.

PTZ Auto Tracking: If your PTZ camera is connected, you might see this function. Enable to activate the PTZ auto tracking function. View more on 5.1.4.1.2.1 Controlling PTZ.

5.4.1.3 - PID (Perimeter Intrusion Detection)

Perimeter Intrusion Detection function detects people, vehicle or other objects which enter and loiter in a pre-defined virtual region, and some certain actions can be taken when the alarm is triggered.

Channel	Setup	Switch	Sensitivity
CH1		Schedule	3
CH2		<input type="checkbox"/>	3
CH3		<input type="checkbox"/>	3

Switch: To enable or disable the Perimeter Intrusion Detection.

Sensitivity: Adjust the sensitivity level of the perimeter intrusion region. The higher the number, the more sensitive the intrusion region will be.

Setup: Click to configure the detection conditions.



1. Select the channel you want to configure.
2. Select the detection targeted object.

3. Choose one of the **Rule Number**. It is the number of PID area. Maximum 4 areas you can set for PID function.
4. To enable the detection in **Rule Switch**.
5. Choose a **Rule Type**:
 - A→B: Camera will only detect the action from side A to side B;
 - B→A: Camera will only detect the action from side B to side A;
 - A↔B: Camera will detect the action from either side B to side A or side A to side B.
6. Use your mouse to click 4 points in the camera image to draw a virtual region. The sharp of the region should be a convex polygon. Concave polygon will be not able to save.
7. Click **Save** to save your settings.
8. If you want to modify the position or sharp of region, click the red box in the region, the borders of the region will be changed to red color. Long press the left button of your mouse to move the position of the region, or drag the corners to resize the region.
9. If you want to remove one of the regions from the camera image, click the red box in the region and then click **Remove** button. Click **Remove All** will delete all regions.
10. If you want the green tracking frame that surrounds a detected object to be invisible during live view mode and playback, then choose Disable in the **Dynamic Marking**.

5.4.1.4 - LCD (Line Crossing Detection)

Line Crossing Detection function detects people, vehicle or other objects which cross a pre-defined virtual line, and some certain actions can be taken when the alarm is triggered.

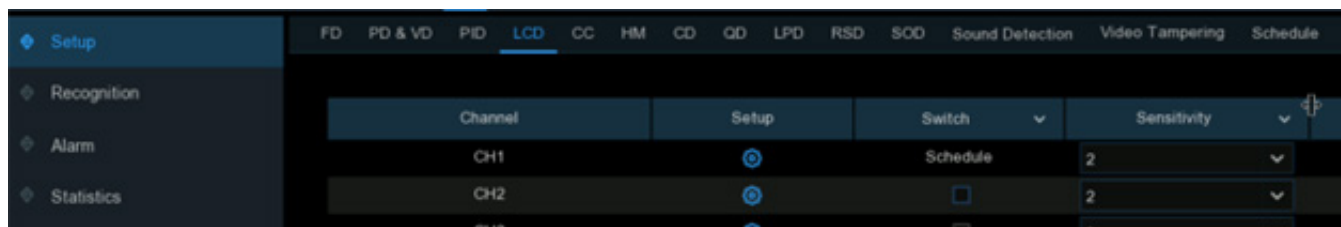

Switch: To enable or disable the Line Crossing Detection.

Sensitivity: Adjust the sensitivity level. The higher the number, the more sensitive the detection will be.

Setup: Click to configure the detection conditions.



1. Select the channel you want to configure.
2. Select the detection targeted object.
3. Choose one of the **Rule Number**. It is the number of LCD lines. Maximum 4 lines you can draw.
4. To enable the detection in **Rule Switch**.
5. Choose a **Rule Type**:
 - A→B: Camera will only detect the action from side A to side B;
 - B→A: Camera will only detect the action from side B to side A;
 - A↔B: Camera will detect the action from either side B to side A or side A to side B.
6. Use your mouse to click 2 points in the camera image to draw a virtual line.
7. Click **Save** to save your settings.
8. If you want to modify the position or length of the line, click the red box in the line, the color of the line will be changed to red color. Long press the left button of your mouse to move the line, or drag the terminals to modify the length or position of the line.
9. If you want to remove one of the lines from the camera image, click the red box in the line and then click **Remove** button. Click **Remove All** will delete all lines.
10. If you want the green tracking frame that surrounds a detected object to be invisible during live view mode and playback, then choose Disable in the **Dynamic Marking**.

5.4.1.5 - CC (Cross Counting Detection)

Cross Counting function will count the times an object or person has crossed a counting line from both directions, and some certain actions can be taken when the alarm is triggered.

Channel	Setup	Switch	Sensitivity
CH1		Schedule	2
CH2		<input checked="" type="checkbox"/>	2
CH3		<input checked="" type="checkbox"/>	3

Switch: To enable or disable the cross-counting function.

Sensitivity: Adjust the sensitivity level. The higher the number, the more sensitive the detection will be.

Setup: Click to configure the detection conditions.

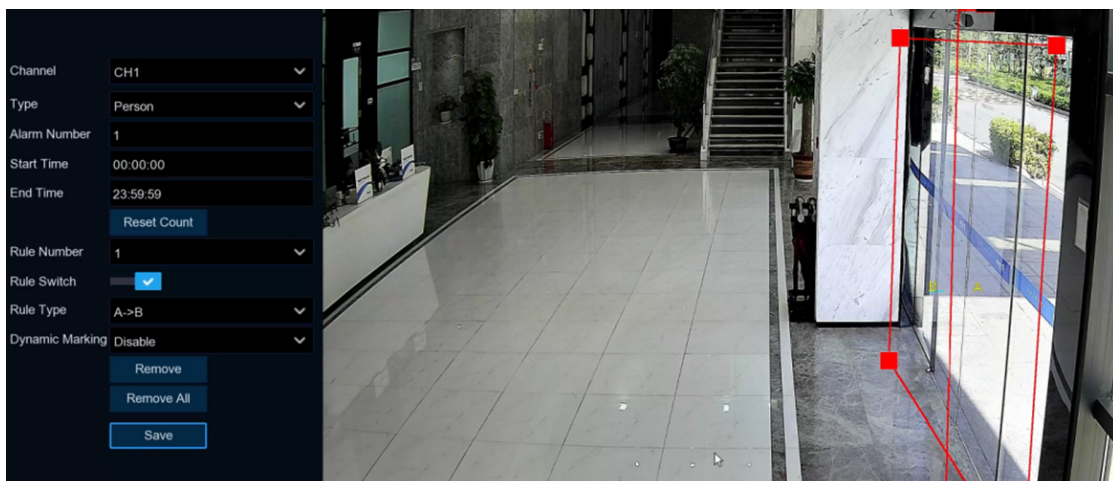

1. Select the channel you want to configure.
2. Select the detection targeted object:
 - **Motion:** All moving subjects will be detected by the system
 - **Person:** Only human beings will be detected
 - **Vehicle:** Only vehicles will be detected.
3. Input the **Alarm Number**. The NVR will send an alert if the number of entries minus the number of exits exceeds the alarm number. E.g., the number of entries is 601 while the number of exits is 400, and the alarm number you set is 200, $601 - 400 = 201 > 200$, then the NVR will send an alert.
4. Set the detection start time.
5. Set the detection end time.
6. To enable the detection in **Rule Switch**.
7. Choose a **Rule Type**:
 - **A→B:** If a targeted object is detected moving from side A to side B, the system will count 1 to enter number; if a target object is detected moving from side B to side A, the system will count 1 to exit number.
 - **B→A:** If a targeted object is detected moving from side B to side A, the system will count 1 to enter number; if a targeted object is detected moving from side A to side B, the system will count 1 to exit number.
8. Use your mouse to click 2 points in the camera picture to draw a virtual line. You will see a rectangular box coming along with the line together. Only the subject touches the borders in both sides will be recorded as a complete cross. Adjust the size of the rectangular box according to the mounting position of camera and the size of expected detection target.
9. Click **Save** to save your settings.
10. If you want to modify the position or length of the line, click the red box in the line, the color of the line will be changed to red color. Long press the left button of your mouse to move the line, or drag the terminals to modify the length or position of the line.
11. If you want to remove the line from the camera picture, click the red box in the line and then click **Remove** button or click **Remove All** directly.
12. The statistical data of cross counting will be displayed on the left top corner of the image.
13. If you want to clear the statistical data of cross counting, click the **Reset Count** button.
14. If you want the green tracking frame that surrounds a detected object to be invisible during live view mode and playback, then choose **Disable** in the **Dynamic Marking**.

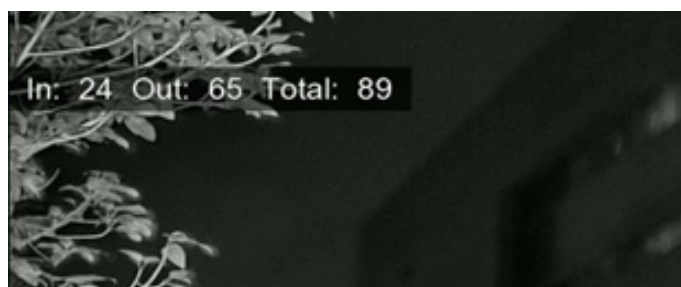
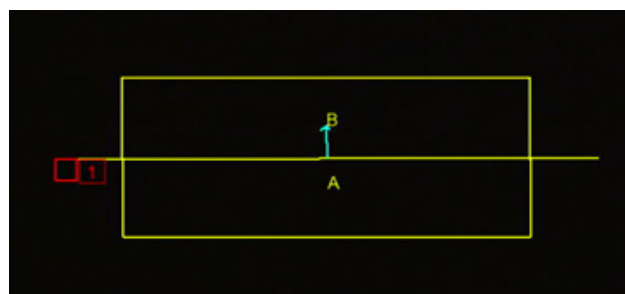

5.4.1.6 - HM (Heat Map)

Heat Map is a video analytics tool to provide a graphic overlay in the form of a heat map displaying the area and frequency of motion detected. This is especially useful for retail businesses to track customer movement to better understand consumer behavior. It can also be used to evaluate the traffic of populated areas such as amusement parks or museums.

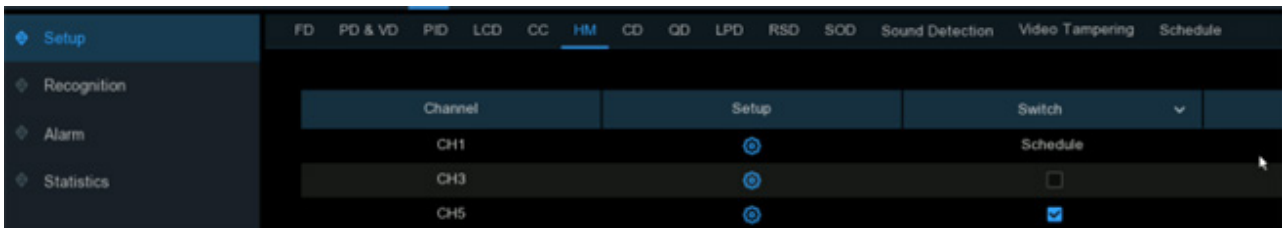

Switch: To enable or disable the heat map function.

Setup: Click  to configure the detection conditions.

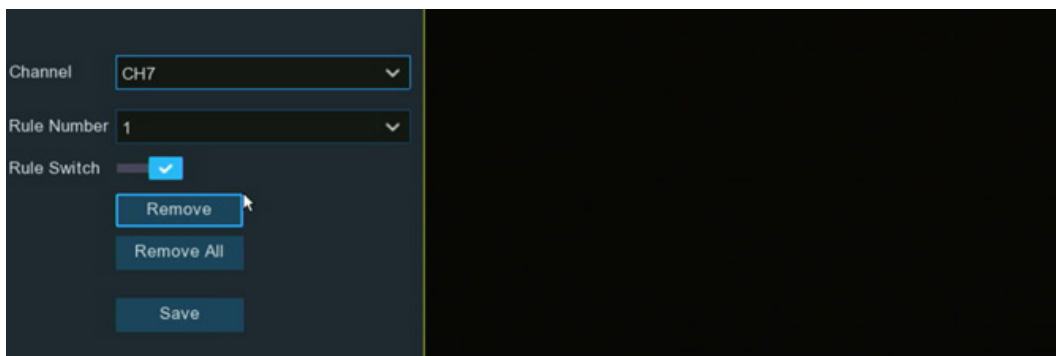

1. Select the channel you want to configure.
2. To enable the detection in Rule Switch.
3. As default, the whole image will be activated as heat map region. If you want to modify the region, click the red box on the top left corner, and then the borders of the region will be changed to red color. Click and hold each red-colored square to adjust the heat map region.
4. Click **Save** to save your settings.
5. If you want to delete the region, Click **Remove All**.

5.4.1.7 - CD (Crowd Density Detection)

Crowd density detection is based on face detection technology, which is used to detect crowd gathering to maintain a controllable order in certain area. When the total number of detected people in a certain area exceeds the pre-set allowed number, the system will send an alert.

EN

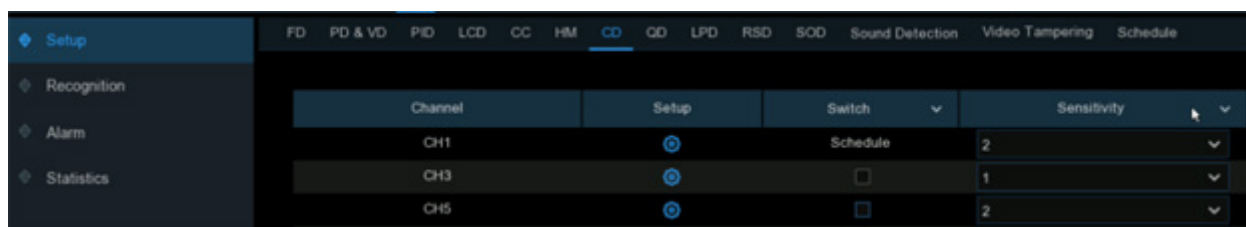

Switch: To enable or disable the heat map function.

Sensitivity: Adjust the sensitivity level. The higher the number, the more sensitive the detection will be.

Setup: Click to configure the detection conditions.

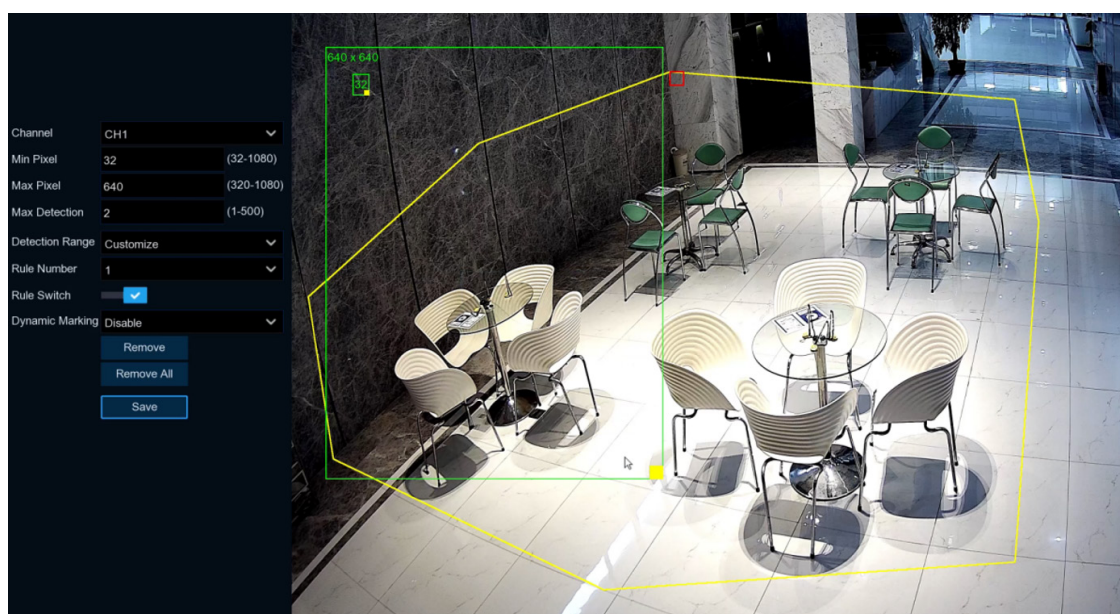

1. Select the channel you want to configure.
2. To set the minimum & maximum pixel of face size.
3. Set the maximum allowed number. When the total number of detected people in the selected area exceeds the pre-set allowed number, the system will send an alert.
4. You can choose **Full Screen**, the entire view of the camera is enabled for face detection as the detection area. Or you can choose **Customize**, and then use your mouse to click 8 points in the camera image to draw a virtual region.
5. To enable the detection in Rule Switch.
6. Click **Save** to save your settings.
7. If you want to remove the customized region, click **Remove All** directly.
8. If you want the green tracking frame that surrounds a detected object to be invisible during live view mode and playback, then choose **Disable** in the **Dynamic Marking**.

5.4.1.8 - QD (Queue Length Detection)

Queue length detection is used to detect the status of a queue, including its length and staying time.

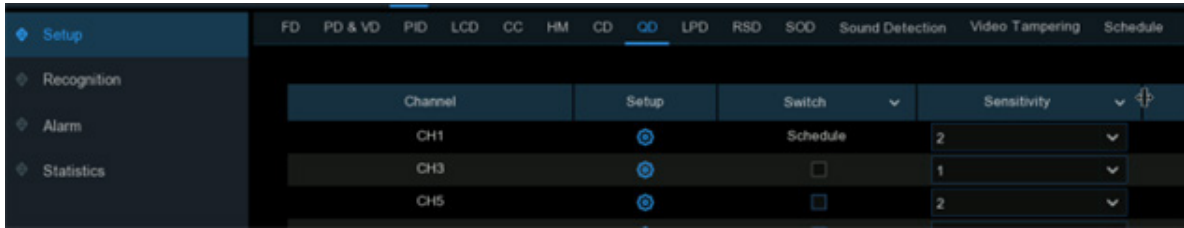

Switch: To enable or disable the queue length detection function.

Sensitivity: Adjust the sensitivity level. The higher the number, the more sensitive the detection will be.

Setup: Click  to configure the detection conditions.

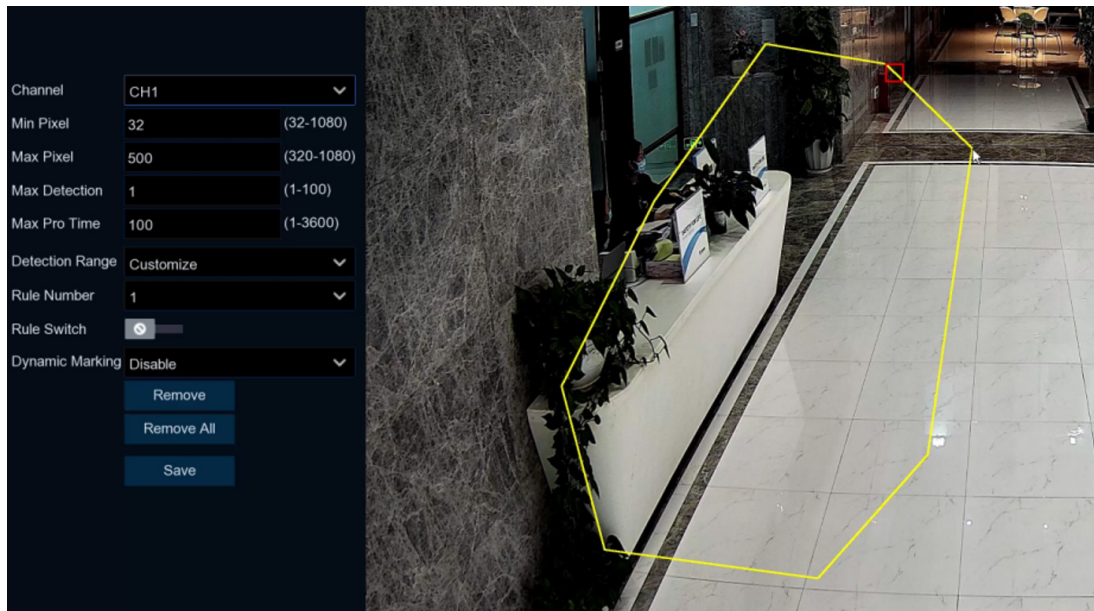

1. Select the channel you want to configure.
2. To set the minimum & maximum pixel of face size.
3. Set the maximum allowed number. When the total number of detected people in the line inside the detection area exceeds the pre-set allowed number, the system will send an alert.
4. Set the maximum staying time in seconds. The NVR will send an alert if the staying time of the queue is longer than the given staying time.
5. You can choose **Full Screen**, the entire view of the camera is enabled for face detection as the detection area. Or you can choose **Customize**, and then use your mouse to click 8 points in the camera image to draw a virtual region.
6. To enable the detection in Rule Switch.
7. Click **Save** to save your settings.
8. If you want to remove the customized region, click **Remove All** directly.
9. If you want the green tracking frame that surrounds a detected object to be invisible during live view mode and playback, then choose Disable in the **Dynamic Marking**.

5.4.1.9 - LPD (License Plate Detection)

License Plate Detection function, also called "Automatic License/Number Plate Recognition (ANPR)", helps to detect and record the license plate number.

EN

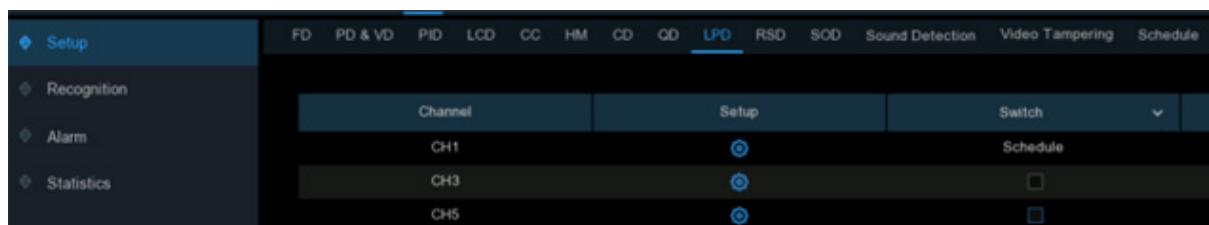

Switch: To enable or disable the crowd density detection function.

Setup: Click to configure the detection conditions.



1. Choose a channel you want to set.
2. Select how snapshots containing a recognized license plate will be captured. This can affect the number of license recognition notifications that you will receive:
 - **Default Mode:** a single, best snapshot of the license plate is captured.
 - **Realtime Mode:** the camera tracks and captures the license plate of vehicle entering and leaving the detection area. You'll get two notifications in the Alarm Notification Panel - once when the license plate is first detected and again as the vehicle leaves the detection area. This is useful if you want to continuously monitor the vehicle's presence in an area and get alerts in real-time.
 - **Interval Mode:** you can specify the number of snapshots to take and the time interval between snapshots.
 - **Snap Num:** the number of snapshots to take
 - **Snap Frequency:** the time interval between snapshots
3. To set the minimum & maximum pixel of size of license plate.
4. Adjust the sensitivity level. The higher the number, the more sensitive the detection will be.

5. Choose one of the license plate types:
 - European license plate: mainly used in European countries.
 - American license plate: mainly used in United States.
6. Choose the detection mode:
 - **Static Mode:** all vehicles' license plates in the camera's field of view will be analyzed.
 - **Motion Mode:** only license plates of moving vehicles will be analyzed.
7. You can choose **Full Screen**, the entire view of the camera is enabled as the detection area. Or you can choose **Customize**, and then adjust the size of the detection region.
8. If you want the green tracking frame that surrounds a detected object to be invisible during live view mode and playback, then choose Disable in the **Dynamic Marking**.
9. **LPD Enhance:** Used to set whether to enable license plate detection enhancement.

Day Level: Used to set the day time level, which is applicable to day time scenarios. The larger the level value is, the brighter the image is. The lower the level value is, the darker the image is. The level value range is 0–255.

Night Level: Used to set the nighttime level, which is applicable to nighttime scenarios. The larger the level value is, the brighter the image is. The lower the level value is, the darker the image is. The level value range is 0–255.

NOTE: When the LPD function is enabled, if LPD enhancement is also enabled, the image brightness of the camera can be adjusted in accordance with the configured level value. Meanwhile, the device automatically adjusts its day time level or nighttime level in accordance with whether the camera is enabled with IR mode. The two application scenarios are independent of each other.

To use LPD enhancement, you need to set **Exposure Compensation** to **Disable** and set **Shutter** to **Auto** on the image control page. After LPD enhancement is enabled, **Time Exposure** cannot be modified.

5.4.1.10 - RSD (Rare Sound Detection)

With the Rare Sound Detection function, it will alert you when your NVR detects abnormal sound, like baby crying, dog barking, and gunshot, and some certain actions can be taken when the alarm is triggered.

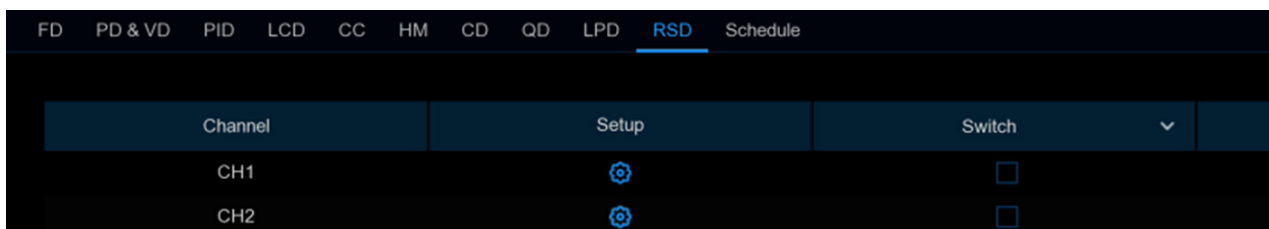

Switch: To enable or disable the detection.

Setup: Click  to configure the detection conditions.

Channel: Select an available to configure.

Sensitivity: Adjust the sensitivity level. The higher the number, the more sensitive the detection will be.

Detection Type:

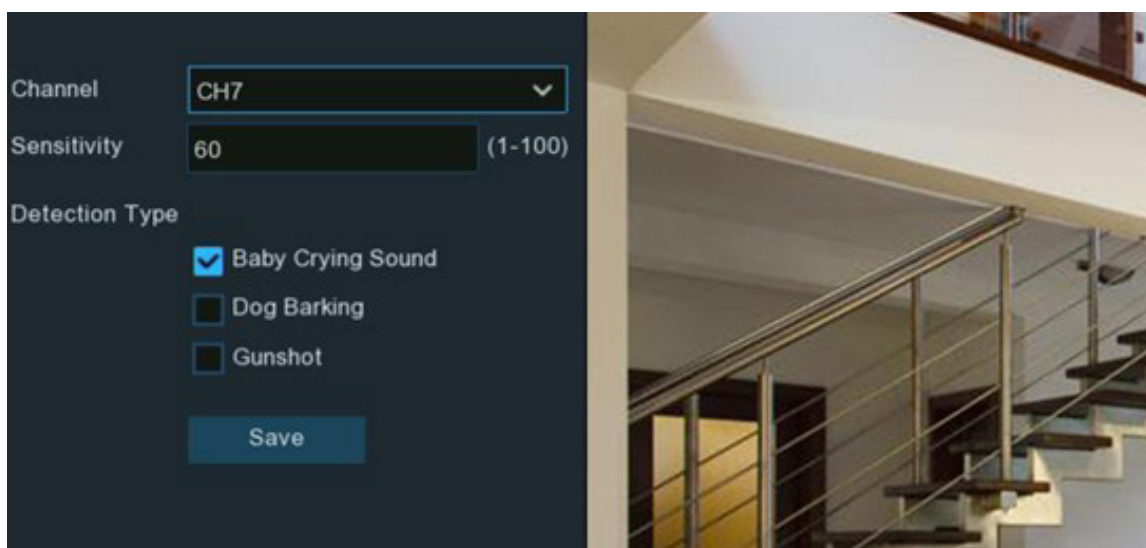

EN

- **Baby Crying Sound:** Tick to enable baby crying detection.
- **Dog Barking:** Tick to enable dog barking detection.
- **Gunshot:** Tick to enable gunshot detection.

Click **Save** to save your settings.

5.4.1.11 - SOD (Stationary Object Detection)

Stationary Object Detection function detects the objects left over or lost in the pre-defined region, such as the baggage, purse, dangerous materials, etc., and a series of actions can be taken when the alarm is triggered.

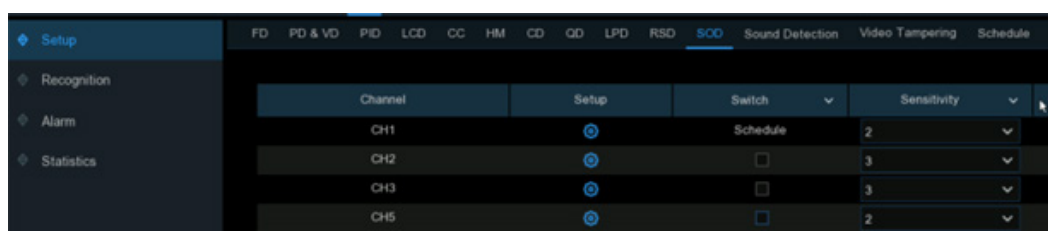

Switch: Check the box to enable SOD function.

Sensitivity: Set the sensitivity level. Level 1 the lowest sensitivity level while level 4 is the highest sensitivity level.

Click **Setup** icon to draw a virtual region in the camera image.

1. Choose one of the **Rule Number**. It is the number of SOD area. Maximum 4 areas you can set for SOD function.
2. To enable the detection in **Rule Switch**.
3. Choose a **Rule Type**.
 - **Legacy:** NVR will only detect the left-over objects;
 - **Lost:** NVR will only detect the lost objects;
 - **Legacy & Lost:** NVR will detect both left-over & lost objects.

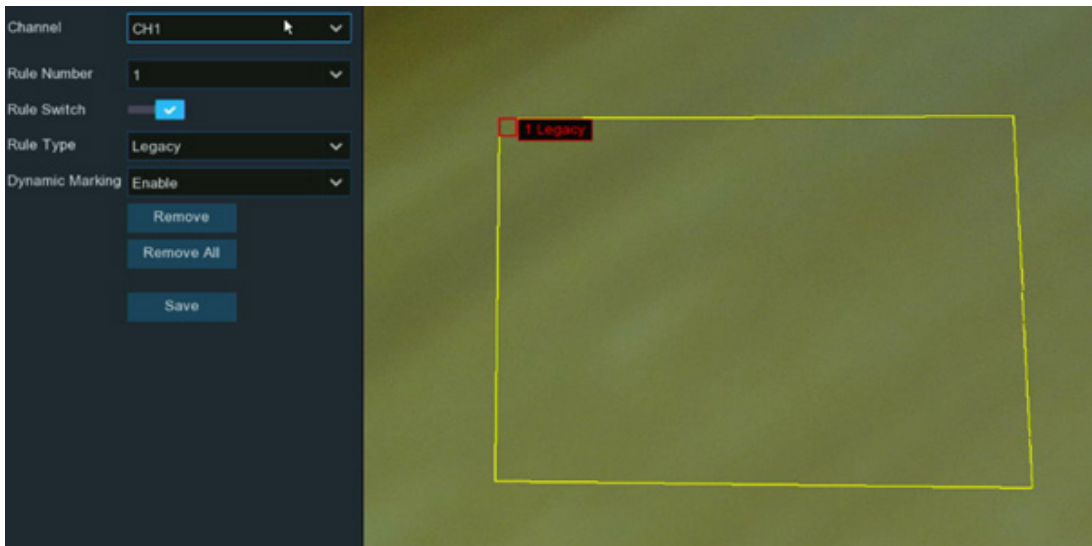

4. Use your mouse to click 4 points in the camera image to draw a virtual region. The shape of the region should be a convex polygon. Concave polygon will be not able to save.
5. Click **Save** to save your settings.
6. If you want to adjust the size of the region, click the red box in the region, the borders of the region will be changed to red color. Long press the left button of your mouse to move the whole region, or drag the corners to resize the region.
7. If you want to remove one of the regions from the camera image, click the red box in the region and then click **Remove** button. Click **Remove All** will delete all regions.

- i** **NOTE:**
1. The detection area shall be greater than or equal to the size of the detected object, such as the detection of a white bottle.
 2. The detected object cannot be covered.

5.4.1.12 - Sound Detection

With the sound detection, it will alert you when your NVR detects audio that matches or exceeds the set trigger level, and some certain actions can be taken when the alarm is triggered.

EN

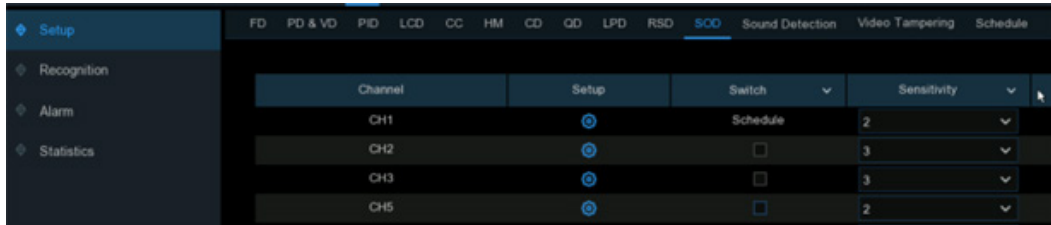

Switch: enable or disable sound detection.

Rise: enable or disable sound rise detection.

Rise Sensitivity: change the sensitivity level. The higher the number, the more sensitive your NVR will be when detecting sound.

Sound Intensity: Set a threshold of sound intensity, the lower value, the more sensitivity.

Decline: enable or disable sound Decline detection.

Decline Sensitivity: change the sensitivity level. The higher the number, the more sensitive your NVR will be when detecting sound.

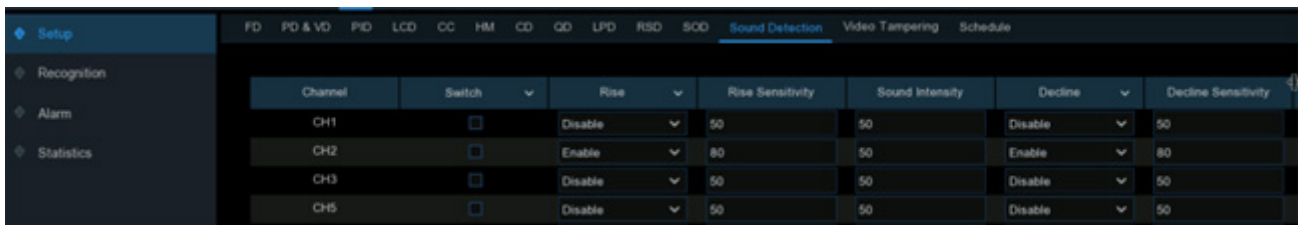

Schedule: Each square represents 30 minutes. Using the mouse, click on a particular square to change or click and drag the mouse over the squares corresponding to your desired period. The sound detection will be activated if the time table is in blue color, oppositely the detection will be inactivated if the time table is in black color.

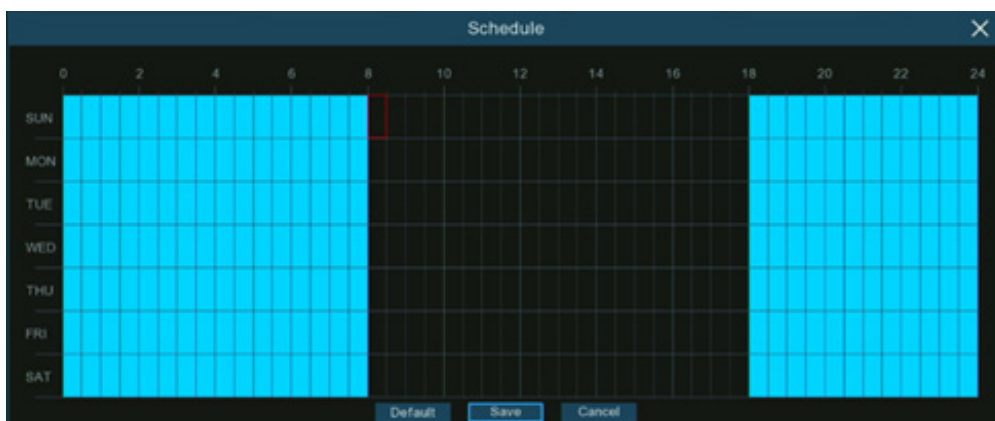

5.4.1.13 - Video Tampering

Video Tampering detects the occlusion of camera images, and some certain actions can be taken when the alarm is triggered.



Switch: Enable or disable the function

Sensitivity: The sensitivity level is from 1 to 6, with a default value of 3. Higher sensitivity will be easier to trigger the detection.

5.4.1.14 - Schedule

You can configure the recording schedule for AI detection functions.

The interface might be different vary with different camera firmware.

EN

Interface A

1. Choose the channel you want to set.
2. Click on the mode radio button to choose one of the detection functions
3. By default, the detection is activated by 24 hours / 7 days, however you can change this according to your needs.
4. Each square represents 30 minutes. Using the mouse, click on a particular square to change or click and drag the mouse over the squares corresponding to your desired period. Squares in green color are active for deterrence.
5. The set schedule is valid only for one channel. If you want to use the same schedule for other channels, use **Copy** function.
6. Click **Save** to save changes made.
7. Right-click the mouse to exit.



Interface B

1. Choose a **Channel** you want to set.
2. Tick the Enable button to activate the AI recording schedule
3. Click on the mode radio button to choose one of the detection functions. The detection functions with red-colored radio button are mutually exclusive, one and only one of them can be activated at the same time.
4. Each square represents 30 minutes. Using the mouse, click on a particular square to change or click and drag the mouse over the squares corresponding to your desired period. Squares in green color are active for deterrence.
5. Block in grey color is occupied and unable to select. Block in black color is available to select.
6. Click **Apply** to save.

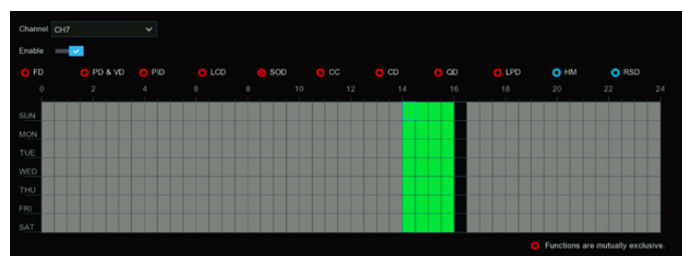

5.4.2 - AI Recognition

With the face detection & license plate detection functions, the system supports to recognize faces and vehicle license, you would need to configure the recognition algorithm model and manage the database.

5.4.2.1 - Model Configuration

To choose the face recognition AI algorithm model.

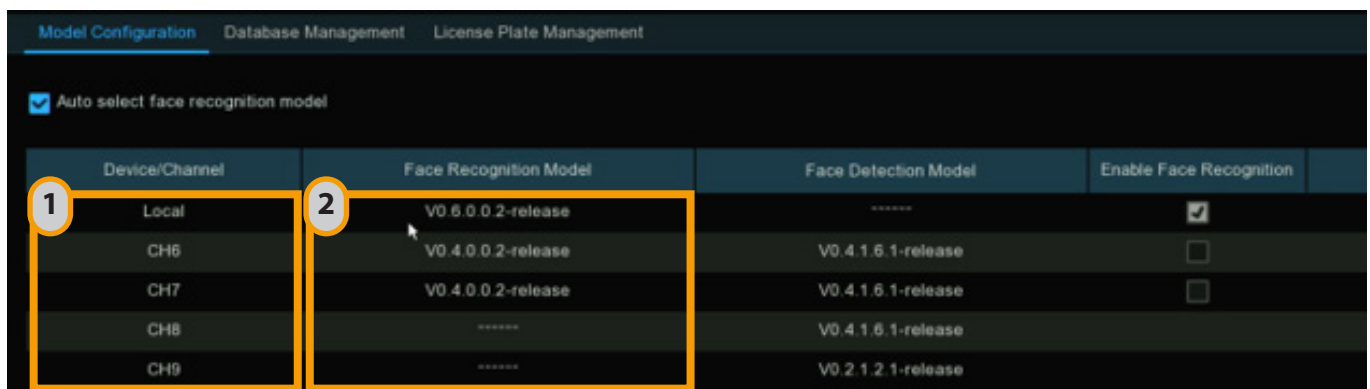

Device/Channel	Face Recognition Model	Face Detection Model	Enable Face Recognition
Local	V0.6.0.0.2-release	*****	<input checked="" type="checkbox"/>
CH6	V0.4.0.0.2-release	V0.4.1.6.1-release	<input type="checkbox"/>
CH7	V0.4.0.0.2-release	V0.4.1.6.1-release	<input type="checkbox"/>
CH8	*****	V0.4.1.6.1-release	
CH9	*****	V0.2.1.2.1-release	

- 1 – **Local:** NVR
CH*: Cameras
- 2 – If the NVR or a camera possesses the recognition capability, you will see the Model version on the column of **Face Recognition Model**

The face AI algorithm mainly includes two parts: Detection and Recognition.

- Detection is mostly used to detect and capture face images. Generally, the detection capability is possessed by IP cameras.
- Recognition is mostly used to extract, analyze and compare the face features. Recognition capability is possessed by the NVR and some of IP cameras.

To fully implement the face detection and recognition function, the system will select a face recognition model automatically when you use the face AI function at the first time.

If you want to choose the model by manual, untick the checkbox of **Auto select recognition model**, and then tick the checkbox of the model you want to enable.

Rules & advices for manual selection:

1. At least one face recognition algorithm model must be enabled, otherwise the face recognition function would malfunction.
2. Between NVR and camera, you can only select either-or.
3. Models with across versions are disallowed to be select.

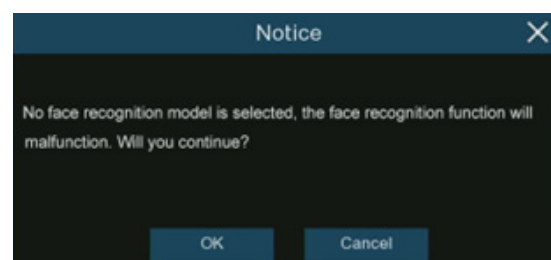

4. Newer version (with bigger digital sequence) is preferred to be selected due to its algorithm optimization and database update.
5. Multiplex models with same version are allowed & recommended to be enabled. This would help to decrease the analysis loading on a single NVR or camera and accelerate the recognition.
6. If one or more selected cameras (not all) are off-line, the recognition mission will be automatically assigned to the rest of selected camera(s).
7. When the Model is enabled on a single camera and if the camera is off-line, the face recognition will stop working. System will send an alert notification shown as below. Click **OK** to let the system automatically select a new model. If you click **Cancel**, you would need to configure the recognition model by manual later.
8. If you want to change the model to a different version, the system would send you a notice, click **OK** to continue.
9. If the recognition model has been changed to a different version, the system would send you a notice, click **OK** to continue. If you click **Cancel**, you would need to go to **Database Management** menu and then click **Update facial features** button to update the database.

Device/Channel	Face Recognition Model	Face Detection Model	Enable Face Recognition
Local	VO 6.0.0.2-release	-----	<input type="checkbox"/>
CH1	VO 4.0.0.2-release	VO 4.1.6.1-release	<input checked="" type="checkbox"/>
CH2	VO 2.0.5.1-beta	VO 2.1.2.1-release	<input type="checkbox"/>
CH3	VO 3.0.0.1-release	VO 3.1.2.1-release	<input type="checkbox"/>
CH6	VO 4.0.0.2-release	VO 4.1.6.1-release	<input checked="" type="checkbox"/>
CH7	VO 4.0.0.2-release	VO 4.1.6.1-release	<input checked="" type="checkbox"/>
CH8	-----	VO 4.1.6.1-release	<input type="checkbox"/>
CH9	-----	VO 2.1.2.1-release	<input type="checkbox"/>
CH12	VO 4.0.0.2-release	VO 4.1.6.1-release	<input checked="" type="checkbox"/>

EN

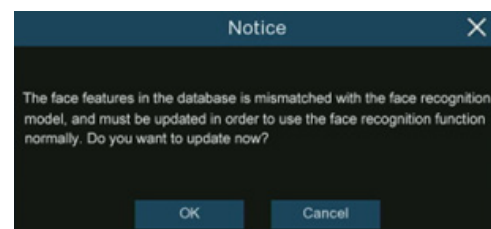
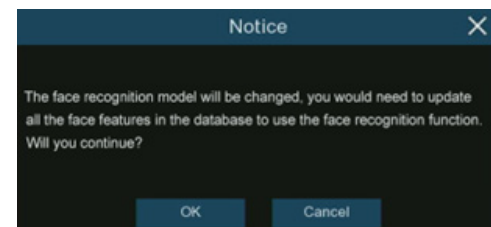
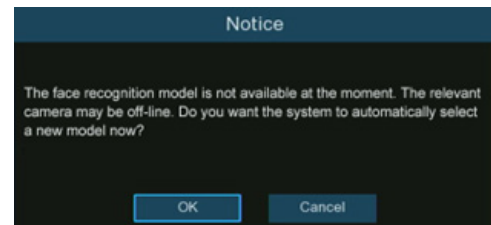

Model Configuration		Database Management	License Plate Management
<input type="button" value="Import Database"/>		<input type="button" value="Backup Database"/>	<input type="button" value="Update facial features"/>
		Group Name	
1	<input checked="" type="checkbox"/>	Allow List	
2	<input checked="" type="checkbox"/>	Block List	
3	<input type="checkbox"/>	Stranger	
4	<input checked="" type="checkbox"/>	Group 1	

5.4.2.2 - Face Recognition Database Management

You're able to create and manage the face profiles (database) to classify different people into different groups in order to quickly identify people in remote and realize intelligent alarm beforehand.

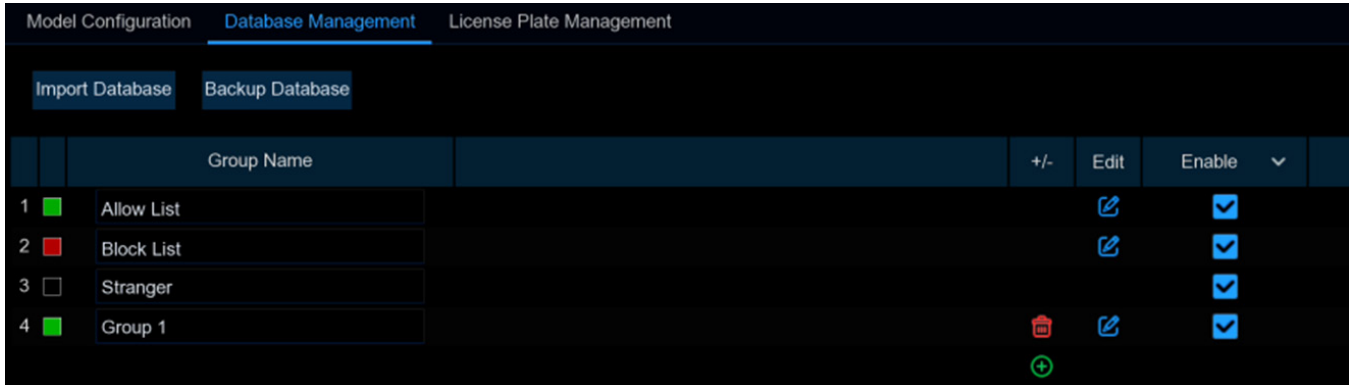

There are 3 default groups:

- **Allow List:** Mostly used to define a list of people that are regarded as acceptable or trustworthy, such as family members, colleagues, frequent customers, etc.
- **Block List:** Mostly used to define a list of people that are regarded as unacceptable or untrustworthy and should be excluded or avoided.
- **Stranger:** All ungrouped people will be identified as stranger.

You can click add button to create or click delete button to delete customized group.

If you want to make a backup of your database, use the **Backup Database** function to export it to your USB flash drive. The exported database can be imported to the same or another NVR by using **Import Database** function (Please note, this will overwrite the existing settings and face profiles.).

Tick the checkbox of **Enable** to enable the group. You would need to create face profiles (add face images) to the groups in order to sufficiently exert the identification effects.

5.4.2.2.1 - Create Face Profile from Local Storage Device

This section will show how to create face profiles from face images that have been captured and stored on your NVR.

EN

1 – Click the **Edit** button of the group that you would like to create face profiles for.



2 – From the Group window, click the **Import** button, then click the **Local Storage Device** button.

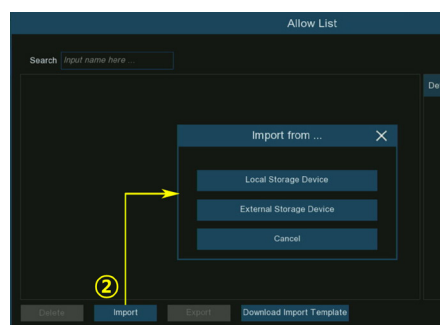

3 – **Channels:** All channels are set to search by default. You can specify the cameras you want to search on.

4 – Use the calendar to specify the date range.

5 – Choose the day duration, and then use the arrow buttons to quickly display face images from the previous or next day(s).

6 – The search result will be displayed in the face list automatically. Use the arrow buttons to display previous or next page of results.

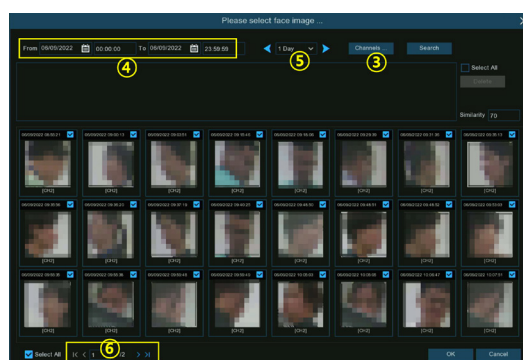

7 – You can narrow the search result by using the similarity:

- **A:** First, select the targeted face image(s) from the search result.
- **B:** And then set the **Similarity** value. It is the face similarity threshold (%). The higher the number is, the more precise the result will be.
- **C:** Click **Search** button, the system will search for faces with an equal or greater similarity than the specified value.
- **D:** If you want to search from other days, choose the day duration, and then use the arrow buttons to quickly display face images from the previous or next day(s).
- **E:** Tick the checkbox to select individual face image, or tick **Select All** to select all face images in current page of search result.
- **F:** Once you've selected one or more face images, click the **OK** button. The system will go to profile edit page.

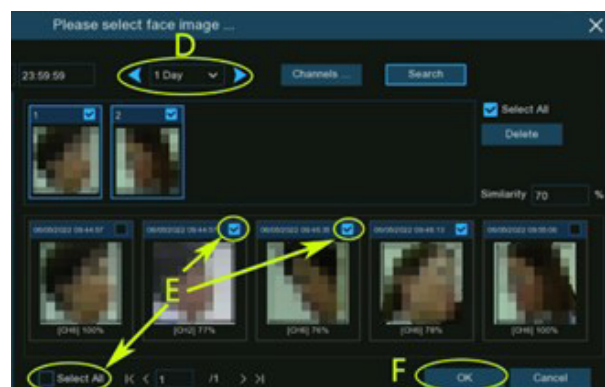
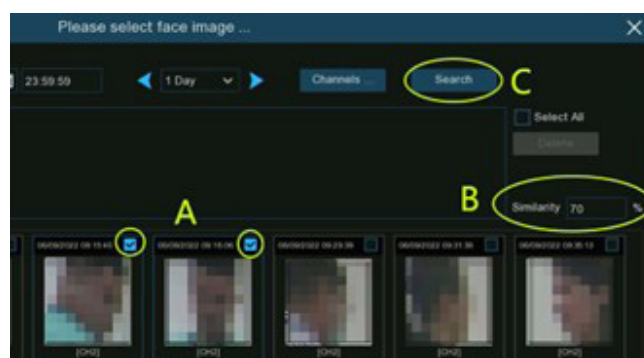

- 8 – Click on a face image, then enter their identification details, such as the person's name and age. By default, each face image is given a face ID as its name.
- 9 – When finished, click **Import** button. The face profile is now created and assigned to the group.

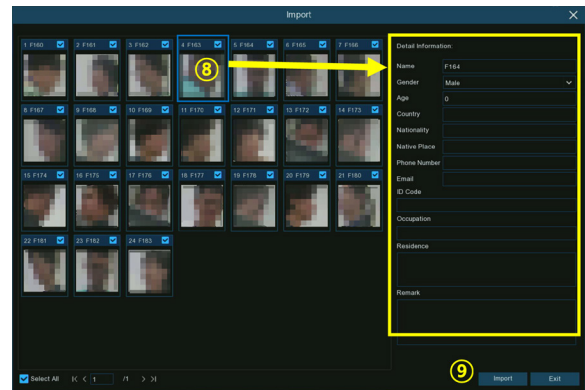

5.4.2.2.2 - Create Individual Face Profile from External Storage Device

- 1 – Copy the face images to your USB flash drive, and then insert the USB device into the USB port of the NVR.

NOTE: The supported formats of face image are ".jpg", ".jpeg", ".png", and ".bmp". The supported dimension of the image is from 80x80 to 800x800 pixels, and the maximum supported size is 500KB.

Name	Type	Size	Dimensions
Anna.jpeg	✓ JPEG File	32 KB	700 x 720
Jack.jpeg	✓ JPEG File	88 KB	800 x 683
David.jpg	✗ JPG File	168 KB	800 x 891
Jenny.jpeg	✗ JPEG File	82 KB	1000 x 1000
Selina.jpg	✗ JPG File	626 KB	800 x 683
Victoria.jpg	✗ JPG File	4,371 KB	6000 x 4000

- 2 – Click the **Edit** button  of the group that you would like to create face profiles for.

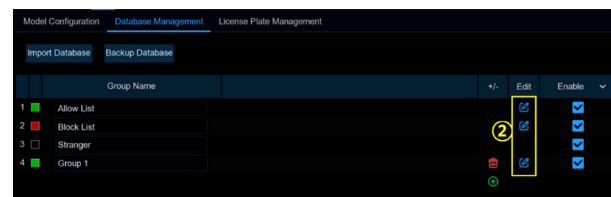

- 3 – From the Group window, click the **Import** button, then click the **External Storage Device** button.

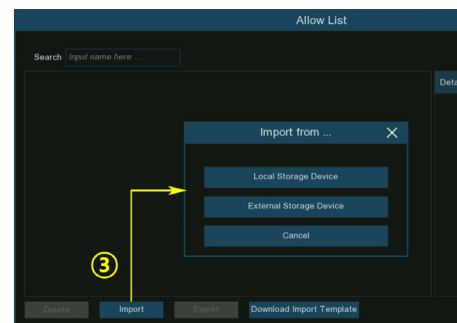

- 4 – Click on the face image you want to import, and then click OK button.

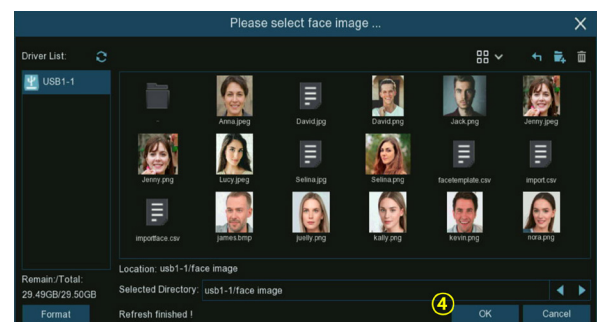

- 5 – Edit the face profile of the people.
- 6 – Click setup button to configure the voice prompt for the person. View more on 5.3.9. Voice Prompts to learn how to configure this function.

i NOTE: The voice file you import here takes effect only to this person. If you had set several periods of time, you would need to import voice file for each period.

- 7 – Click setup button to configure the **Alarm Channel**. The system will alert when the face is detected and captured by the selected cameras.
- 8 – Click **Import** button to import the face profile.

- 9 – Now you will see an add button displayed in the **Additional Face Image** window. You are able to add additional face images at different angles for the same person to improve face recognition accuracy:

Click the add button , to add images from local and/or external storage device. Maximum 10 images allowed to add.

Click delete button to delete select image.

Click **Modify** button to finish, then click **Exit** button or right click your mouse to exit.

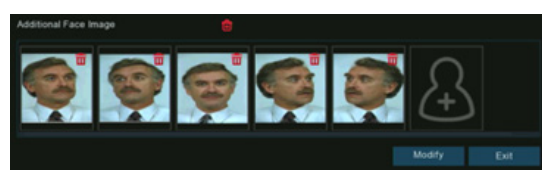
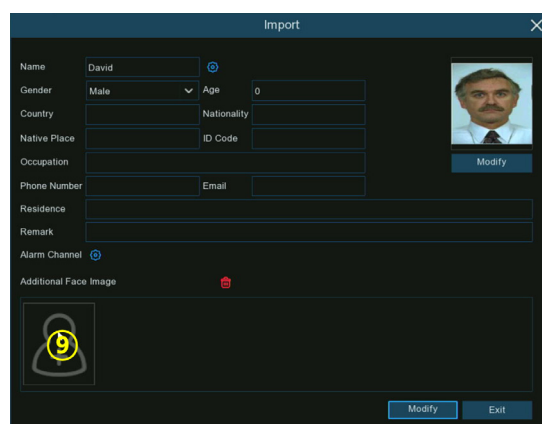
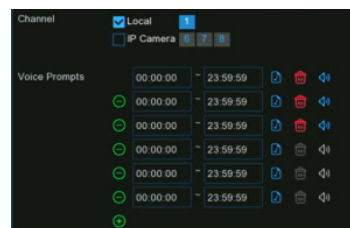
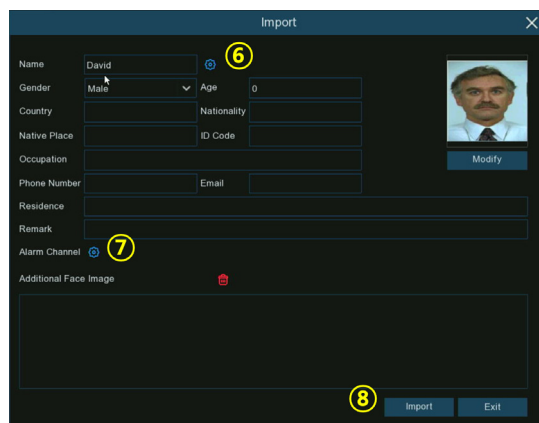

5.4.2.2.3 - Create Bulk Face Profile from External Storage Device

If you want to create a batch of face profiles at once, please proceed as below:

1. Click the **Edit** button of the group that you would like to create face profiles for.

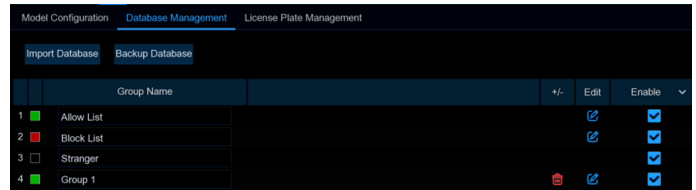

2. From the Group window, you will find the **Download Import Template** button.

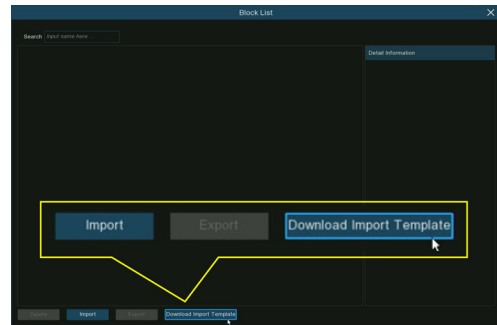

3. Insert your USB flash drive, and then click the Download Import Template button, a zip file named "import_template_enu.zip" will be downloaded into your USB flash drive.
4. Unzip the file, you will get 2 files shown as left.
5. Create a new folder, and give a name to it.



6. Copy the "facetemplate.csv" file and the face images into the folder. Make sure the formats of face image are ".jpg", ".jpeg", ".png", or ".bmp", the dimension is between 80x80 and 800x800 pixels, and the size is no more than 500KB.

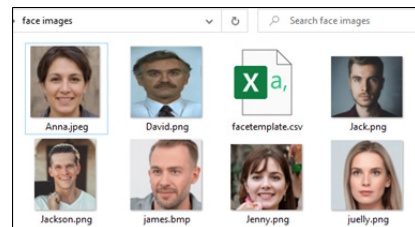

7. Double click on the "facetemplate.csv" file to run it with excel. The content is shown as below:

A	B	C	D	E	F	G	H	I	J	K	L	M	N	O	P
name	gender	age	image pat	country	nation	nativepos	idcode	occupaito	phone	email	domicile	remark			
xxxx	male	30	face/impc	China	Han natio	ZhuHai	20200903	zhuhai	1.46E+15	12348545	zhuhai	bukeyishuruzhongwen,bixuyongutf8			

Columns:

- **A:** Name of the person
- **B:** Gender of the person
- **C:** Age of the person
- **D:** Complete filename of the image, for example "David.png".
- **E:** Name of country/region where the person comes from.
- **F:** Race of the person
- **G:** Native place of the person
- **H:** ID number of the person
- **I:** Occupation/Job/Career of the person
- **J:** Phone number of the person
- **K:** Email address of the person
- **L:** Residence address of the person
- **M:** Remarks column

8. Edit the cells according to your actual conditions as illustrated as below:

NOTE: If you input a number uninterruptedly more than 11 digits in a cell, the system will display the number in scientific notation, e.g., "1.23457E+11". If so, you would need to adjust the format of the column to be "Text"

Select the column (especially the column of ID code and phone number) and then click right button of your mouse. Click Format Cells... on the pop-up menu.

Choose Text, and then click OK button.



name	gender	age	image path	country	nation	natvepos	iscode	occupation	phone	email	domicile	remark
Anna Jayce	Female	30	anna.png	UK	English	England	123456789	Professor	07-123 456 789	test@xxxxxx.com	No. xx, Downing Street, London	Test
Nora Martin	Female	30	nora.png	UK	English	England	123456790	Professor	07-123 456 790	test@xxxxxx.com	No. xx, Downing Street, London	Test
Shelly Clinton	Female	30	shelly.png	UK	English	England	123456791	Editor	07-123 456 791	test@xxxxxx.com	No. xx, Downing Street, London	Test
Sirna Donald	Female	30	sirna.png	UK	English	England	123456792	Photographer	07-123 456 792	test@xxxxxx.com	No. xx, Downing Street, London	Test
James Timothy	Male	30	james.png	UK	English	England	123456793	Director	07-123 456 793	test@xxxxxx.com	No. xx, Downing Street, London	Test
Juelly Smith	Female	30	juelly.png	UK	English	England	123456794	Cashier	07-123 456 794	test@xxxxxx.com	No. xx, Downing Street, London	Test
Kally Jones	Female	30	kally.png	UK	English	England	123456795	Reporter	07-123 456 795	test@xxxxxx.com	No. xx, Downing Street, London	Test
Kevin Williams	Male	30	kevin.png	UK	English	England	123456796	Manager	07-123 456 796	test@xxxxxx.com	No. xx, Downing Street, London	Test
Jenny Brown	Female	30	jenny.png	UK	English	England	123456797	Guide	07-123 456 797	test@xxxxxx.com	No. xx, Downing Street, London	Test
Lucy Taylor	Female	30	lucy.png	UK	English	England	123456798	Operator	07-123 456 798	test@xxxxxx.com	No. xx, Downing Street, London	Test
David Wilson	Male	30	david.png	UK	English	England	123456799	Scientist	07-123 456 799	test@xxxxxx.com	No. xx, Downing Street, London	Test
Jack Davis	Male	30	jack.png	UK	English	England	123456800	Professor	07-123 456 800	test@xxxxxx.com	No. xx, Downing Street, London	Test
Selina Johnson	Female	30	selina.png	UK	English	England	123456801	Composer	07-123 456 801	test@xxxxxx.com	No. xx, Downing Street, London	Test

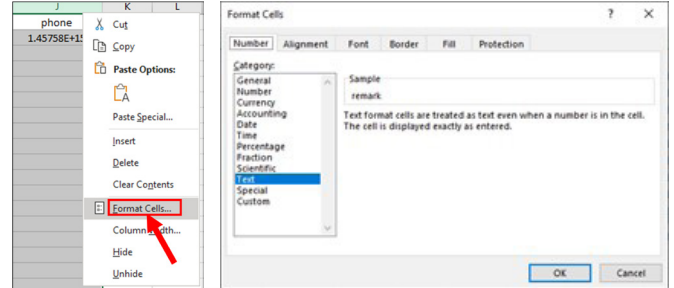

- Save the .csv file. Make sure the file is saved as CSV UTF-8 type.
- Copy the whole folder, including the face images and the "facemplate.csv", and paste it to your USB flash drive.
- Insert the USB flash drive into the USB port of your NVR.
- Click the **Edit** button of the group that you would like to create face profiles for.

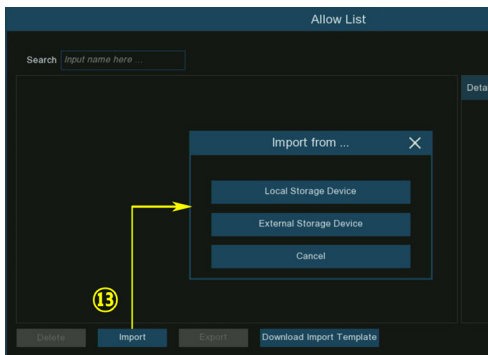

- From the Group window, click the **Import** button, then click the **External Storage Device** button.
- Find out and click on the "facemplate.csv" file from your USB flash drive, and then click OK.

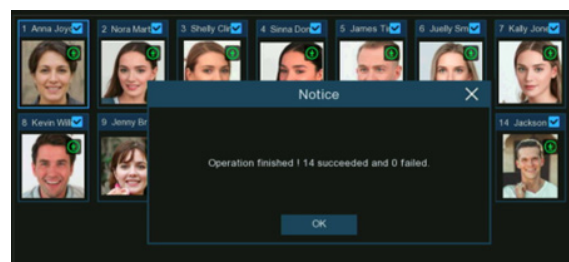
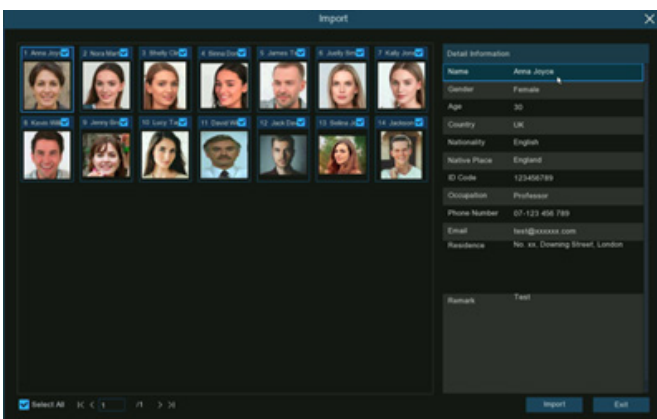

- The face profiles are shown here. Click **Import** button to import the face profiles into the NVR.

EN

5.4.2.2.4 - Edit Face Profiles

If you want to edit or delete a face profile, please proceed as below:

1. Click on the edit button of the group you want to edit
2. In the group edit page, you're able to execute below operations:

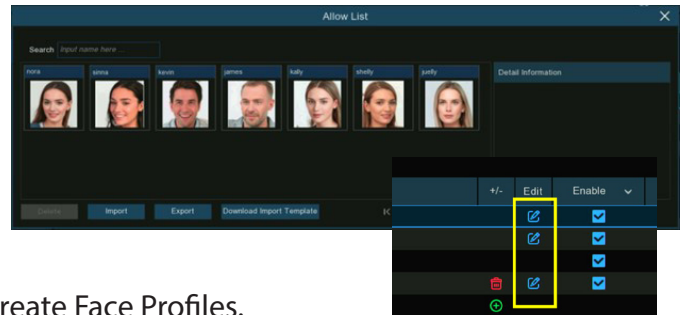

- **Import:** To import face images. View on 5.4.2.2.1. Create Face Profiles.
 - **Export:** To export face image(s) to external USB flash drive.
 - Click **Export** button directly to export all face images in this group.
 - Click on one of the face images, and then click **Export** button to export an individual image.
 - Click and hold the left button of your mouse, then drag the cursor to select multiple images, and then click **Export** button to export the selected images.
3. Move the mouse cursor upon the image you want to edit and then click left button of your mouse to select it. Click right button of your mouse to display a pop-up menu.

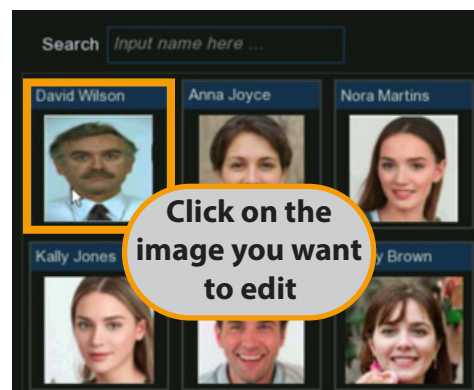
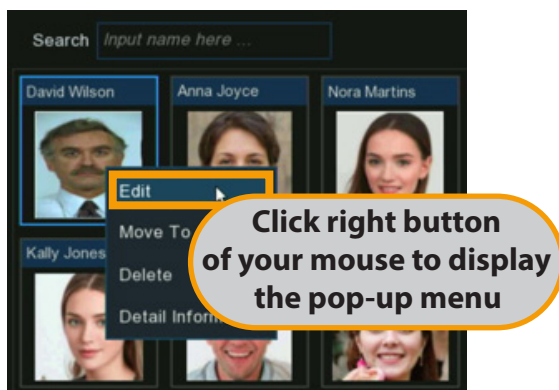

4. With the pop-up menu, you're able to:
 - **Edit:** Click to edit the face profile. Check how to edit the profile on 5.4.2.2.2. Create Individual Face Profile from External Storage Device.
 - **Move To:** Click to move the face to another group.

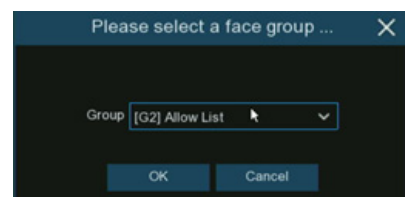

Choose the targeted group, and then click OK.

- **Delete:** To delete the select face profile.
- **Detail Information:** Click to view the details of the selected face profile.



5.4.2.3 - License Plate Management

You're able to create and manage the vehicle license profile (database) to classify different vehicles into different groups in order to quickly identify vehicles in remote and realize intelligent alarm beforehand.

EN

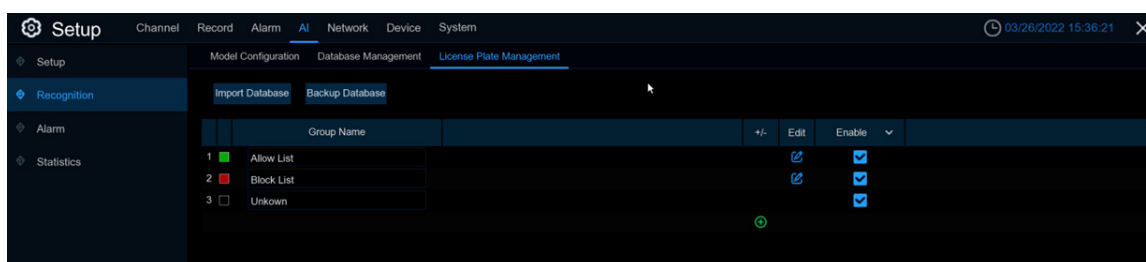

There are 3 default groups:

- **Allow List:** Mostly used to define a list of vehicles that are regarded as acceptable or trustworthy.
- **Block List:** Mostly used to define a list of vehicles that are regarded as unacceptable or untrustworthy and should be excluded or avoided.
- **Unknown:** All ungrouped vehicles will be identified as unknown vehicles.

You can click add button to create or click delete button to delete customized group.

If you want to make a backup of your database, use the **Backup Database** function to export it to your USB flash drive. The exported database can be imported to the same or another NVR by using **Import Database** function.

Tick the checkbox of **Enable** to enable the group. You would need to create vehicle license profiles (add license number) to the groups in order to sufficiently exert the identification effects.

NOTE: The maximum number to create vehicle license profiles in each group is 5,000.

5.4.2.3.1 - Create License Profiles from Local Storage Device

This section will show how to create vehicle profiles from license plate images that have been captured and stored on your NVR.

- 1 – Click the **Edit** button of the group that you would like to create vehicle license profiles for.

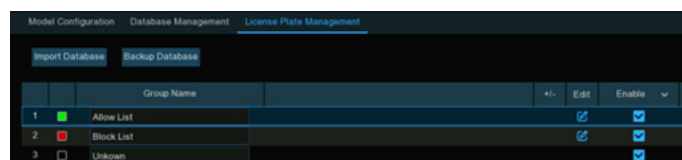

- 2 – Click the **Import from Local** button.

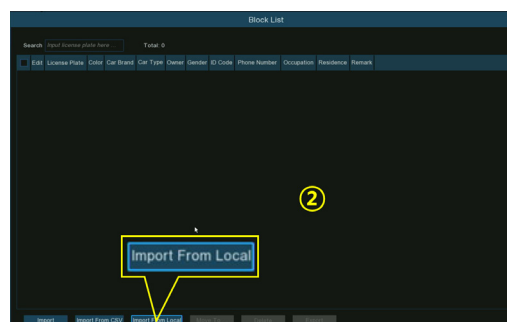

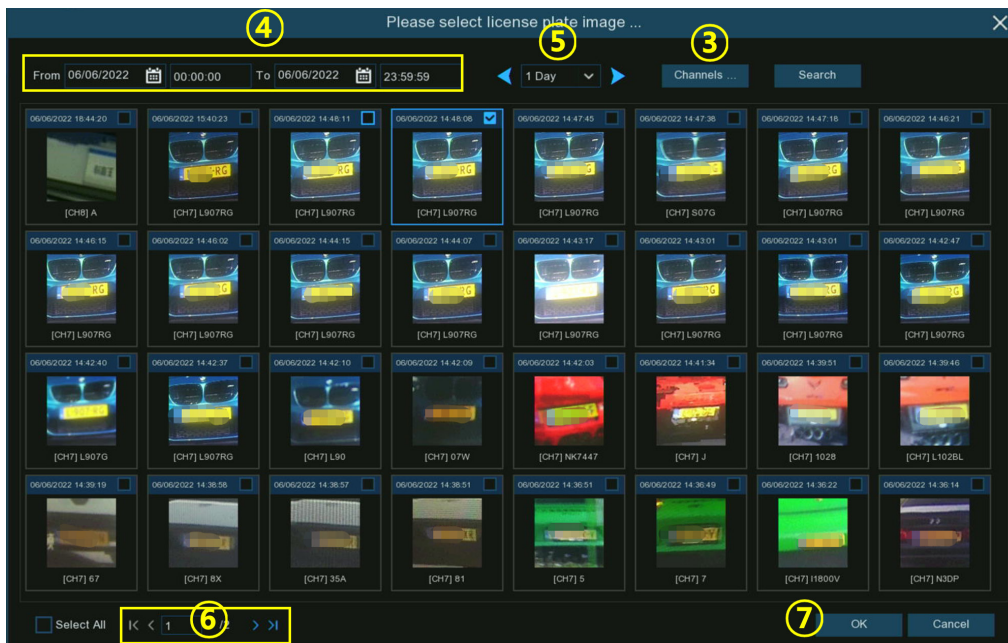

- 3 – **Channels:** All channels are set to search by default. You can specify the cameras you want to search on.
- 4 – Use the calendar to specify the date range.
- 5 – Choose the day duration, and then use the arrow buttons to quickly display license plate images from the previous or next day(s).
- 6 – The search result will be displayed in the face list automatically. Use the arrow buttons to display previous or next page of results.
- 7 – Tick the checkbox on the top right corner of the image to select the license plate images that you want to import, and then click OK button.

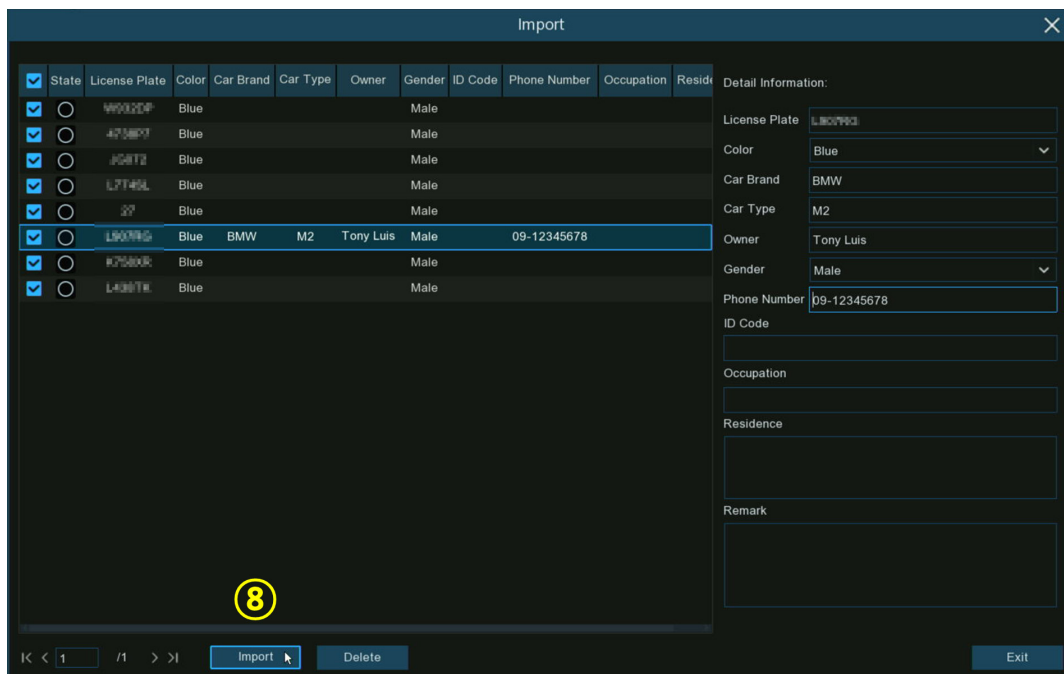

- 8 – Now you will see a list of license number. Click on one of the license numbers, the detailed information will be list on the right side. You're able to edit the information, including license number, color, brand, model of the vehicle, and the owner's profile. Click **Import** button after finishing the information input, the selected license numbers have been added.

5.4.2.3.2 - Create License Profiles Manually

This section will show how to create vehicle manually.

EN

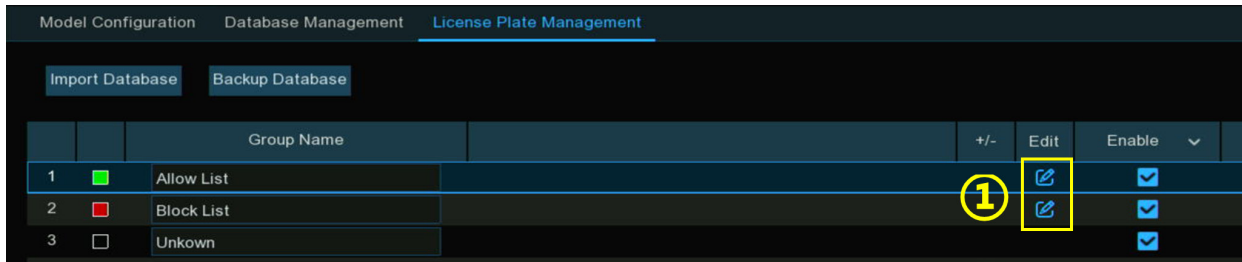

- 1 – Click the **Edit** button of the group that you would like to create vehicle license profiles for.
- 2 – Click the **Import** button.
- 3 – Edit the license profile, including number, color, brand, model/type of the vehicle, and the owner's information.
- 4 – Click setup button to configure the voice prompt for the person. View more on 5.3.9. Voice Prompts to learn how to configure this function.

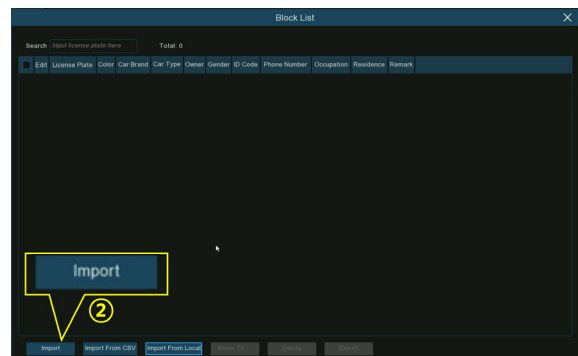

i NOTE: The voice file you import here takes effect only to this period. If you had set several periods of time, you would need to import voice file for each period.

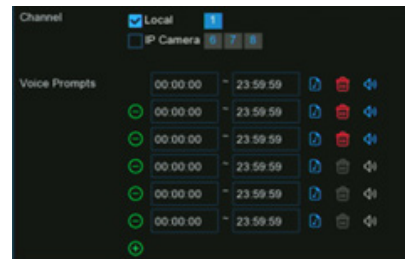

- 5 – Click setup button to configure the **Alarm Channel**. The system will alert when the license plate is detected and captured by the selected cameras.
- 6 – Click **Import** button after finishing the information input, click **Exit** to finish.

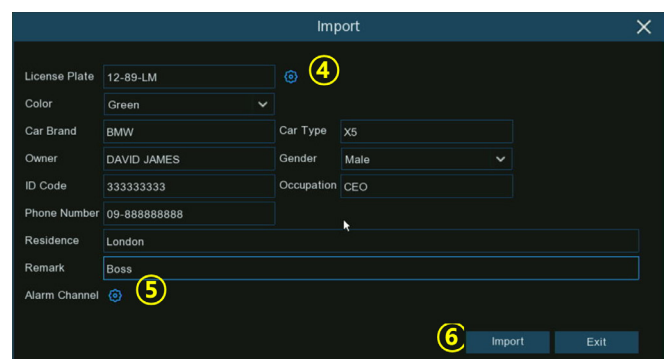

5.4.2.3.3 - Create Bulk License Profiles

If you want to create a batch of license profiles at once, please proceed as below:

1. Insert your USB flash drive into the USB port of the NVR.
2. Click the **Edit** button  of any one of groups where there is at least one vehicle license profile exists.



3. From the Group window, select at least one of the license profiles, and then click **Export** button.

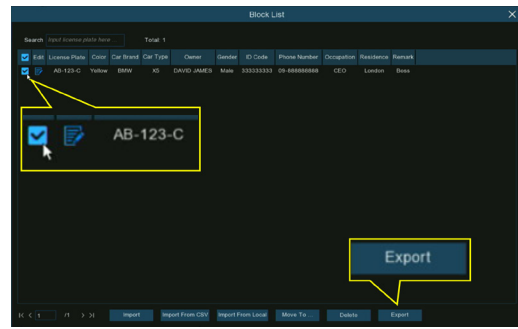

4. A ".csv" file will be exported and saved to your USB flash drive.
 - Click **OK** button.

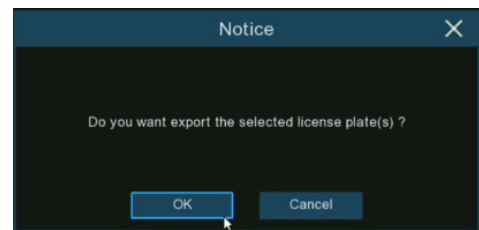

- Select the directory you want to save the file, and then Click **OK** button.

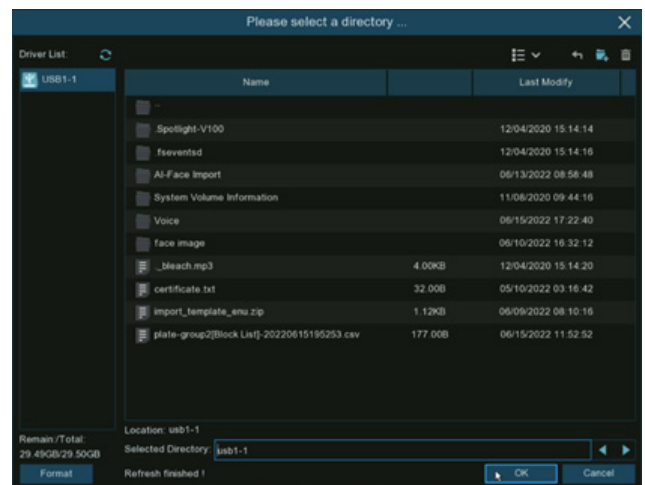

5. Double click on the exported ".csv" file to run it with excel in your PC. The content is shown as follows:

A	B	C	D	E	F	G	H	I	J	K
License Plate	Color	Car Brand	Car Type	Owner	Gender	ID Code	Phone Number	Occupation	Residence	Remark
AB-123-C	blue	BMW	X5	David James	male	1.23457E+17	09-788 788 788	CEO	No. 10, xxx Road, London	Boss

Columns

- **A:** License number of the vehicle
- **B:** Color of the vehicle
- **C:** Brand of the vehicle
- **D:** Type/model of the vehicle
- **E:** Name of the owner of the vehicle
- **F:** Gender of the owner of the vehicle
- **G:** ID number of the owner of the vehicle
- **H:** Phone number of the owner of the vehicle
- **I:** Occupation/Job/Career of the owner of the vehicle
- **J:** Residence address of the owner of the vehicle
- **K:** Remarks column

6. Edit the cells according to your actual conditions as illustrated as below:

License Plate	Color	Car Brand	Car Type	Owner	Gender	ID Code	Phone Number	Occupation	Residence	Remark
AB-123-2	blue	BMW	X5	Anna Joyce	Female	12345678911111	09-788 788 788	Professor	No. 10, xxx Road, London	
AB-123-3	yellow	Lamborghini	Huracan	Nora Martins	Female	12345678911111	09-788 788 789	Professor	No. 11, xxx Road, London	Boss
AB-123-4	black	Volkswagen	Bora	Shelly Clinton	Female	12345678911111	09-788 788 790	Editor	No. 12, xxx Road, London	
AB-123-5	green	Hyundai	Tucson	Sinna Donald	Female	12345678911111	09-788 788 791	Photographer	No. 13, xxx Road, London	
AB-123-6	black	Toyota	Highlander	James Timothy	Male	12345678911111	09-788 788 792	Director	No. 14, xxx Road, London	
AB-123-7	white	Honda	Accord	Juelly Smith	Female	12345678911111	09-788 788 793	Cashier	No. 15, xxx Road, London	
AB-123-8	black	Peugeot	4008	Kally Jones	Female	12345678911111	09-788 788 794	Reporter	No. 16, xxx Road, London	
AB-123-9	black	Chevrolet	Blazer	Kevin Williams	Male	12345678911111	09-788 788 795	Manager	No. 17, xxx Road, London	

i NOTE: If you input a number uninterruptedly more than 11 digits in a cell, the system will display the number in scientific notation, e.g., "1.23457E+11". If so, you would need to adjust the format of the column to be "Text".

Select the column (especially the column of ID code and phone number) and then click right button of your mouse. Click Format Cells... on the pop-up menu.

Choose Text, and then click OK button.

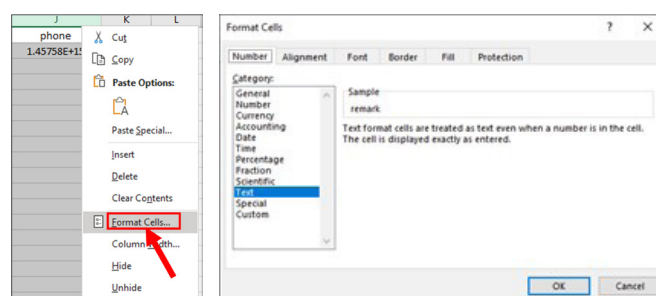

7. Save the ".csv" file. Make sure the file is saved as CSV UTF-8 type.
8. Copy and paste the ".csv" file to your USB flash drive.
9. Insert the USB flash drive into the USB port of your NVR.
10. Click the **Edit** button of the group that you would like to import vehicle license profiles for.
11. Click **Import from CSV** button, and then choose the ".csv" file from USB flash drive and click **OK**.

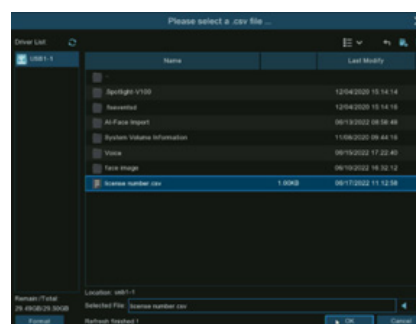
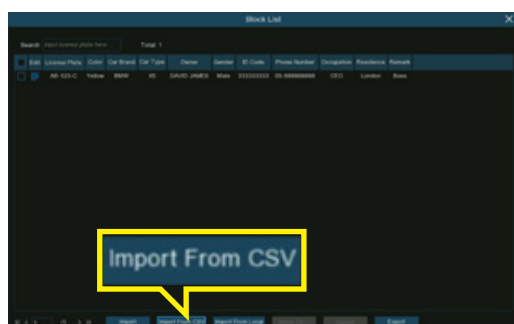
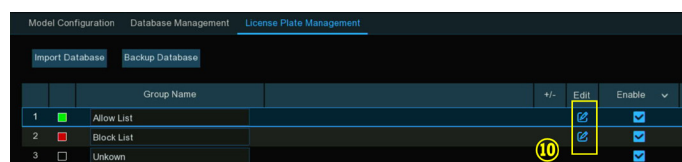

12. Now you can see a list of license number as illustrated below. Click on one of the license numbers, the detailed information will be list on the right side. Click **Import** button to import the license profiles into the NVR and click **Exit** to finish.

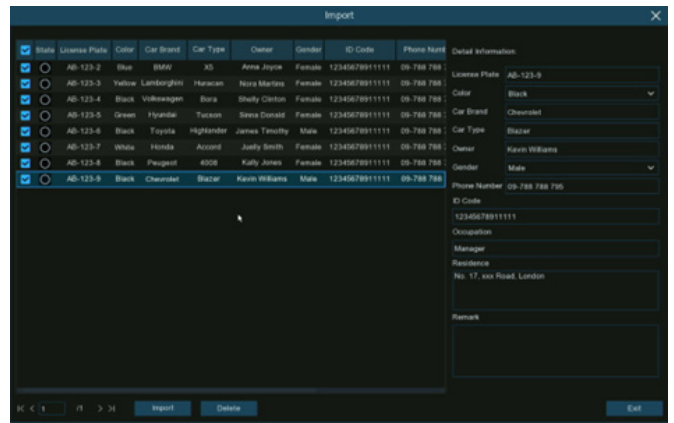

5.4.2.3.4 - Edit License Profiles

If you want to edit or delete a face profile, please proceed as below:

1. Click the **Edit** button of the group that you would like to edit the vehicle license profiles for.



2. If you want to modify the information for a license profile, click the edit button in front of the license number.

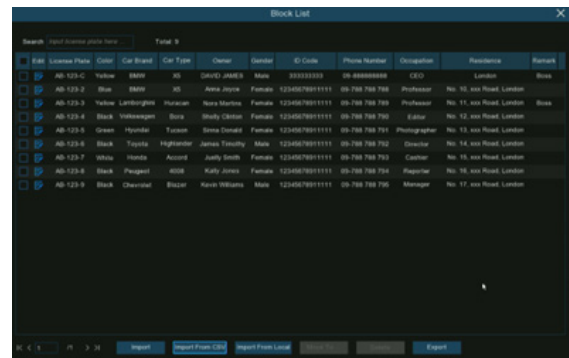

Modify the information on the Modify window accordingly, and then click **Modify** button to apply.

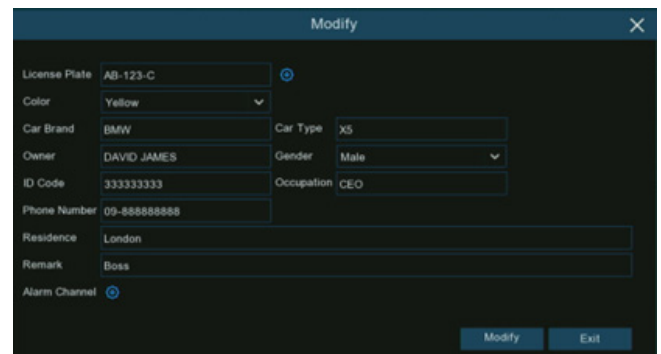

- If you want to delete, move or export license profile(s), please proceed as below:

Tick the checkbox to select the license profile firstly:

- If you want to delete, click **Delete** button and confirm to delete the selected license profile(s).
- If you want to move the profiles to another group, click **Move To...** button, and then select the targeted group.
- If you want to export the profiles to USB flash drive, click **Export** button to save a ".csv" file.

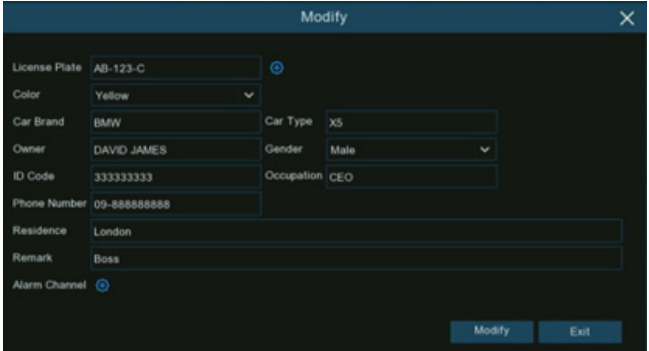

License Plate	AB-123-C		
Color	Yellow		
Car Brand	BMW	Car Type	X5
Owner	DAVID JAMES	Gender	Male
ID Code	33333333	Occupation	CEO
Phone Number	09-88888888		
Residence	London		
Remark	Boss		
Alarm Channel			

5.4.3 - AI Alarm Settings

In this section, you can configure the alarm actions when event occurs.

5.4.3.1 - FR (Face Recognition) Alarm Settings

To configure alarm actions for different groups when faces detected.

	Group Name	Enable Alarm	Policy	Similarity	Alarm	Alarm Schedule	Alarm Channel
1	Allow List	<input checked="" type="checkbox"/>	Allow	≥ 70	%	<input checked="" type="checkbox"/>	<input checked="" type="checkbox"/>
2	Block List	<input checked="" type="checkbox"/>	Deny	≥ 70	%	<input checked="" type="checkbox"/>	<input checked="" type="checkbox"/>
3	Stranger	<input checked="" type="checkbox"/>	Stranger	< 70	%	<input checked="" type="checkbox"/>	<input checked="" type="checkbox"/>
4	Group 1	<input checked="" type="checkbox"/>	Allow	≥ 70	%	<input checked="" type="checkbox"/>	<input checked="" type="checkbox"/>
5	Group 2	<input checked="" type="checkbox"/>	Allow	≥ 70	%	<input checked="" type="checkbox"/>	<input checked="" type="checkbox"/>
6	Group 3	<input checked="" type="checkbox"/>	Allow	≥ 70	%	<input checked="" type="checkbox"/>	<input checked="" type="checkbox"/>

Enable Alarm: Tick the checkbox of the group(s) you want to enable alarm function. If the checkbox isn't enabled, no actions specified for the group such as alarm notifications will be actioned by your NVR. It is strongly recommended that the "Enable" checkbox for the "Stranger" group remains ticked. This allows your NVR to save the images of every single face detected, including those that do not match any existing face profiles to the database. You can use these captured face images later to create or improve face profiles in the Allow List & Block List groups.

Policy: This setting is non-configurable for the three preset face groups. If a customized group has been created, you can set the policy of your customized group to either **Allow** or **Deny**.

Similarity: Set how closely, in percentage terms, the detected face must match a face profile in the group to be considered a recognized match. The default threshold is 70%. A higher percentage of similarity will result in fewer false recognition results.

Alarm: Click the button setup to specify the group actions to be taken by your NVR when a face recognition event has occurred.

- **Buzzer:** When alarm event is detected, you can enable the NVR's buzzer to alert you for a predetermined amount of time. Click the drop-down menu to select a time.
- **Alarm Out:** If your NVR or IP camera supports to connect external replay output devices, the system can send an alert message to the external alarm devices. Click button, to choose the external alarm devices:

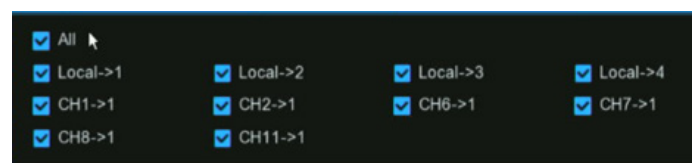
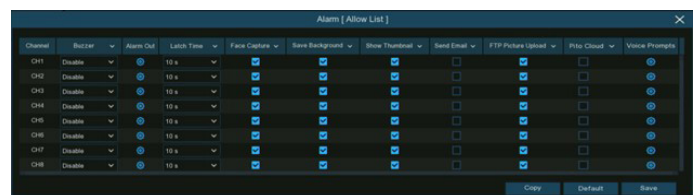

Local: External alarm devices connected to the NVR.

CHx->1: External alarm devices connected to IP cameras.

Latch Time: To configure the external alarm time when the detection is triggered.

Face Capture: Configure whether the snapshot of the recognized face will be saved to the face database on your NVR. Leave this option enabled so more facial images can be added to profiles later to improve the accuracy of face recognition.

Save Background: Whether the snapshot of the background will be saved together with the face image. It is recommended to leave this option enabled.

Show Thumbnail: Whether to generate a facial recognition event notification that includes a snapshot of the recognized face via the Alarm Notification Panel in Live View mode. Disabling this option will stop facial recognition events from appearing in the Alarm Notification Panel.

Send Email: An email alert will be sent when alarm event is detected. Click the checkbox if you want to disable this.

FTP Picture Upload: Click the checkbox to copy snapshots to your ftp server when the detection is triggered.

Picture to Cloud: Click the checkbox to copy snapshots to the cloud via Dropbox or Google Drive when the detection is triggered.

Voice Prompts: If your NVR connects with a speaker, you can select a customized alert voice when the detection is triggered. See how to add customized alert voice on 5.3.9 Voice Prompts.

Copy: Use the **Copy** function to apply all settings to the other connected cameras.

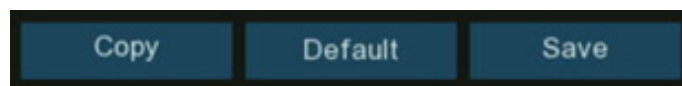

Default: Click **Default** to revert to default settings.

Save: Click **Save** to save settings.

Alarm Schedule: Click setup button to configure the schedule of when actions specified for the group will take effect.

To set the schedule, choose one channel then drag the cursor to mark the slots. The sky-blue blocks in the time slots will be active for alarm actions. The schedule is valid only for the selected channel each time when you set. If you want to use the same schedule for other channels, use **Copy** function. Click **Save** to save your settings.

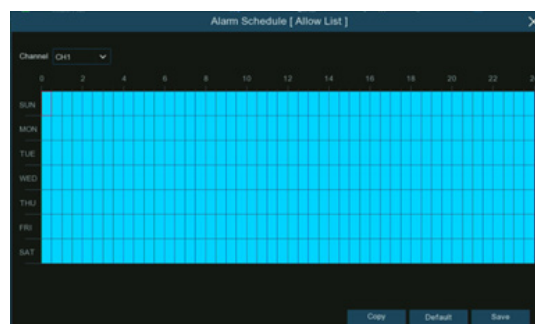

Alarm Channel: Click setup button to configure the **Alarm Channel**. The NVR will alert when faces are detected and captured by the selected cameras.

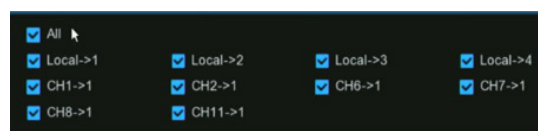

5.4.3.2 - AD (Attribution Detection) Alarm Settings

Attribute detection is a function to detect people's facial features and send an alarm according to the settings.

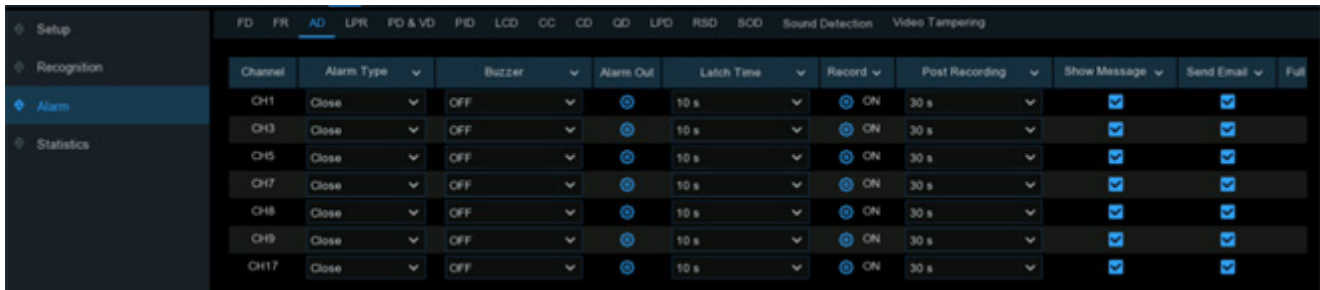

Alarm Type: Select an alarm trigger condition:

- **No Mask:** When a person is detected not wearing a face mask, the NVR will send an automated alert
- **Wear Mask:** When a person is detected wearing a face mask, the NVR will send an automated alert
- **Close:** The face mask detection will be disabled.

NOTE: To enable the face mask detection function, you need to enable the Face Detection and Face Attribute function on the camera. If want to get the alert in real-time, you would need to set the snap mode to be Real-time. view more on 5.4.1.1. FD (Face Detection).

Buzzer: When alarm event is detected, you can enable the NVR's buzzer to alert you for a predetermined amount of time. Click the drop-down menu to select a time.

Alarm Out: If your NVR or IP camera supports to connect external replay output devices, the system can send an alert message to the external alarm devices. Click button, to choose the external alarm devices:

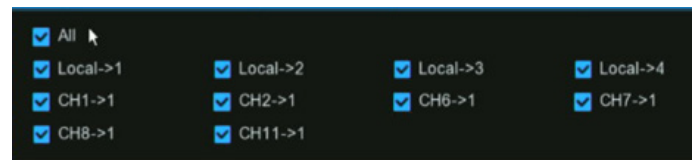

Local: External alarm devices connected to the NVR.

CHx->1: External alarm devices connected to IP cameras.

Latch Time: To configure the external alarm time when the detection is triggered.

Record: This option instructs your NVR to trigger additional cameras to start recording when motion is detected. Click the drop-down arrow to choose all channels to be recorded or not.

Click button, click the **Record Channel** checkbox to enable recording. Click the checkbox in front of the channel number to select all channels or click on the individual camera number that you want to trigger for recording.

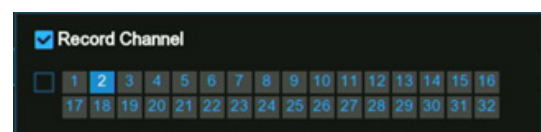

Post Recording: This option instructs your NVR to record for a set time after an event has occurred. For most instances, the default selection will be suitable, however, you can change this if you wish.

Show Message: When the detection is triggered, the alarm icon will appear on screen.

Send Email: An email alert will be sent when alarm event is detected. Click the checkbox if you want to disable this.

Full Screen: Click the checkbox to view the camera full-screen in Live View mode when the detection is triggered.

Voice Prompts: If your NVR connects with a speaker, you can select a customized alert voice when the detection is triggered. See how to add customized alert voice on 5.3.9 Voice Prompts.

Default: Click **Default** to revert to default settings.

Copy: Use the **Copy** function to apply all settings to the other connected cameras.

Apply: Click **Apply** to save settings.

5.4.3.3 - LPR (License Plate Recognition) Alarm Settings

To configure alarm actions for different groups when vehicle license plates detected.

Channel	Alarm Type	Buzzer	Alarm Out	Latch Time	Record	Post Recording	Show Message	Send Email	Full
CH1	Close	OFF	<input checked="" type="checkbox"/>	10 s	<input checked="" type="checkbox"/> ON	30 s	<input checked="" type="checkbox"/>	<input checked="" type="checkbox"/>	<input checked="" type="checkbox"/>
CH3	Close	OFF	<input checked="" type="checkbox"/>	10 s	<input checked="" type="checkbox"/> ON	30 s	<input checked="" type="checkbox"/>	<input checked="" type="checkbox"/>	<input checked="" type="checkbox"/>
CH5	Close	OFF	<input checked="" type="checkbox"/>	10 s	<input checked="" type="checkbox"/> ON	30 s	<input checked="" type="checkbox"/>	<input checked="" type="checkbox"/>	<input checked="" type="checkbox"/>
CH7	Close	OFF	<input checked="" type="checkbox"/>	10 s	<input checked="" type="checkbox"/> ON	30 s	<input checked="" type="checkbox"/>	<input checked="" type="checkbox"/>	<input checked="" type="checkbox"/>
CH8	Close	OFF	<input checked="" type="checkbox"/>	10 s	<input checked="" type="checkbox"/> ON	30 s	<input checked="" type="checkbox"/>	<input checked="" type="checkbox"/>	<input checked="" type="checkbox"/>
CH9	Close	OFF	<input checked="" type="checkbox"/>	10 s	<input checked="" type="checkbox"/> ON	30 s	<input checked="" type="checkbox"/>	<input checked="" type="checkbox"/>	<input checked="" type="checkbox"/>
CH17	Close	OFF	<input checked="" type="checkbox"/>	10 s	<input checked="" type="checkbox"/> ON	30 s	<input checked="" type="checkbox"/>	<input checked="" type="checkbox"/>	<input checked="" type="checkbox"/>

Enable Alarm: Tick the checkbox of the group(s) you want to enable alarm function. If the checkbox isn't enabled, no actions specified for the group such as alarm notifications will be actioned by your NVR. It is strongly recommended that the **Enable** checkbox for the **Unknown** group remains ticked. This allows your NVR to save the images of every single license plate detected, including those that do not match any existing license profiles to the database. You can use these captured license plate images later to create or improve license profiles in the Allow List & Block List groups.

Policy: This setting is non-configurable for the three preset license groups. If a customized group has been created, you can set the policy of your customized group to either **Allow** or **Deny**.

Fault Tolerance: Varies in image resolution, light strength, camera angles, moving speed of the vehicle and etc., character(s) in the license plate number might be failed to recognize. Set the Fault Tolerance that how many characters the detected license allowed to be different from the license number saved in the group. If the number of difference characters between the detected license number and a license profile in the group is no more than the set value, the detected license will be considered a recognized match.

NOTE: Only English letters and digit numbers will be recognized by the system, special symbols, like underline , virgule /, hyphen -, will be excluded from being recognized. Please set the Fault Tolerance accordingly if you have input special symbols in the license number when creating a license profile.

Recognized License Number	Number in License Profile	Fault Tolerance	Recognition Result
AB123C	AB-123-C	≤2 characters	True
AB123C	AB-123-C	≤0 or 1 character	False
A8I23C	AB123C	≤2 characters	True
A8I23C	AB123C	≤0 or 1 character	False
B594SB	B734KB	≤3 characters	True
B594SB	B734KB	≤2 character	False
AB132C	AB123C	≤2 characters	True
AB123C	AB123C	≤0 or 1 character	False

Alarm: Click the button **setup** to specify the group actions to be taken by your NVR when a face recognition event has occurred.

- **Buzzer:** When alarm event is detected, you can enable the NVR's buzzer to alert you for a predetermined amount of time. Click the drop-down menu to select a time.
- **Alarm Out:** If your NVR or IP camera supports to connect external replay output devices, the system can send an alert message to the external alarm devices. Click **button**, to choose the external alarm devices:



Local: External alarm devices connected to the NVR.

CHx->1: External alarm devices connected to IP cameras.

Latch Time: To configure the external alarm time when the detection is triggered.

License Plate Capture: Configure whether the snapshot of the recognized license plate will be saved to the license database on your NVR. Leave this option enabled so more license plate images can be added to profiles later to improve the accuracy of license plate recognition.

Save Background: Whether the snapshot of the background will be saved together with the license plate image. It is recommended to leave this option enabled.

Show Thumbnail: Whether to generate a license plate recognition event notification that includes a snapshot of the recognized license plate via the Alarm Notification Panel in Live View mode. Disabling this option will stop license plate recognition events from appearing in the Alarm Notification Panel.

Send Email: An email alert will be sent when alarm event is detected. Click the checkbox if you want to disable this.

FTP Picture Upload: Click the checkbox to copy snapshots to your ftp server when the detection is triggered.

Picture to Cloud: Click the checkbox to copy snapshots to the cloud via Dropbox or Google Drive when the detection is triggered.

Voice Prompts: If your NVR connects with a speaker, you can select a customized alert voice when the detection is triggered. See how to add customized alert voice on 5.3.9 Voice Prompts.

Copy: Use the **Copy** function to apply all settings to the other connected cameras.

Default: Click **Default** to revert to default settings.

Save: Click **Save** to save settings.

Alarm Schedule: Click setup button to configure the schedule of when actions specified for the group will take effect.

To set the schedule, choose one channel then drag the cursor to mark the slots. The sky-blue blocks in the time slots will be active for alarm actions. The schedule is valid only for the selected channel each time when you set. If you want to use the same schedule for other channels, use Copy function. Click Save to save your settings.

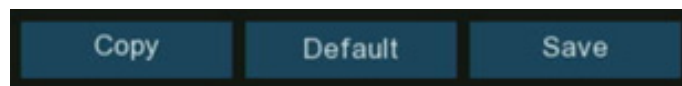

EN

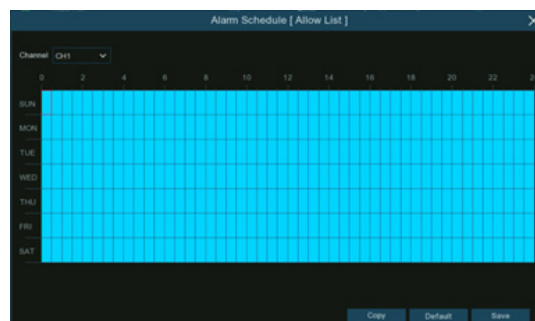

Alarm Channel: Click setup button to configure the Alarm Channel. The NVR will alert when faces are detected and captured by the selected cameras.

5.4.3.4 - PD & VD (Human & Vehicle Detection) Alarm Settings

To configure alarm actions when human beings and/or vehicles are detected.

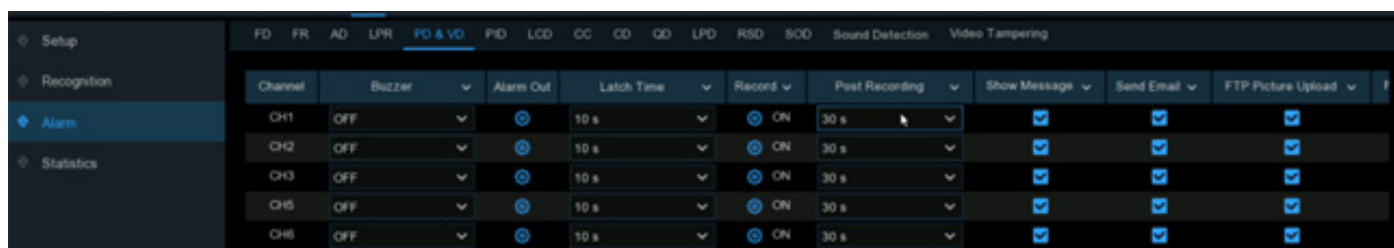

Buzzer: When alarm event is detected, you can enable the NVR's buzzer to alert you for a predetermined amount of time. Click the drop-down menu to select a time.

Alarm Out: If your NVR or IP camera supports to connect external replay output devices, the system can send an alert message to the external alarm devices. Click button, to choose the external alarm devices:

Local: External alarm devices connected to the NVR.

CHx->1: External alarm devices connected to IP cameras.

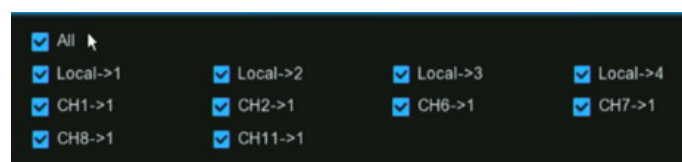

Latch Time: To configure the external alarm time when the detection is triggered.

Record: This option instructs your NVR to trigger additional cameras to start recording when motion is detected. Click the drop-down arrow to choose all channels to be recorded or not.

Click button, click the **Record Channel** checkbox to enable recording. Click the checkbox in front of the channel number to select all channels or click on the individual camera number that you want to trigger for recording.

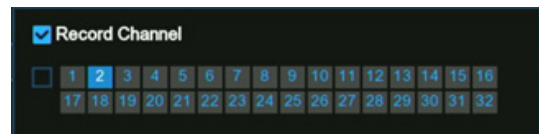

Post Recording: This option instructs your NVR to record for a set time after an event has occurred. For most instances, the default selection will be suitable, however, you can change this if you wish.

Show Message: When the detection is triggered, the alarm icon will appear on screen.

Send Email: An email alert will be sent when alarm event is detected. Click the checkbox if you want to disable this.

FTP Picture Upload: Click the checkbox to copy snapshots to your ftp server when the detection is triggered.

FTP Video Upload: Click the checkbox to copy videos to your ftp server when the detection is triggered.

Picture to Cloud: Click the checkbox to copy snapshots to the cloud via Dropbox or Google Drive when the detection is triggered.

Video to Cloud: Click the checkbox to copy videos to the cloud via Dropbox or Google Drive when the detection is triggered.

Full Screen: Click the checkbox to view the camera full-screen in Live View mode when the detection is triggered.

Voice Prompts: If your NVR connects with a speaker, you can select a customized alert voice when the detection is triggered. See how to add customized alert voice on 5.3.9 Voice Prompts.

Copy: Use the **Copy** function to apply all settings to the other connected cameras.

Default: Click **Default** to revert to default settings.

Apply: Click **Apply** to save settings.

5.4.3.5 - FD/PID/LCD/CC/CD/QD/LPD/RSD/SOD/Sound Detection/Video Tampering Alarm Settings

The setting method to configure alarm actions is same for FD, PID, LCD, CC, CD, QD, LPD, RSD, SOD, Sound Detection and Video Tampering.

NOTE: LPD (License Plate Detection) is different from LPR (License Plate Recognition). LPD emphasizes on "detection", which will take actions when license plates are detected by the camera, no matter the license plates are documented in the database or not. LPR emphasizes on "recognition" and triggers the alarm actions with recognition result.

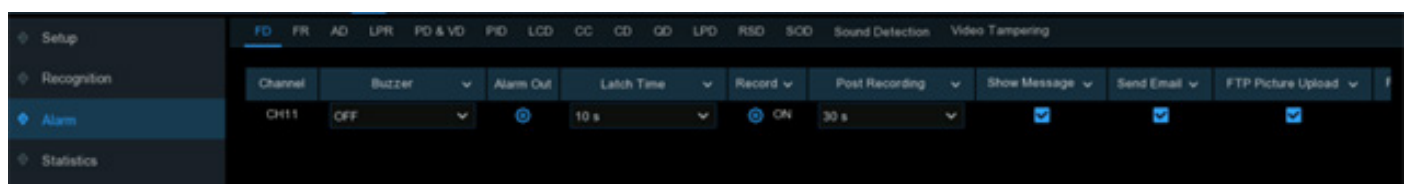

Buzzer: When alarm event is detected, you can enable the NVR's buzzer to alert you for a predetermined amount of time. Click the drop-down menu to select a time.

Alarm Out: If your NVR or IP camera supports to connect external replay output devices, the system can send an alert message to the external alarm devices. Click  button, to choose the external alarm devices:

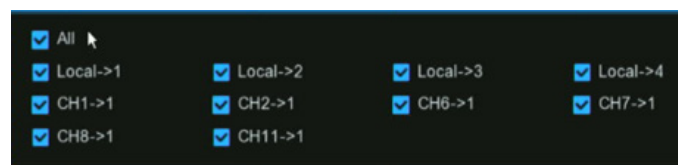

Local: External alarm devices connected to the NVR.

CHx->1: External alarm devices connected to IP cameras.

Latch Time: To configure the external alarm time when the detection is triggered.

Record: This option instructs your NVR to trigger additional cameras to start recording when motion is detected. Click the drop-down arrow to choose all channels to be recorded or not.

Click  button, click the **Record Channel** checkbox to enable recording. Click the checkbox in front of the channel number to select all channels or click on the individual camera number that you want to trigger for recording.

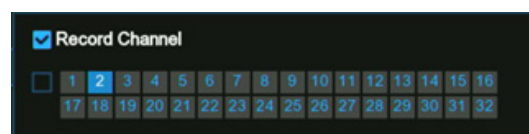

Post Recording: This option instructs your NVR to record for a set time after an event has occurred. For most instances, the default selection will be suitable, however, you can change this if you wish.

Show Message: When the detection is triggered, the alarm icon  will appear on screen.

Send Email: An email alert will be sent when alarm event is detected. Click the checkbox if you want to disable this.

FTP Picture Upload: Click the checkbox to copy snapshots to your ftp server when the detection is triggered.

FTP Video Upload: Click the checkbox to copy videos to your ftp server when the detection is triggered.

Picture to Cloud: Click the checkbox to copy snapshots to the cloud via Dropbox or Google Drive when the detection is triggered.

Video to Cloud: Click the checkbox to copy videos to the cloud via Dropbox or Google Drive when the detection is triggered.

Full Screen: Click the checkbox to view the camera full-screen in Live View mode when the detection is triggered.

Voice Prompts: If your NVR connects with a speaker, you can select a customized alert voice when the detection is triggered. See how to add customized alert voice on 5.3.9 Voice Prompts.

Copy: Use the **Copy** function to apply all settings to the other connected cameras.

Default: Click **Default** to revert to default settings.

Apply: Click **Apply** to save settings.

5.4.4 - Statistics

Your NVR can retrieve and present statistical data relating to the detection of objects when related AI detection is enabled on the camera.



5.4.4.1 - FR (Face Recognition) Statistics

Your NVR can retrieve and present statistical data relating to the detection of faces when the Face Recognition is enabled on the camera. The bar chart displays the number of faces that were detected during a particular time period while the pie chart displays the percentage share and frequency of detected faces belonging to each group.

Groups: Select the groups from which the face recognition data is obtained. By default, all groups have been selected.

Channels: Select the channels from which the face recognition data is obtained. By default, all channels have been selected.

Day/Week/Month/Quarter/Year: Click the drop-down menu to select the time period from which the face recognition data is obtained.

Calendar: Change the start date of the selected time period, click or button to move to last or next period.

Export: Export the facial recognition data for the selected time period to a USB flash drive. The file will be saved as a *.CSV file. You can open the file in Excel (or similar software) to further analyze the data.

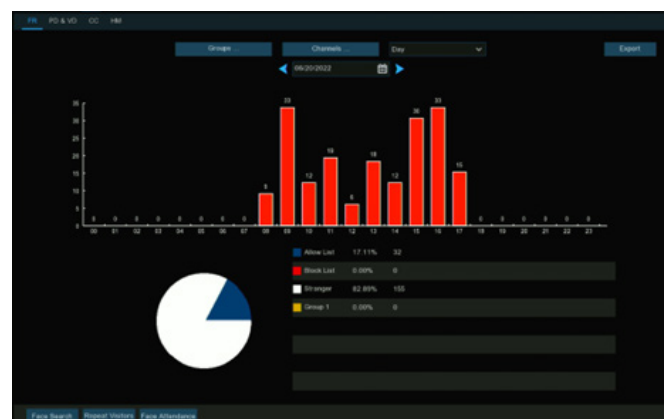

5.4.4.2 - PD & VD (Human & Vehicle) Statistics

Your NVR can retrieve and present statistical data relating to the detection of objects when the Human & Vehicle video analytic is enabled on the camera. The bar chart displays the number of humans and/or vehicles that were detected during a particular time.

AI: Click on the button to select the detection type(s) from which the human & vehicle detection data is obtained. By default, all types have been selected.

Channels: Select the channels from which the human & vehicle detection data is obtained. By default, all channels have been selected.

Day/Week/Month/Quarter/Year: Click the drop-down menu to select the time period from which human & vehicle detection data is obtained.

Calendar: Change the start date of the selected time period, click ◀ or ▶ button to move to last or next period.

Export: Export the facial recognition data for the selected time period to a USB flash drive. The file will be saved as a *.CSV file. You can open the file in Excel (or similar software) to further analyze the data.

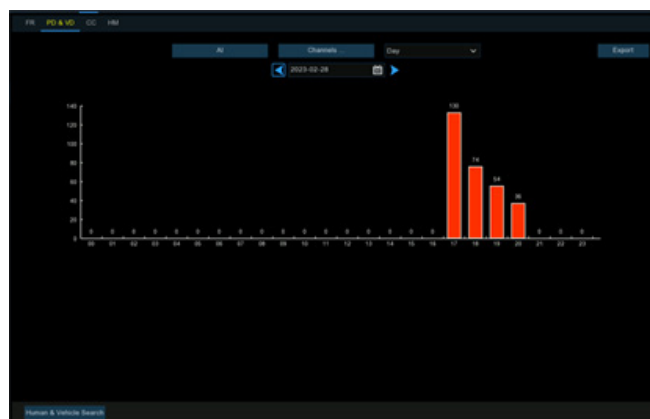

5.4.4.3 - PD & VD (Human & Vehicle) Statistics

Your NVR can retrieve and present statistical data relating to the detection of objects when the Human & Vehicle video analytic is enabled on the camera. The bar chart displays the number of humans and/or vehicles that were detected during a particular time.

1. Choose the Channel & Date you want to search.
2. Choose the Cross Type: Cross In or Cross Out.
3. Choose the Detection Type from Motion, Person, Motor Vehicle or Non-motor Vehicle.
4. Click Search button, the result will be displayed in column chart as default. You can click Line Chart to change its display mode.
5. The statistical data is searched and displayed a daily report by default. You can change the Report Type to choose a Weekly, Monthly or Annual report, and then click Search again.
6. Click Export button if you want to export the statistical data to USB flash drive. The file will be saved as a *.CSV file. You can open the file in Excel (or similar software) to further analyze the data.

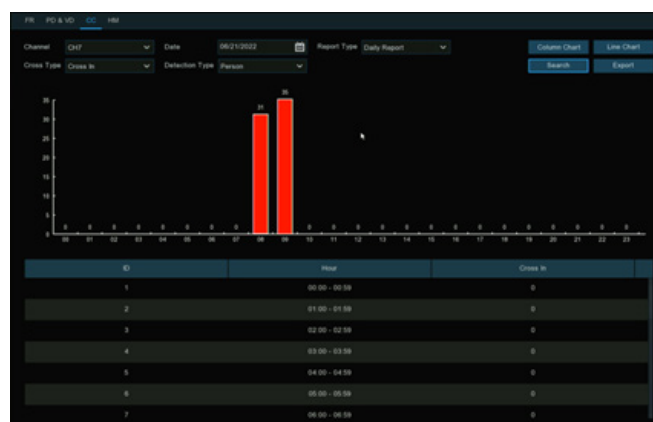

5.4.4.4 - HM (Heat Map) Statistics

Your NVR can retrieve and present statistical data relating to the detection of objects when the Heat Map video analytic is enabled on the camera. The color map gives you a visual display showing the area and frequency of motion detected. Warm colors represent high frequency and cool colors represent low frequency.

Channel: Select the channel from which the heat map statistic is obtained.

Report Type: Select daily, weekly, monthly or annual.

Date: Select the relevant date.

Start/End Hour: Select the relevant start and end hours.

Click **Search** to display the heat map statistic.

The Spatial Density Color represents the frequency of motion detected.

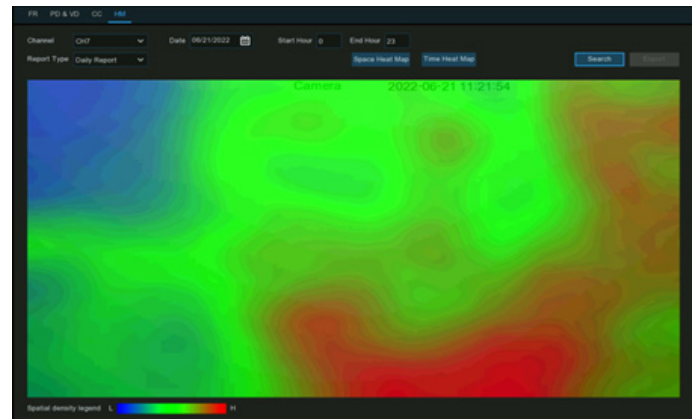

5.5 - Network

This menu allows you to configure network parameters

EN

5.5.1 - General Settings

To configure the network connection parameters here.

5.5.1.1 - General

To configure the network connection parameters here.

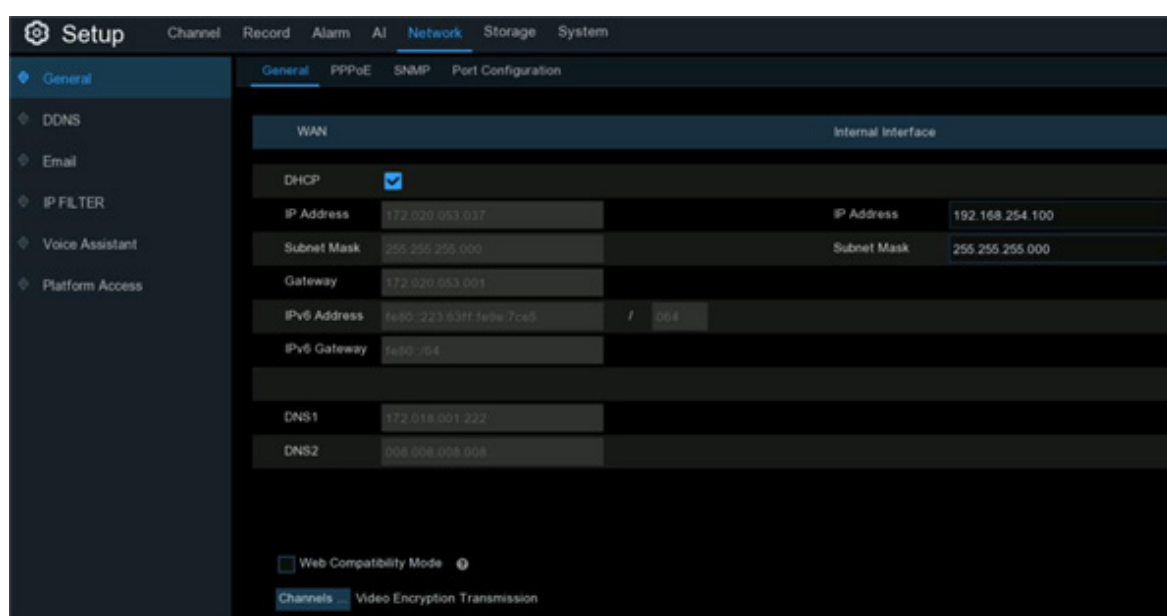

If you connect to a router which allows to use DHCP (Dynamic Host Configuration Protocol), please tick the checkbox of **DHCP**. The router will assign automatically all the network parameters for your NVR.

When disabling DHCP, the following options can be changed (this is for advanced users only):

IP Address: The IP address identifies the NVR in the network. It consists of four groups of numbers between 0 to 255, separated by periods. For example, "192.168.001.100".

Subnet Mask: This allows the flow of network traffic between hosts to be segregated based on a network configuration. A typical address might be "255.255.255.0" or something similar.

Gateway: This allows your NVR to connect to the internet and is typically the same IP address as your modem or router. The format of the **Gateway** address is the same as the **IP Address**. For example, "192.168.001.001".

DNS1/DNS2: Input the DNS settings for your internet service provider. DNS1 is the primary DNS server and DNS2 is a backup DNS server. Usually, it should be enough just to enter the DNS1 server address.

IPv6 Address: Input the IPv6 IP address if your network service supports IPv6. It consists of eight groups of characters between 0 to FFFF, separated by periods. For example, "ABCD:EF01:2345:6789:ABCD:EF01:2345:6789".

Web Compatibility Mode: If you are failed to login the NVR webpage with https protocol, enable the compatibility mode and try again. Otherwise, keep it disabled.

If your NVR comes with PoE ports, you will see the **Internal Interface** as shown:

PoE DHCP Server: Tick the checkbox to enable DHCP service. It will automatically assign an IP address to each IP camera connected to the PoE ports.

IP Address: Set the IP address for the internal PoE router. Leave this on the default setting.

Subnet Mask: Leave this on the default setting.

If the device is non-POE and supports dual LAN ports, you can see the following internal GUI:

After manually setting the IP address and subnet mask of the LAN port, you can add cameras of different network segments to the same device through the LAN port.

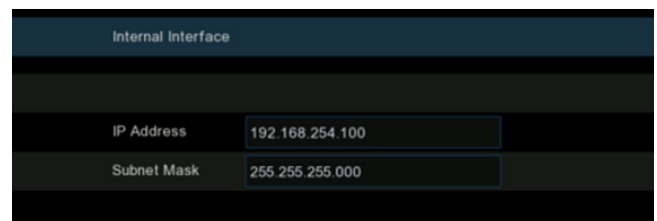
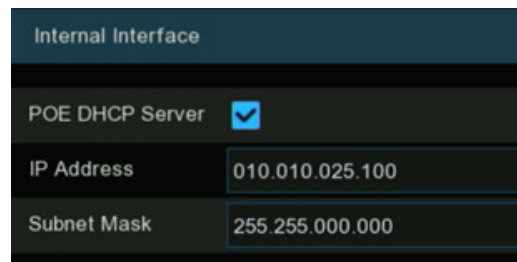

5.5.1.2 - PPPoE Settings

This is a protocol that allows the NVR to connect to the network more directly via DSL modem.

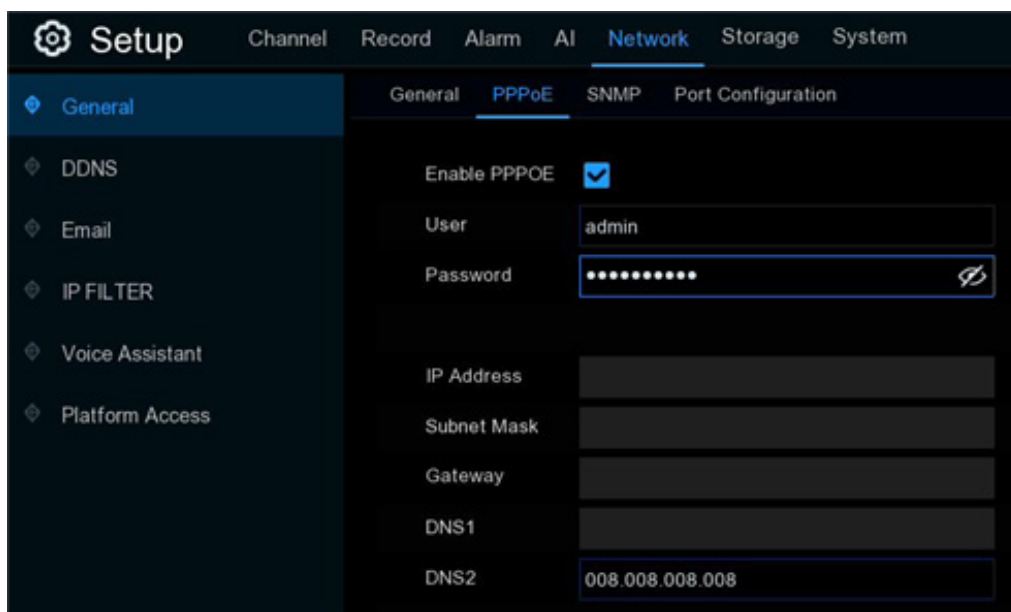

Tick the checkbox of the "Enable PPPOE", and then enter the User name & Password of the PPPoE you got from your ISP.

Click **Apply** to save, system will reboot to active the PPPoE setting.

5.5.1.3 - SNMP

SNMP (Simple Network Management Protocol) is an Internet Standard protocol for collecting and organizing information about managed devices on IP networks and for modifying that information to change device behaviour.

EN

With the SNMP, you are allowed to connected the NVR with 3rd party network management platform and acquire the NVR information, such as firmware version number, device type, resolution, frame rate, and etc.

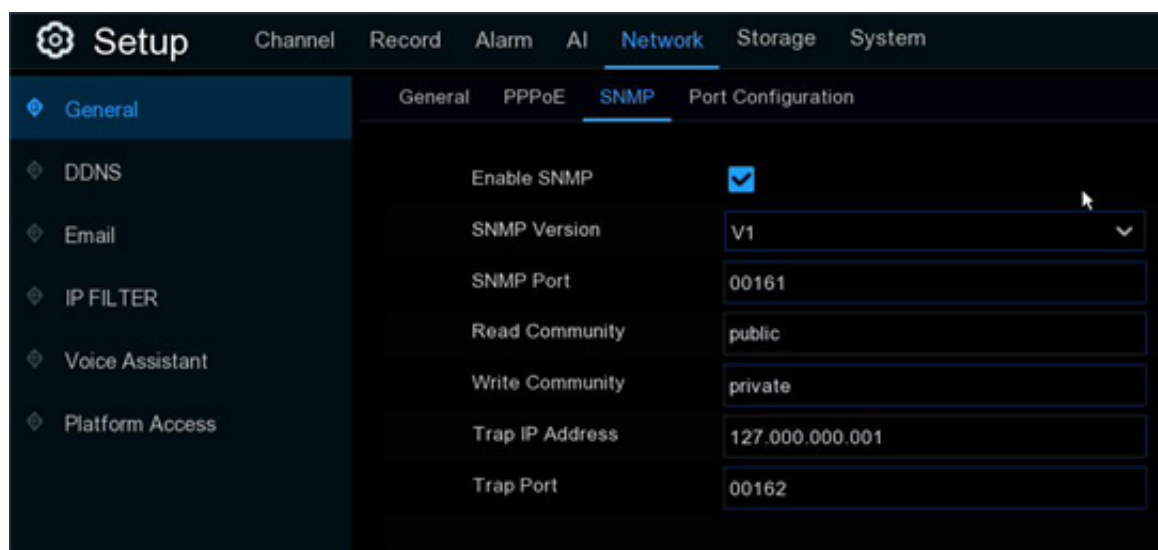

5.5.1.4 - Wireless Connection

If you have a compatible Wi-Fi dongle connected to an available USB port on your NVR, the Wi-Fi tab will appear. This gives you the flexibility of placing your NVR in a different location, without having to be physically connected to your router or modem.

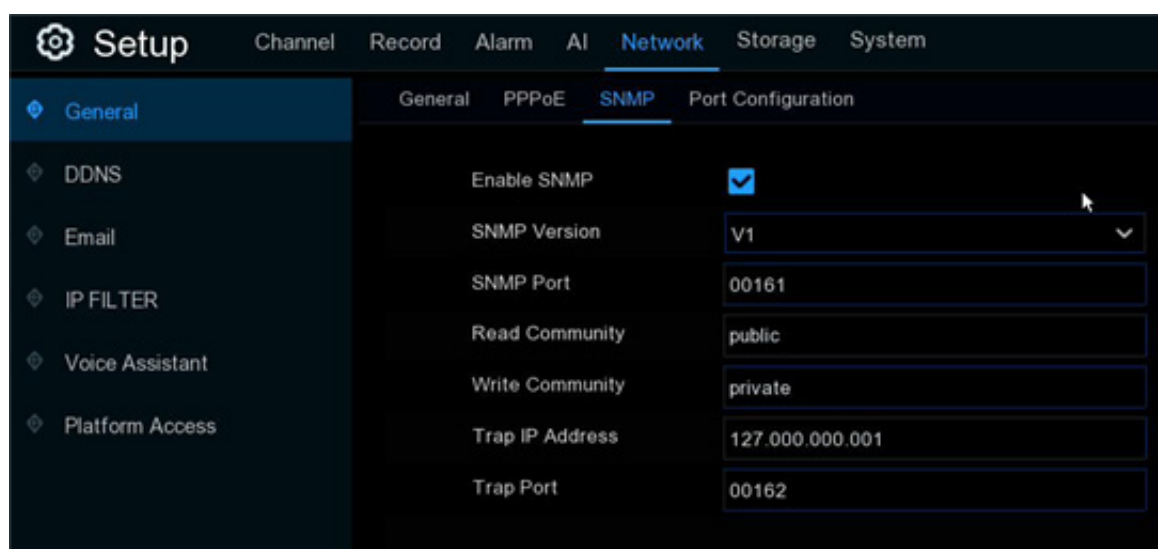

NOTE: The Wi-Fi connection function is not a universal feature for all models. Inquiry your local dealer before using this feature.

Before proceeding, disconnect the Ethernet cable from your NVR's Ethernet port (if connected).

1. Tick the checkbox of **Enable** to activate the Wi-Fi connection.
2. Click the **Scan** button. After a short moment, a list of Wi-Fi access points that your NVR detects will be shown. If the access point you want to connect is not shown in the list, click **Update** button to refresh.

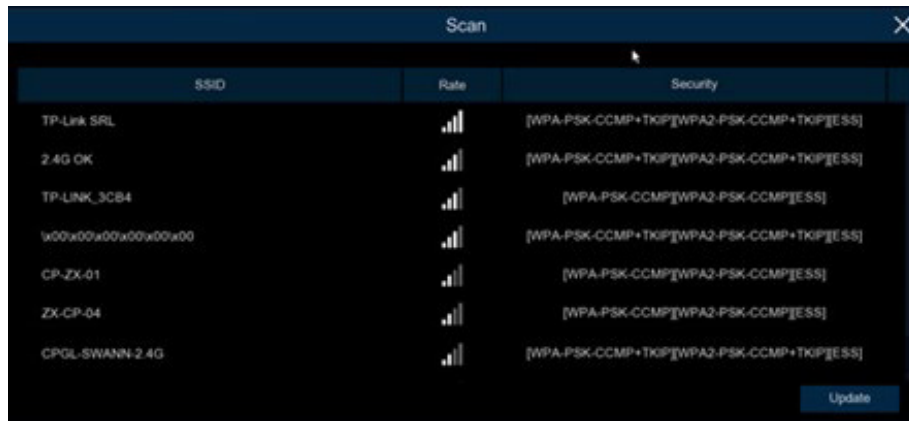

3. Double click on the access point you want to connect.
4. Input the password for your Wi-Fi access point, then click the **Join** button. Ensure the password is correct before proceeding.
5. After a short moment, your NVR will connect to your Wi-Fi access point. Click **OK** to continue. If the connection has failed, check that the password is correct. The Link Status will change to Connected, showing a successful connection. Click **Apply** to save settings.

5.5.1.4 - Port Configuration

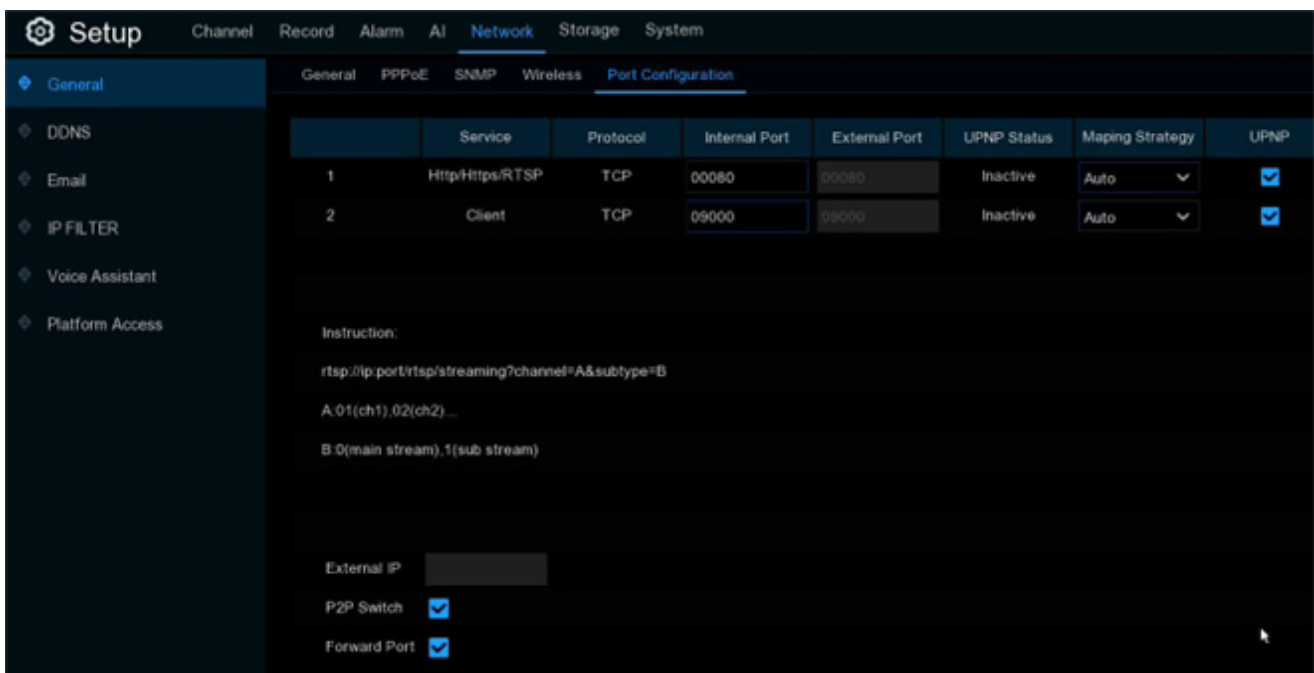

http/https/rtsp: This port is mostly used to log into your NVR via webpage or 3rd party streaming player by rtsp protocol. If the default port number (80) is used by other devices in the network, you may need to change it.

Client Port: This is the internal port that your NVR will use to send information through. This particular port number (9000) is not used by many devices, however, if you have another NVR-like device, you may need to change it.

EN

Internal Port: It is mostly used to access the NVR from the same LAN.

External Port: It is mostly used to access the NVR from a different LAN or internet. You need to forward the external ports to internet from your router manually. If you want to access your NVR via internet, which would be a little more complicated for users without network knowledge. Using **UPNP** would make it easier.

UPNP is a network protocol designed to allow network-connected devices to automatically obtain and forward the ports from the router.

1. Tick the checkbox of **UPNP**.
2. Choose **Auto** on Mapping Strategy, the external port will be automatically obtained and forwarded from your router.
3. If you want to change the external port by manual, choose **Manual** on Mapping Strategy and then modify the port accordingly.

	Service	Protocol	Internal Port	External Port	UPNP Status	Mapping Strategy	UPNP
1	Http/Https/RTSP	TCP	00080	3191	Activate	Auto	<input checked="" type="checkbox"/>
2	Client	TCP	09000	57626	Activate	Auto	<input checked="" type="checkbox"/>

P2P Switch: Click to enable P2P function.

IP Camera Hyperlink: This advanced feature allows to visit the webpage of the IP cameras which are connected to the NVR when you're accessing in the NVR's webpage. Tick the checkbox to enable this feature and click **Apply** to save, you will find the hyperlink of each capable IP camera on the NVR's webpage.

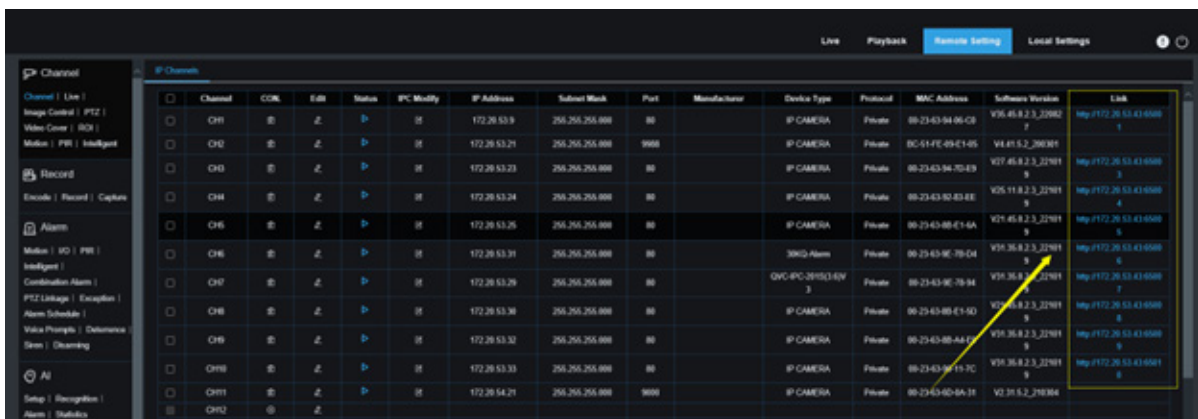

5.5.2 - DDNS

This menu allows you to configure DDNS settings. The DDNS provides a static address to simplify remote connection to your NVR. To use the DDNS, you need to create an account on the web page of DDNS service provider firstly.

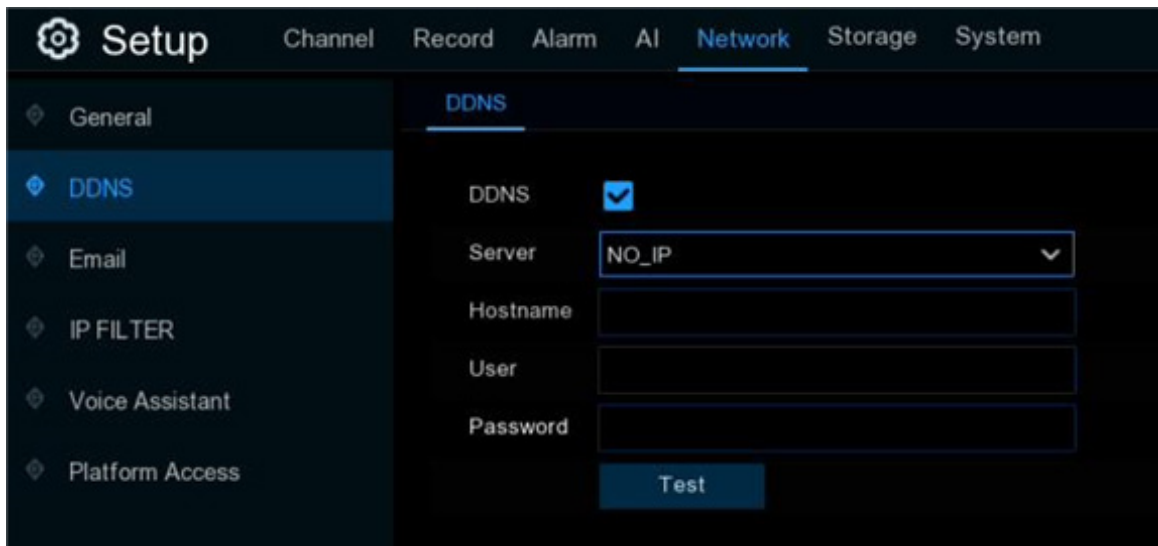

DDNS: Check to enable DDNS.

Server: Select the preferred DDNS server (DDNS_3322, DYNDNS, NO_IP, CHANGEIP, DNSEXIT).

Domain: Enter the domain name you created on the web page of DDNS service provider. This will be the address you type in the URL box when you want to connect remotely to the NVR via PC. For example: "nvr.no-ip.org".

User/Password: Enter the user's name and password you obtained when creating an account on the web page of DDNS service provider.

After all parameters are entered, click **Test DDNS** to test the DDNS settings. If the test result is "Network is unreachable or DNS is incorrect", please check whether the network works fine, or the DDNS information is correct or not.

5.5.3 - Email Settings

This menu allows you to configure the email settings. Please complete these settings if you want to receive the system notifications on your email when an alarm is triggered, HDD becomes full, HDD is in error state, or Video Loss occurs. Email is also important when you need to reset your password.

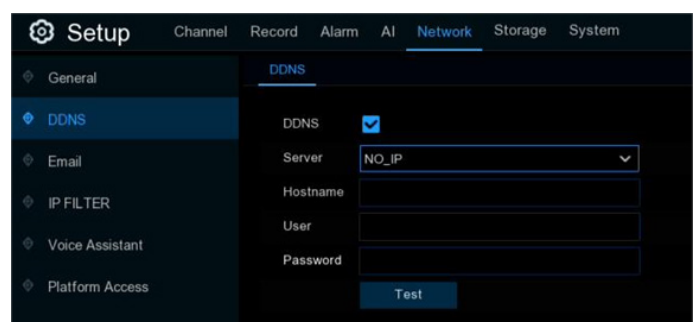

5.5.3.1 - Email Configuration

Email: Click the checkbox to enable.

Encryption: Enable if your email server requires the SSL or TLS verification. If you are not sure, set to be Auto.

SMTP Port: Enter the SMTP port of your email server.

SMTP Server: Enter the SMTP server address of your email.

User Name: Enter your email address.

Password: Enter the password of your email.

Receiver 1~3: Input the email address(es) to send email alerts to.

Interval: This is the length of time that must elapse after your NVR sends an email alert before it will send another. Adjust accordingly.

To make sure all settings are correct, click **Test Email**. The system sends an automated email message to your inbox. If you received the test email, it means the configuration parameters are correct.

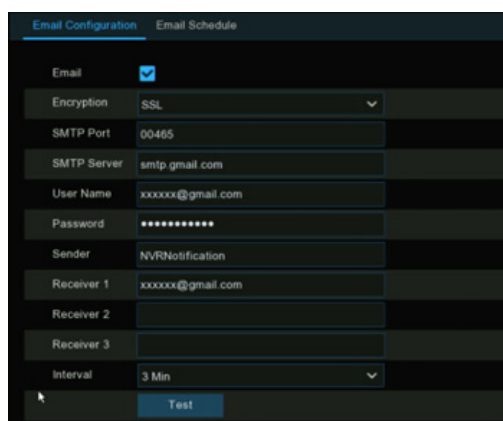

EN

5.5.3.2 - Email Schedule

If email alerts are enabled on your NVR, alerts would be emailed 24 hours as default. You can change the schedule when your NVR can send those alerts. For example, you may only want to receive alerts during the day but not in the evening. An alternative schedule can be created for each camera.

1. Select a channel you want to set the schedule.
2. Click on ratio button of the alarm type that you want to send email alerts for:
 - **Motion:** Email alerts for motion detection events
 - **IO:** Email alerts for I/O triggered events
 - **Exception:** Email alerts for exception events which include no space left on the hard drive, a hard drive error or if one of the channels has lost the feed from its camera.
 - **Intelligent & AI:** Email alerts for Intelligent or AI detection events
 - **PIR:** Email alerts for PIR events
3. Using the mouse, click on a square to change or click and drag the mouse over the squares corresponding to your desired period
4. Repeat step 2 & 3 to set the schedule for other alarm type.
5. The set schedule is valid only for one channel. If you want to use the same recording schedule for other channels, use **Copy** function.
6. Click **Apply** to save your settings.

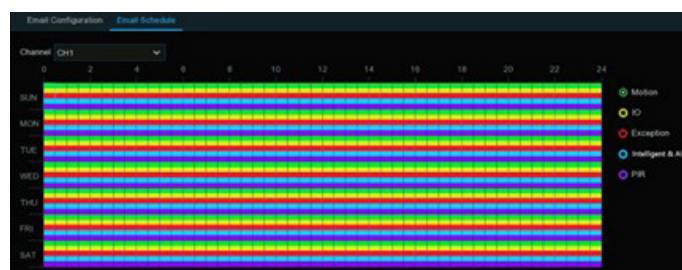

5.5.4 - IP Filter

IP Filtering is a great way to limit access to your network devices for specific groups of IP addresses. For example, if you had a malicious user attacking your network, you could add a filter to prevent access to your devices from a single IP address or a block of IP addresses.

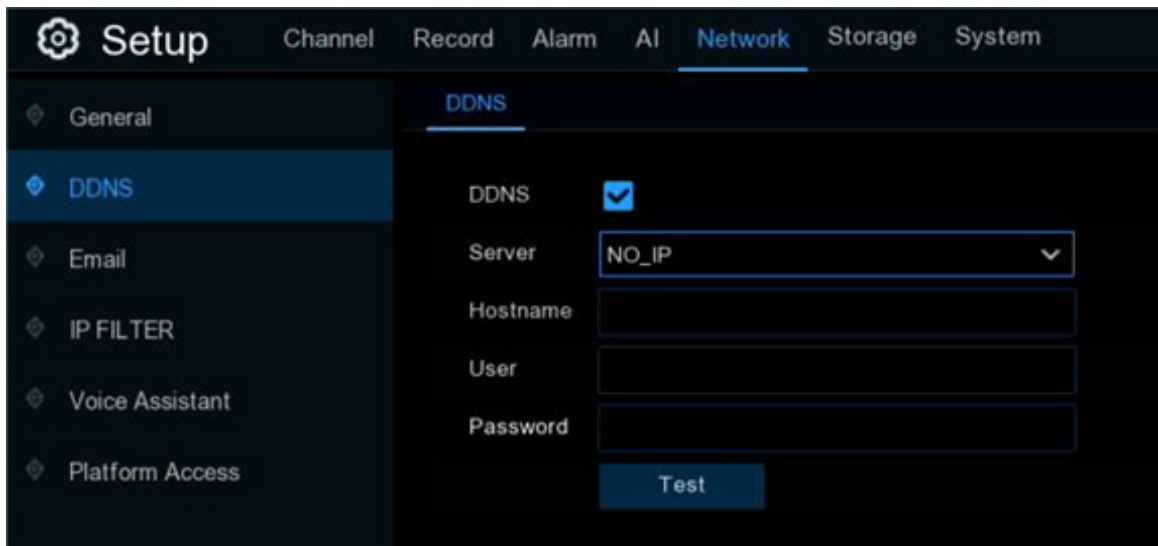

Allow List: It includes a range of IP addresses you define that indicates what IP addresses are allowed to access your NVR to prevent unauthorized IP addresses from logging into your NVR.

1. Tick the checkbox of Enable to activate the IP filter function.
2. Click on the ratio button of **Enable Allow List**.
3. Choose **Allow List** from **Restricted Type**.
4. If you want to add individual IP address into the allow list, click **Single IP Address** to input the IP address. If you want to add a block of IP addresses, click **IP Address Range** to input the start IP address and end IP address.
5. Click **Save**. Only IP address(es) from the Allow List can access your NVR now.

Block List: It includes a range of IP addresses you define that indicates what IP addresses are forbidden to access your NVR to prevent unauthorized IP addresses from logging into your NVR.

1. Tick the checkbox of Enable to activate the IP filter function.
2. Click on the ratio button of **Enable Block List**.
3. Choose **Block List** from **Restricted Type**.
4. If you want to add individual IP address into the allow list, click **Single IP Address** to input the IP address. If you want to add a block of IP addresses, click **IP Address Range** to input the start IP address and end IP address.
5. Click **Save**. IP address(es) from the Block List is forbidden to access your NVR now.

5.5.5 - Voice Assistant

The voice assistant function allows to connect your NVR to your GoogleCast or Amazon Fire TV Stick, and cast the real-time surveillance images on your TV monitor by voice control.

EN

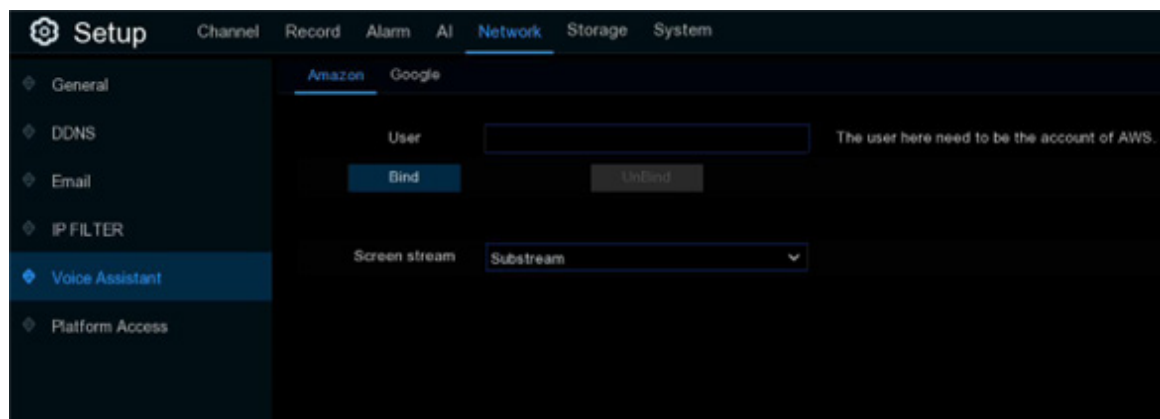

5.5.5.1 - Voice Assistant with Amazon Fire TV Stick

1. Input your Amazon account, and the click **Bind** button to bind your Amazon account. Then choose the video stream you want to cast on your TV monitor.

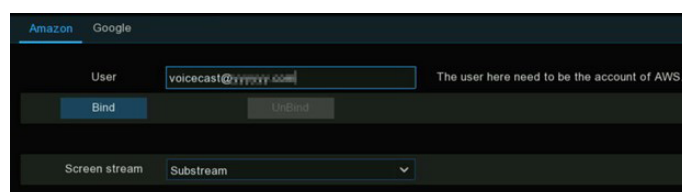

2. Go to Channel → Live menu, and give a Channel Name which is easy to call to the channel(s) you want to cast on your TV monitor.

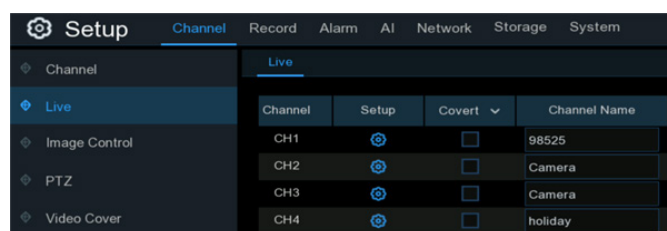

3. Connect the Fire TV Stick to your TV monitor, and power on it. Connect the Fire TV Stick to the Wi-Fi which is in the same LAN with your NVR.

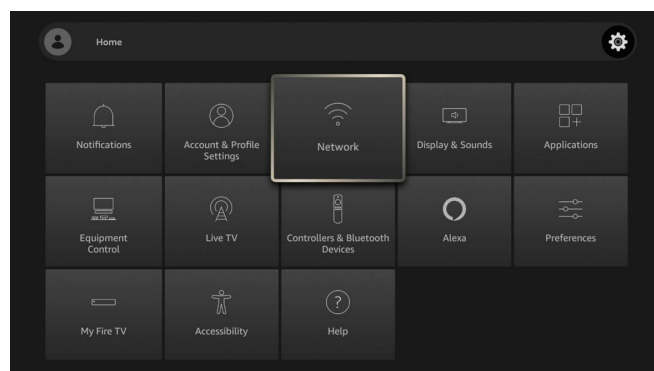

- To use your existing profile or add a new profile and login your Amazon account which is same as the one you bind to the NVR.

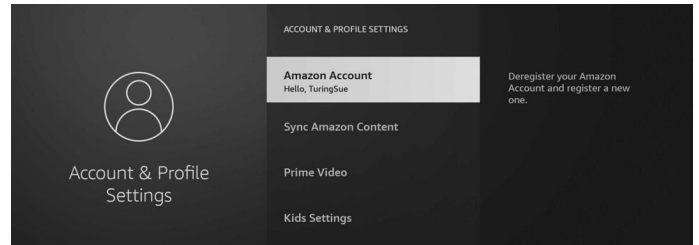
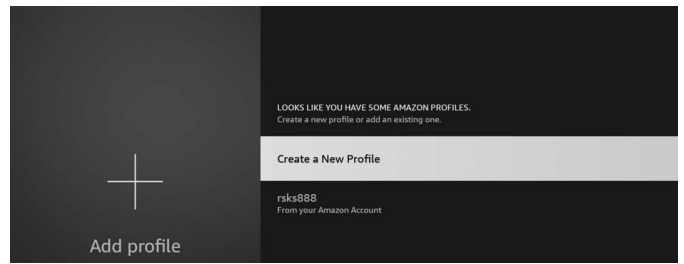

- Search and install Amazon Alexa to your mobile phone from app store, and then login with the Amazon account which is same as the one you bind to the NVR.

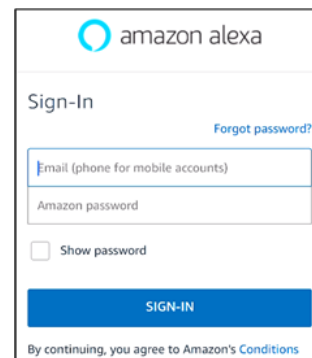

- Touch **More**, and then touch **Skills & Games**.

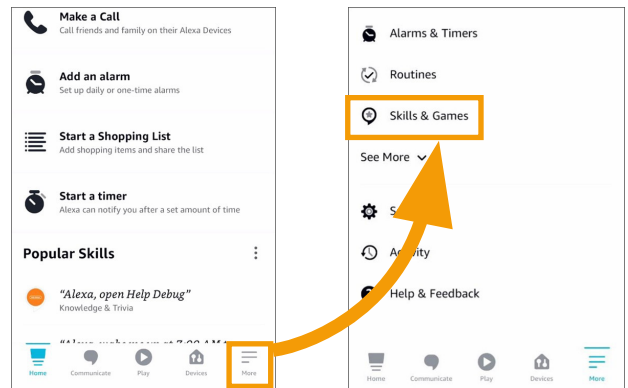

- Touch the search icon on the top right corner.

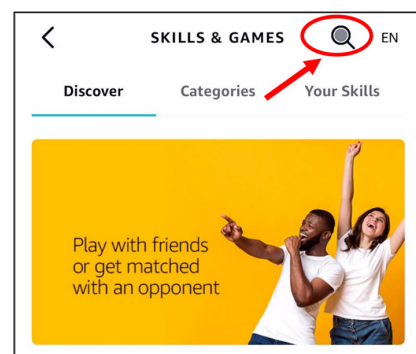

8. Input the keyword: smart camera view, and search.

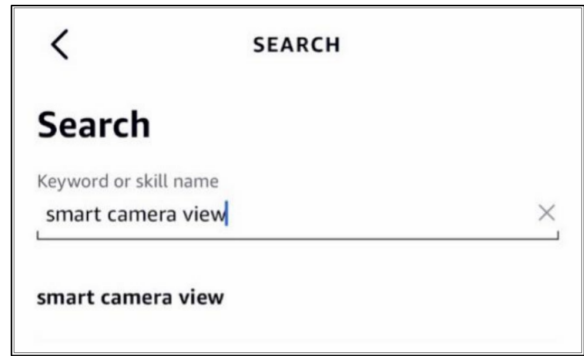

9. Touch the **Smart Camera View** app in the search result list. And then Touch **ENABLE TO USE**.

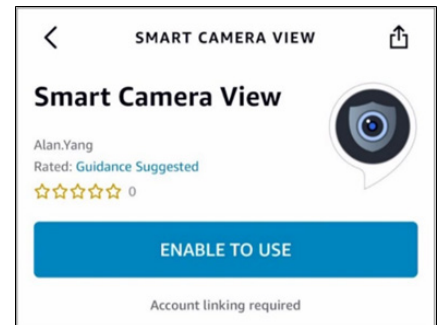
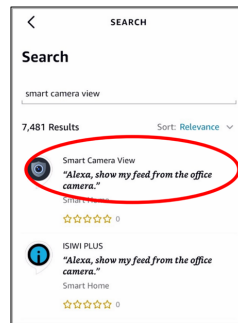

10. You would need to link your Amazon account. Sign in the Amazon account which is same as the one you bind to the NVR. Touch **Done** after the skill is successfully linked.

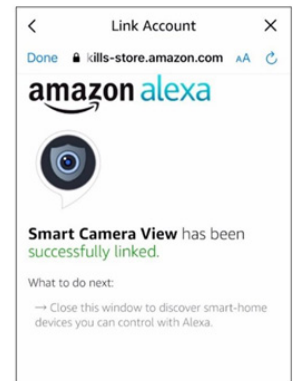
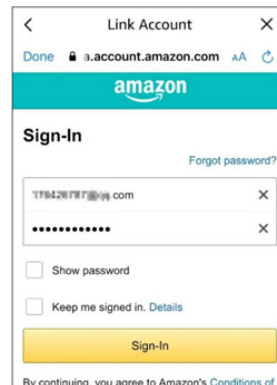

11. Touch **DISCOVER DEVICES** and wait a moment for the app to search the cameras. Touch **Next** when the devices were found and connected.



12. Choose one of the devices and then touch **SET UP DEVICE**. You can add the camera to a group or skip.

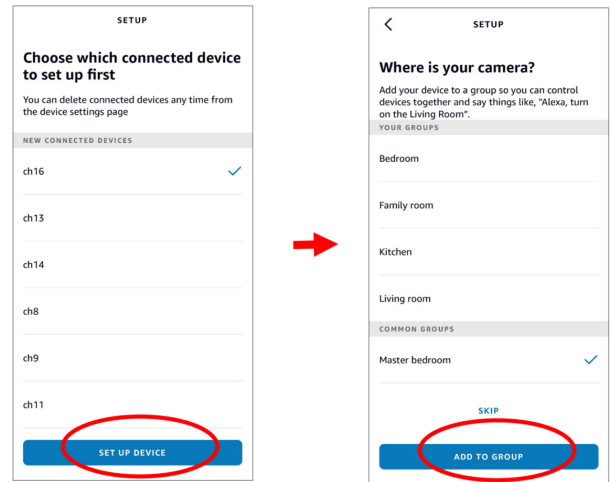

13. Repeat setup 12 to add all cameras and then touch **Done** to finish.

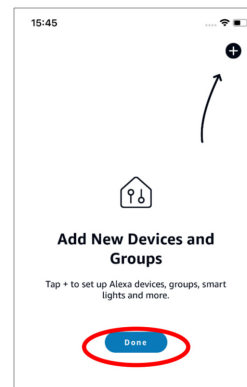

14. All added cameras will be listed in the Devices. Touch the **Cameras** icon to check all added cameras.

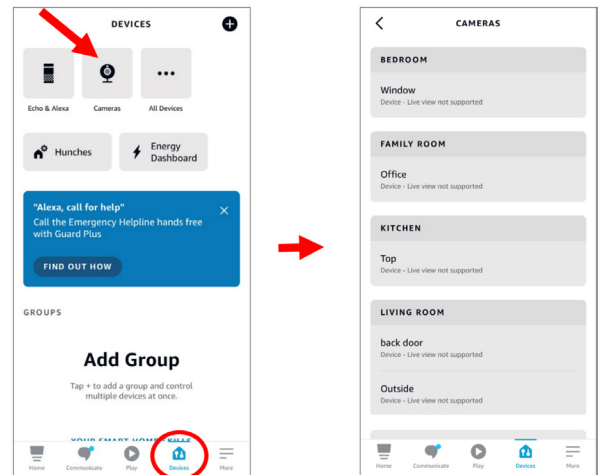

15. Press and hold on the voice button on the remote controller of the fire TV stick, and speak the command clearly. The command could be like: Show the XXX camera / Show XXX. XXX is the camera channel name. For example, if the channel name is **Office**, you could speak **Show my office camera**.

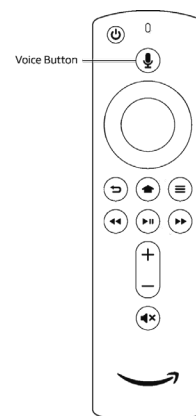

16. Wait for a while, you will see the real time images from the Office camera on your TV monitor.
17. If you want to quit the camera live view, speak **Stop**.
18. If you have changed the channel name, you would need to discover and add the camera again.

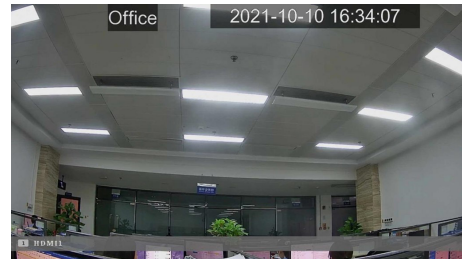
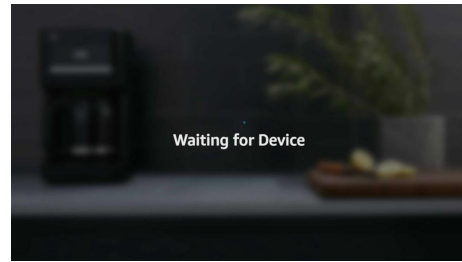

5.5.5.2 - Voice Assistant with Google Chromecast

1. Input your Google account, and then click **Bind** to connect to bind your Google account. To choose the video stream you want to cast on your TV monitor.

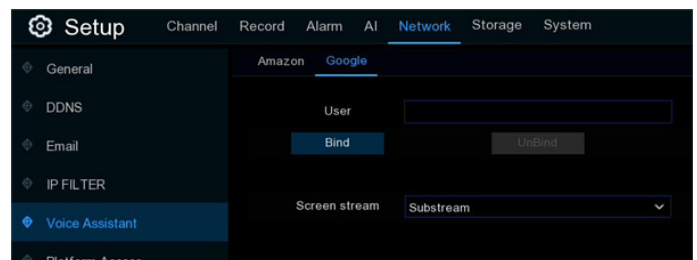

2. Go to Channel – Live menu, and give a Channel Name which is easy to call to the channel(s) you want to cast on your TV monitor.

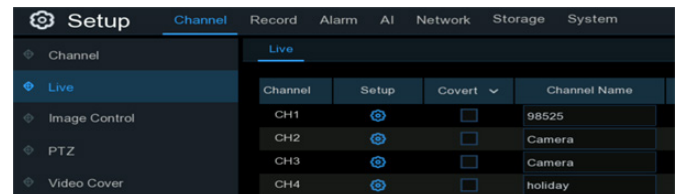

3. Connect the Chromecast to your TV monitor, and power on it.

4. Search and install Google Home app to your mobile phone from app store. Run the installed Google Home app, touch **OK** to allow the app to use your local network and Bluetooth and then touch **Get Started**.

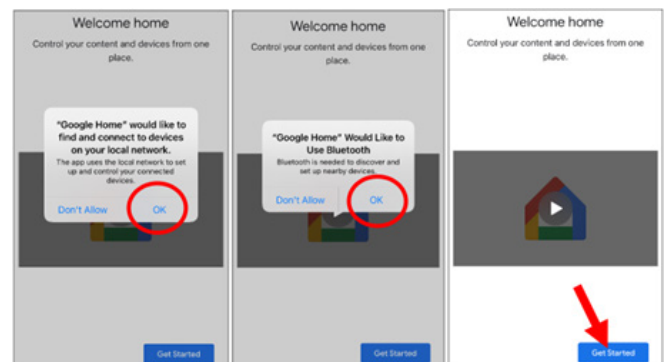

5. To login your Google account which is same as the one you bind to the NVR.
6. Touch **Get Started** to create a home, and then touch **New devices**.

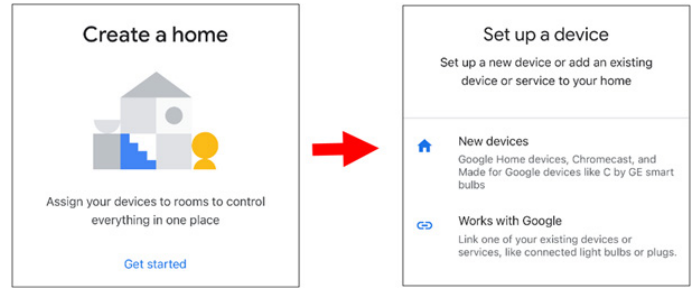

Input the Home nickname and address and then touch **Next**.

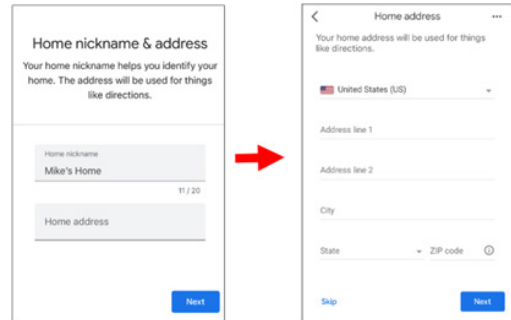

To allow location access for the app.

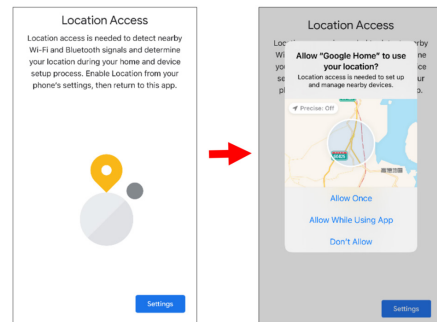

7. The app will automatically try to search devices from your local network. Choose Chromecast / Google TV. Make sure your Chromecast is turned on already, then touch **Next**.

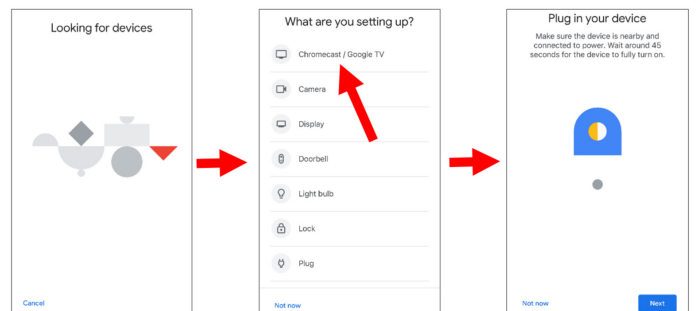

8. Your Chromecast will be found. Touch **Next** to connect. Confirm the code by touching **Yes**.



9. Choose a location for your Chromecast, then touch **Next**.

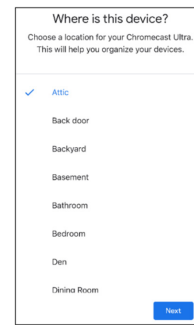

10. Choose the Wi-Fi network for your Chromecast and input the Wi-Fi password to connect. Make sure the Wi-Fi you choose is the same one with your mobile phone and is in the same local network with your NVR. Touch **Continue** to next step.

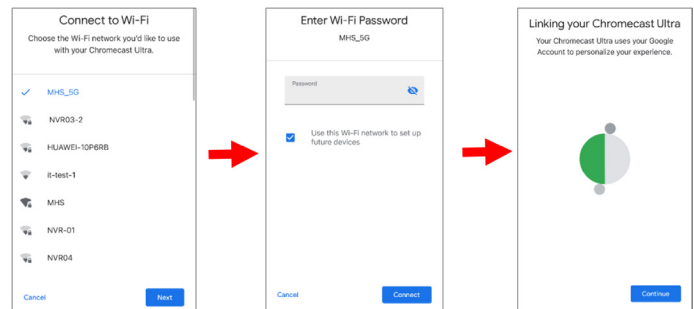

11. Touch **No Thanks**, or **Sign Up** to login your google account.

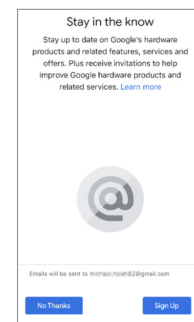

Touch **Next** and **Skip Tutorial**, and then touch **Finish Tutorial**.

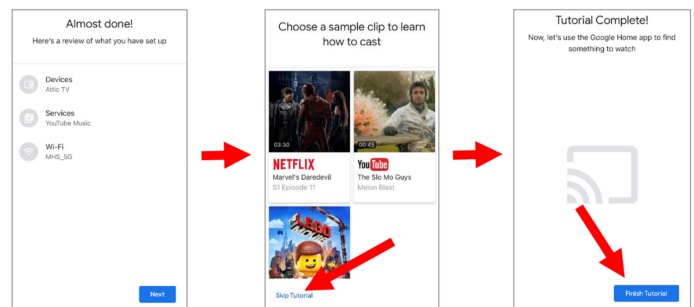

12. Now the Chromecast has been added to your Google Home. Touch the + icon on the left top corner. Indoor, then choose **Set up device**.

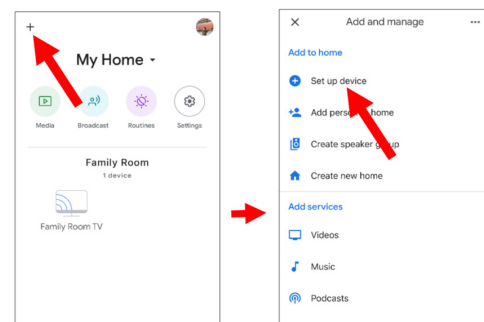

Choose **Work with Google**, touch the search icon on the right top corner and then input **smart camera view**.

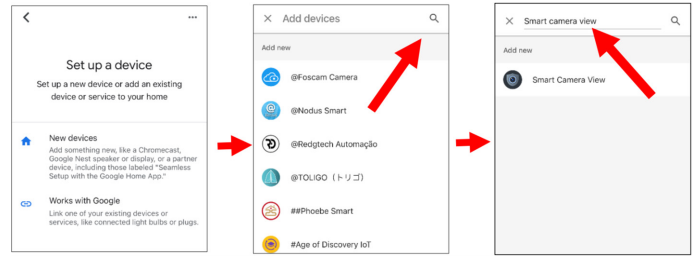

Touch on **Smart Camera View** in the search result. You would need to sign in your google account and allow the Google to access to your device.

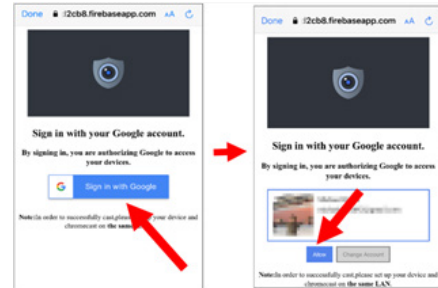

Wait for a while, the Smart Camera View application will be linked to the Google Home.

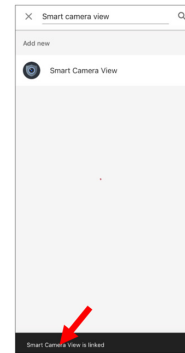

- Now the available cameras in your NVR will be displayed. Choose one of the cameras and then touch **Next** button. Choose a home & location for the cameras step by step. Repeat this step to add all cameras.

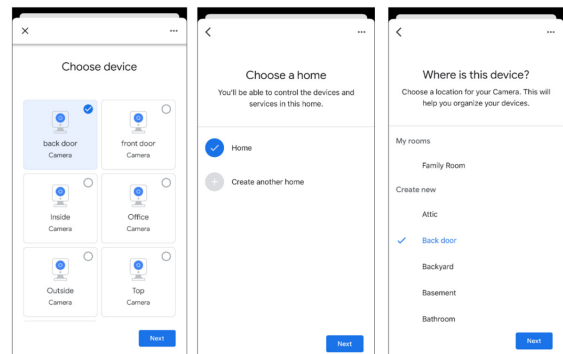

- Search and install Google Assistant app to your mobile phone from app store.
- Run the Google Assistant, login your google account which is same as the one you bind to the NVR.

- Now, you're able to stream your camera to your TV monitor by using text or voice command, like "Show/play the *** Camera on XXX TV", in which *** is the channel name of the camera, XXX is your TV's name.

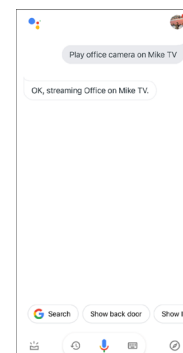

5.5.6 - Platform Access

5.5.6.1 - ONVIF

EN

This function is mainly used to connect 3rd party platform, like ECMS/NVMS via Onvif protocol.

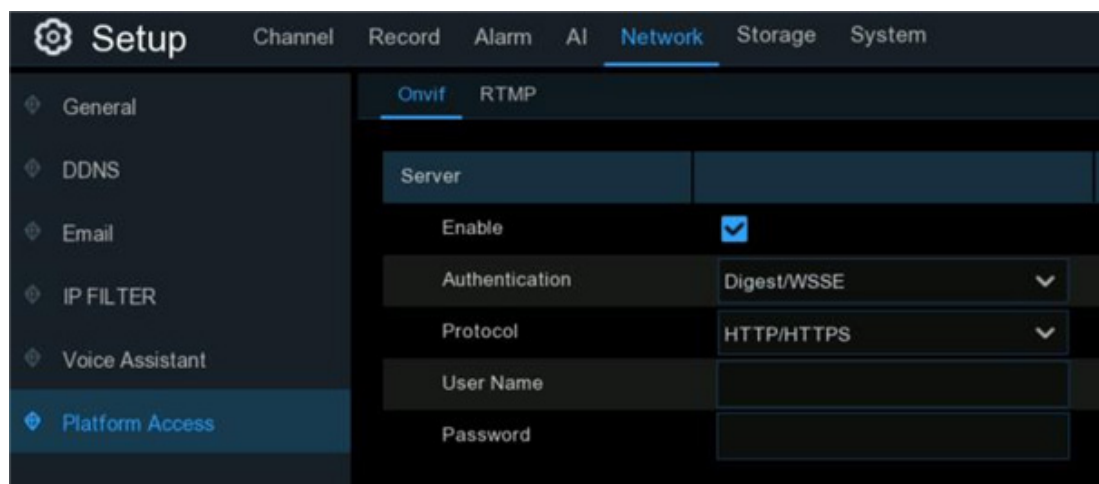

Enable: Check to enable this function.

Authentication: Login authentication type, options including Digest_sha256, Digest, Digest/WSSE, WSSE and None. Choose one of them to match to your 3rd party platform.

Protocol: Choose http, https or both of them.

User Name: To set a user name for platform connection.

Password: To set a password for platform connection.

NOTE: Only images of Channel 1 will be displayed on the 3rd party platform.

5.5.6.2 - RTMP

The audio and video streams of the NVR channels can be pushed to the YouTube website by RTMP for live broadcasting. To use this function, you need to do the following: Register a YouTube account, create a live streaming studio, set the URL and live code of the live streaming studio, set the live server address bar for the device, and enable and configure the code stream type and live broadcasting channels. After saving the configuration, you can go to the YouTube live room to refresh the page to watch live broadcasting.

Enable: Used to set whether to enable the RTMP live broadcasting function.

Server Address: Enter the live broadcasting address and live code of the YouTube server. (Note: "/" is used between the live broadcasting address and live code of the YouTube server.)

Stream Type: Select the stream type of the live broadcasting channel. Both the main stream and substreams are supported.

Channel: Select the channel for live broadcasting. Only one channel can be selected.

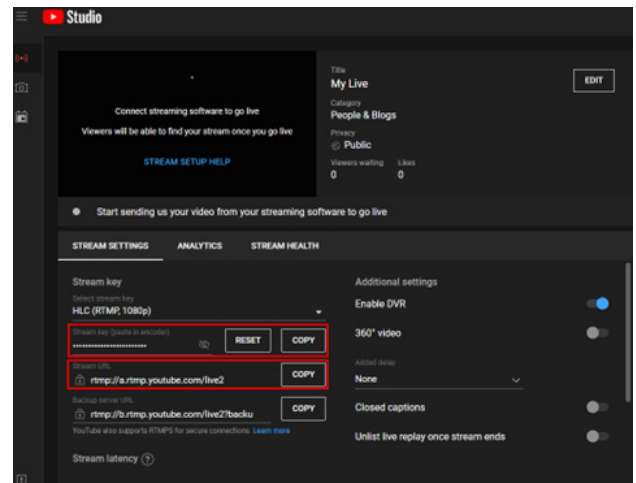

NOTE: To ensure the live broadcasting effect, it is recommended that the resolution of the stream not exceed 1920 × 1080. Live broadcasting can be conducted for only the data streams of H.264 video encoding format and G711A/U audio encoding format. A YouTube live code can be set for only one device and cannot be reused.



5.6 - Device

In this section, you can configure the storage devices, including the internal HDD storage and external NAS storage & cloud storage.

EN

5.6.1 - HDD

This function gives you the option of formatting your NVR's hard drive, and it will be listed here for selection (if a new hard drive has been installed inside your NVR, you need to format the drive before it can be used).

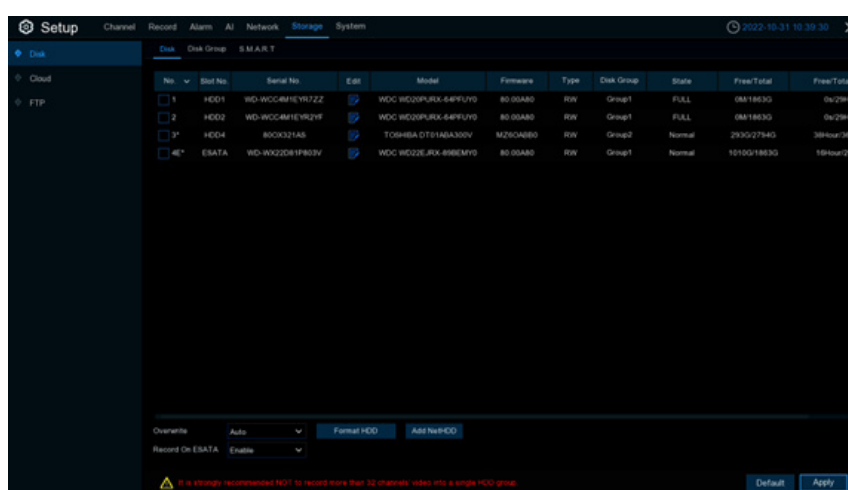

Format HDD: Click the checkbox to select the hard drive then click this button to format. You have three options to select from:

- Format the entire hard disk. All data will be erased: As stated, all data including events, log files and analytic information will be erased.
- Only format the record partition. All record data will be erased: Only data such as videos, snapshots and log files will be erased. All analytic information will be kept.
- Only format the general partition. All AI related data may be erased: Only analytic information will be erased. Videos, snapshots and log files will be kept on the hard drive.

Select the relevant option, then click **OK**. Input your password, then click **Authenticate**. A message will appear noting the data that will be erased. Click **OK** to continue.

Overwrite: This instructs your NVR to overwrite the oldest video files as the hard drive becomes full. You also have the option of selecting the amount of days for recordings to be kept before they are overwritten. For example, if you choose the option 7 days then only the last 7 days' recordings are kept on the HDD. To prevent overwriting any old recordings, select **OFF**. If you have set Off on this feature, please check the HDD status regularly to make sure the HDD is not full. Recording will be stopped if HDD is full. We recommended leaving the **Auto** selection as this prevents your NVR from running out of storage space.

Record on ESATA: This menu only displayed when your NVR is coming with an e-SATA port on the rear panel and your e-SATA HDD has been connected to the NVR already. It will allow to record the video to external e-SATA HDD to enhance your HDD capacity. If the e-SATA recording function is enabled, e-SATA backup function will be disabled.

Add NAS HDD: To add your NAS disk.

Mounting Type: To choose the mounting type from NFS and SMB/CIFS. You would need to input the account name and password of NAS if you choose SMB/CIFS.

Server IP: IP the IP address of NAS storage.

Directory Name: Input the directory name on which you want to save your recording data.

Disk Size: To set the capacity size of the NAS storage.

Test: Click to test the connection of NAS storage.

Add NAS HDD: Click to add NAS storage.

If your NVR supports to install multiple hard disks and more than 1 hard disk is installed in your NVR, the edit button  will be appear in your system, you can click it to edit the HDD as below:

Disk Type: You can set the hard disk to be Read Write, Read Only, or Redundant.

Read Write mode is the normal status for an HDD to save recordings or search recordings to play. If all the installed hard disks are set to Read Write mode, the NVR will save recordings to the hard disks sequentially.

To prevent important video data from being overwritten during cyclic recording, the hard drive disk can be set as **Read Only** mode. New recordings will be not able to save into this read only disk. You can still search recording from this read only disk to play.

Redundant hard disk can be used to save the recordings same as what is saved to Read Write hard disk(s). When a redundant disk is set, the system can save recording in parallel to both the Read Write hard disk and the redundant hard disk in case of hard disk failure.

- NOTE:**
1. Redundant disk supports to save mainstream recording only.
 2. If the disk type has been changed, the hard disks might be unmounted and offline. Please wait a while till the hard disks get mounted again.

Disk Group: You can set the disks into different disk group for recording. See more on 5.6.1.1 Disk Group.

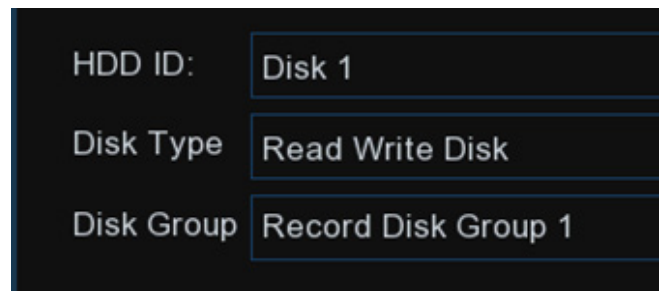
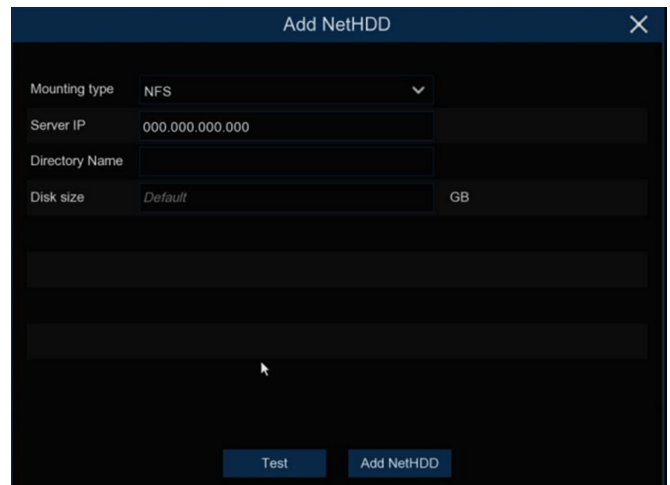

5.6.1.1 - Disk Group

If your NVR supports to install multiple hard disks and more than 1 hard disk is installed in your NVR, you will see this menu. With Disk Group function, you can assign different cameras to be recorded into different groups in order to reduce the loading on a single hard disk and extend the life of hard disk.

1. On the Disk list page, click on the edit button of the hard disk you want to configure, and then select its Disk Type and Disk Group.
2. Go back to Disk Group page, choose a Disk Group Type. If all the hard disks are set as Read Write mode, only Record Disk Group available to choose here. If one or more hard disks are set as Redundant mode, Redundant Disk Group will be available to choose here.
3. Choose the Disk Group.
4. Select the Record Channel. It indicates which camera(s) will be recorded and saved into the hard disk(s) in the selected group. Maximum 16 cameras can be recorded in a group.
5. Click **Apply** to save your settings.

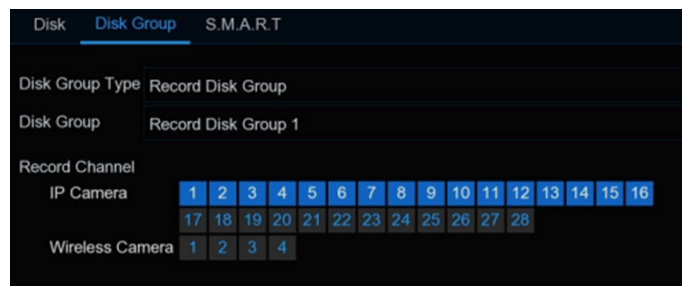

5.6.1.2 - S.M.A.R.T

This function is used to display technical information on the hard drive installed inside your NVR. You can also perform a test (there are three types available) to evaluate and detect potential drive errors.

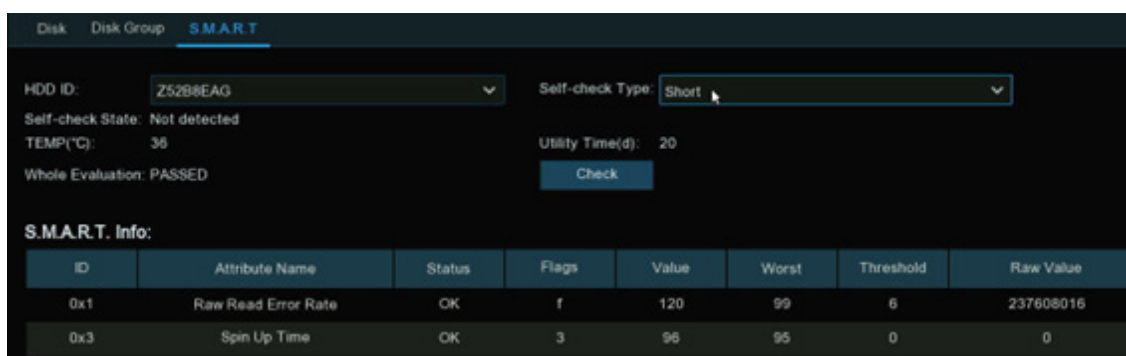

Self-check Type: There are three types available:

- **Short:** This test verifies major components of the hard drive such as read/ write heads, electronics and internal memory.
- **Long:** This is a longer test that verifies the above as well as performing a surface scan to reveal problematic areas (if any) and forces bad sector relocation.
- **Conveyance:** This is a very quick test that verifies the mechanical parts of the hard drive are working.

When performing a test, your NVR will continue to work as normal. If an HDD S.M.A.R.T error found, the HDD can be continued to use, but there will be a risk to lose recording data. It is recommended to replace a new HDD.

5.6.2 - Cloud Storage

Your NVR can copy snapshots and video recordings to the cloud via Dropbox™ or Google Drive™ which is a service that allows you to store and share snapshots and video recordings and always have them on hand when needed.

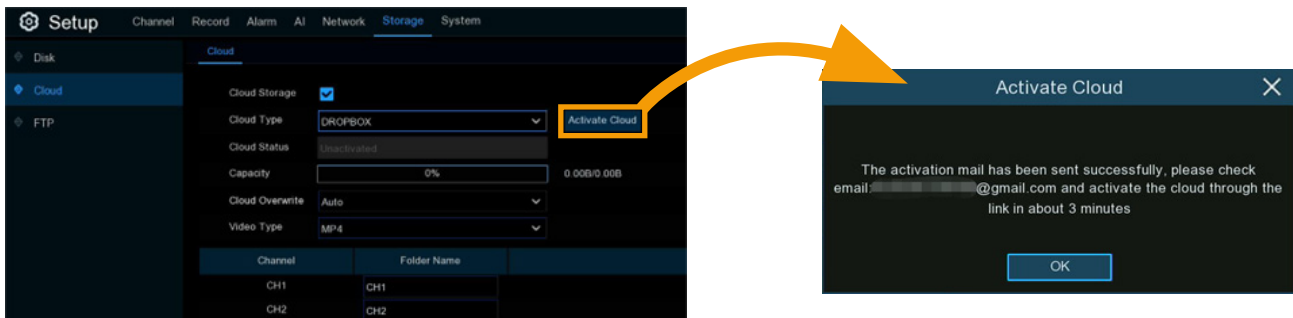

Cloud Type: To choose Dropbox or Google Drive.

Cloud Status: This will change to Activated when active.

Capacity: When activated, this will display how much free space you have on your cloud storage.

Cloud Overwrite: This instructs your NVR to overwrite the oldest video files as the cloud storage becomes full. You also have the option of selecting the amount of days for recordings to be kept before they are overwritten. For example, if you choose the option 7 days then only the last 7 days' recordings are kept on the cloud storage. To prevent overwriting any old recordings, select OFF. If you have set Off on this feature, please check the storage status regularly to make sure the space is not full. Pictures or recordings will be stopped to upload if the space is full. We recommended leaving the Auto selection as this prevents the cloud storage from running out of storage space.

Video Type: To choose the video format you want to upload.

Folder Name: To create a folder for each camera for saving its uploading files.

5.6.2.1 - Dropbox Settings

1. Before activation, we recommend that you create a Dropbox account first. Go to www.dropbox.com, input your name, email address, and password, agree to the terms & conditions, then click or tap the sign up button. If you already have a Dropbox account, you can skip this step.
2. Click the **Activate Cloud button**, the system will send an activation letter to your receiver email box which you have set in the Email Setup page.
3. Login your email box and click the link in the email content. It will turn to the cloud server authorization login page. Input your Dropbox account name and password to login.

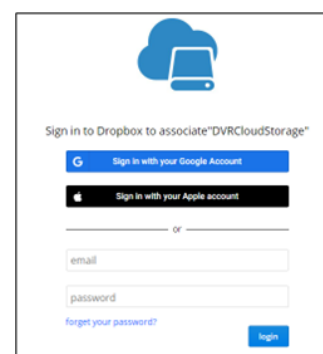

4. Input the DVR local IP address and web port, and then click Authorize.

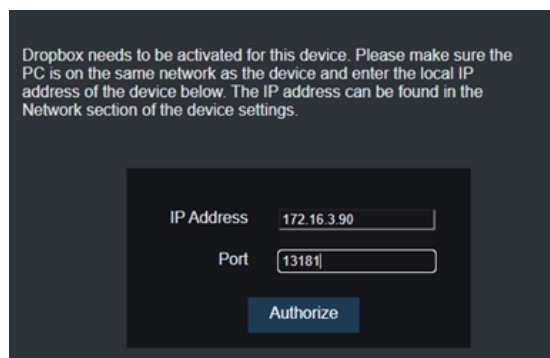

EN

5. Input the DVR user name and password and then click OK.

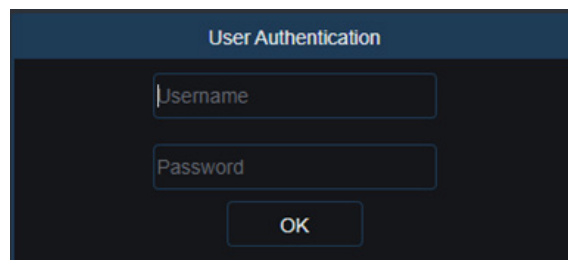

6. Authorization finished; the webpage will turn to your Dropbox.

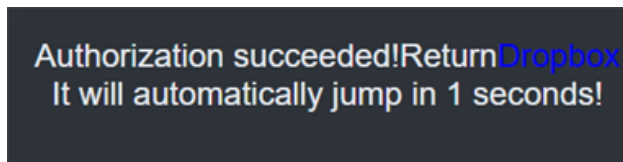

7. The Cloud has completed the setup if you find a new folder named by your NVR device name and MAC address in the Dropbox storage. Your alarm pictures and videos will be upload to this folder.

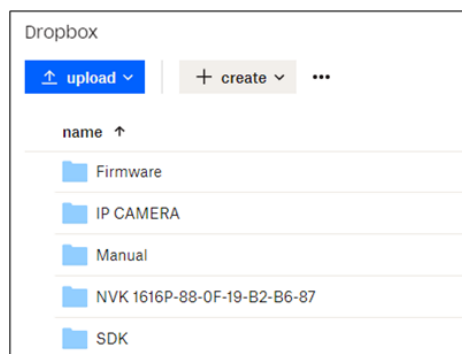

5.6.2.2 - Google Drive Settings

1. Before activation, we recommend that you create a Google Drive account first. Go to <https://www.google.com/drive>, input your name, email address, and password, agree to the terms & conditions, then click or tap the sign up button. If you already have a Google Drive account, you can skip this step.

2. Click the Activate Cloud button, the system will send an activation letter to your receiver email box which you have set in the Email Setup page.

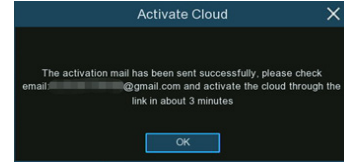

3. On the email, you will find an activation code and a link illustrated as below. Click the link and then enter the activation code you received on the webpage, and then click **Next**.

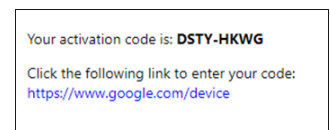
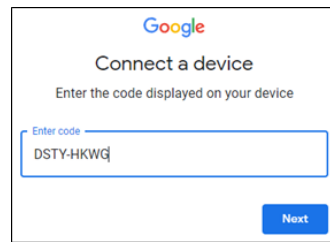

4. Enter your Google account and password to login your Google Drive.

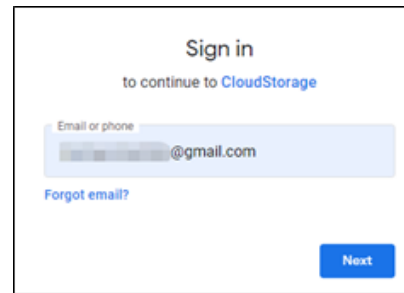

5. Click **Allow**, the settings of your Google Drive cloud have completed now.

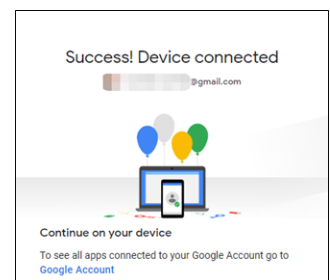
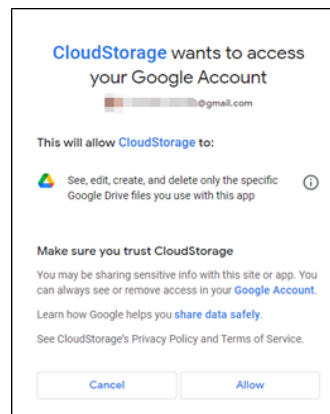

5.6.3 - FTP Settings

This menu allows to configure your FTP settings for uploading captured snapshots or videos to your FTP server.

EN

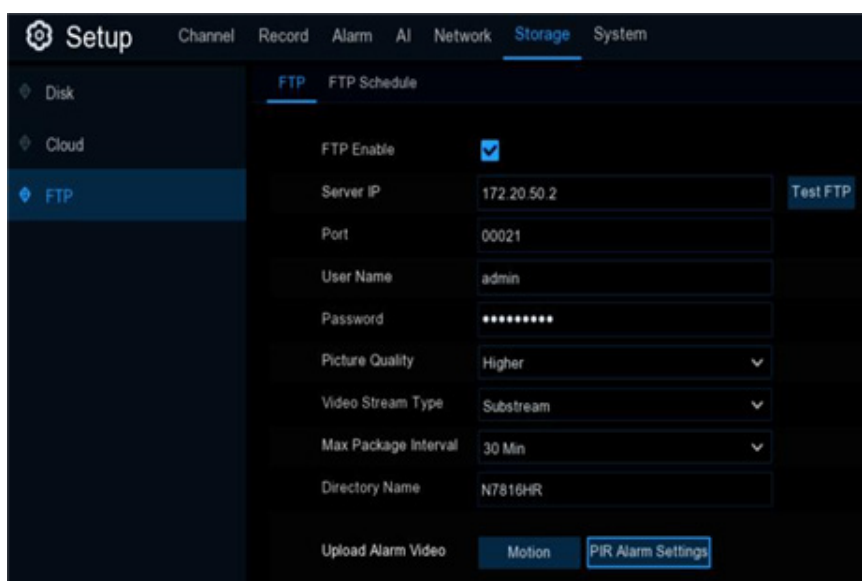

FTP Enable: Tick the checkbox to enable FTP function.

Server IP: Enter IP address or domain name of your FTP server.

Port: Enter the FTP port for file exchanges.

User Name/ Password: Enter the user name and password of FTP server.

Picture Resolution: To choose the resolution of snapshots that you want to upload. Maximum resolution is 1920x1080.

Picture Quality: Choose the image quality of snapshots that you want to upload.

Video Stream Type: Choose mainstream or substream video you want to upload.

Max. Package Interval: Set the maximum time duration of each single video you want to upload.

Directory Name: Enter the directory name on your FTP server to save the uploaded pictures and videos.

To make sure all settings are correct, click **Test FTP**. The system sends an automated file to your ftp server. If you received a message shown "Write to file succeeded!", it means the configuration parameters are correct.

5.6.3.1 - FTP Schedule

If FTP upload is enabled on your NVR, alarm images or videos would be uploaded 24 hours as default. You can change the schedule when your NVR to upload the alarm images or videos. For example, you may only want to receive alarm images or videos during the day but not in the evening. An alternative schedule can be created for each camera.

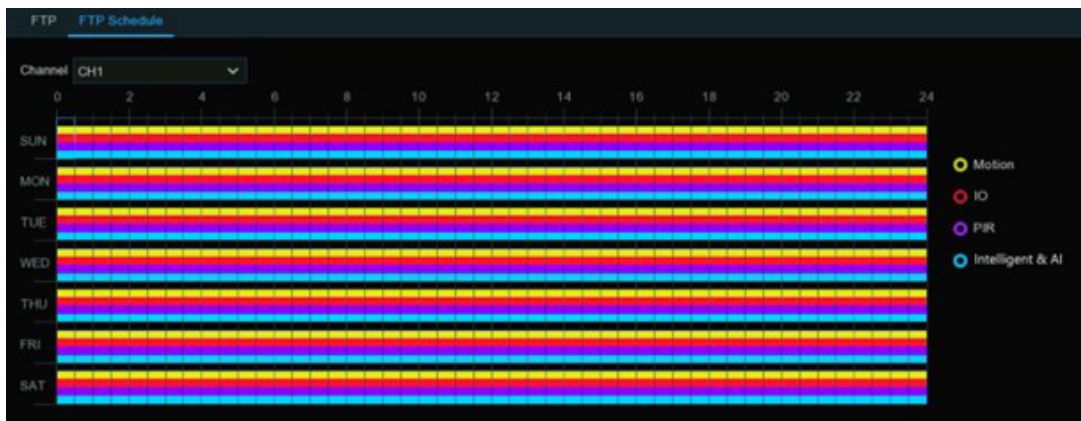

1. Select a channel you want to set the schedule.
2. Click on ratio button of the alarm type that you want to upload for:
 - **Motion:** Upload for motion detection alarm images or videos
 - **IO:** Upload for I/O triggered alarm images or videos
 - **PIR:** Upload for PIR detection alarm images or videos
 - **Intelligent & AI:** Upload for Intelligent or AI detection alarm images or videos
3. Using the mouse, click on a square to change or click and drag the mouse over the squares corresponding to your desired period
4. Repeat step 2 & 3 to set the schedule for other alarm type.
5. The set schedule is valid only for one channel. If you want to use the same recording schedule for other channels, use **Copy** function.
6. Click **Apply** to save your settings.

5.7 - System Configuration

Change general system information such as date, time and region, edit passwords and permissions, system maintenance, and more.

EN

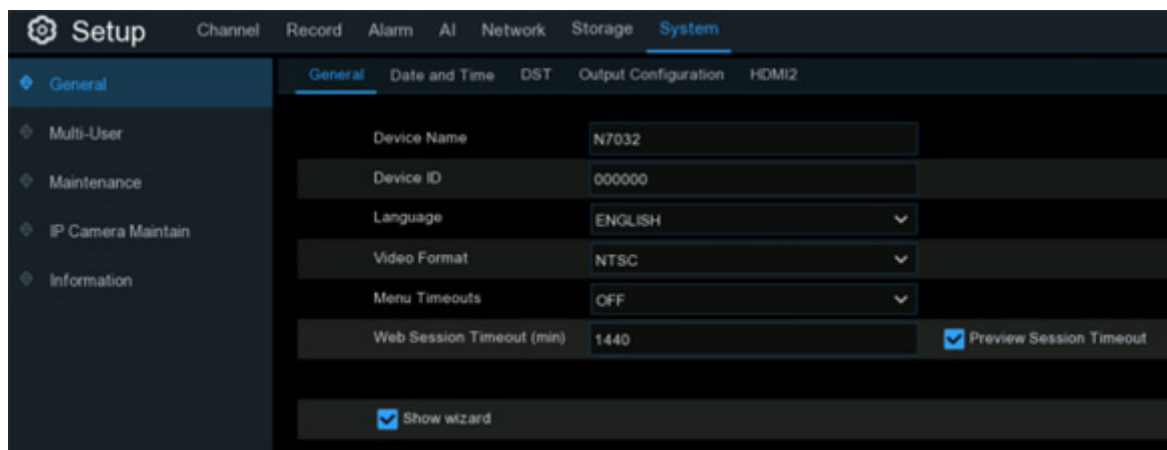

5.7.1 - General Settings

Change general system information such as language, date & time, display settings, and more.

5.7.1.1 - General

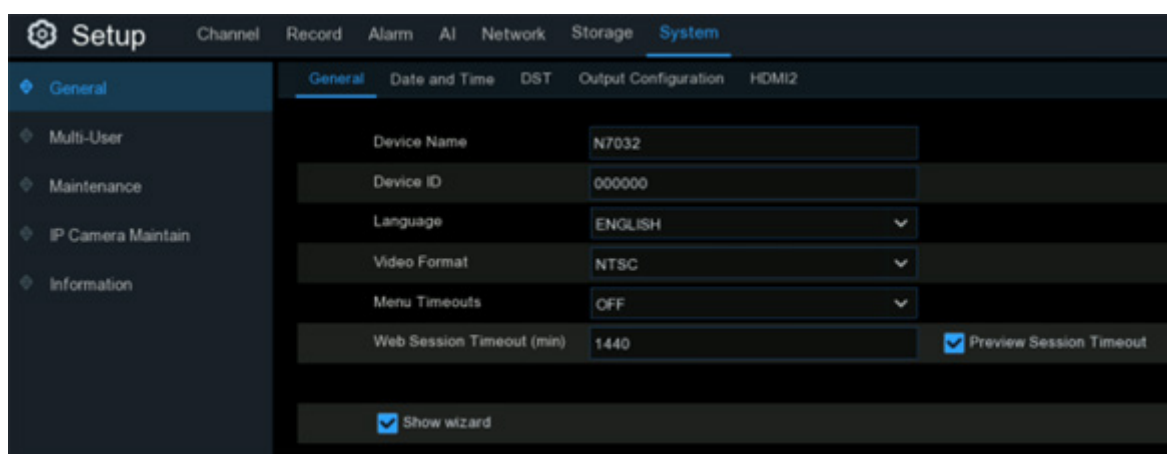

Device Name: To rename your NVR(if required). The name can include both letters and digital numbers.

Device ID: Enter the desired ID for your NVR. The device ID is used to identify the NVR, and can only be composed of numbers. For example, 2pcs NVRs are installed in the same place, the Device ID is 000000 for one of the NVRs, and 111111 for another NVR. When you want to operate the NVR with a remote controller, both of the NVR may receive the signal from controller & act at the same time. If you want to control only the NVR with ID 111111, you can input the Device ID 111111 in login page with remote controller for further operations.

Language: Select a language you would like the system menus to be displayed in. Multiple languages are available.

Video Format: Select the correct video standard for your region.

Menu Timeouts: Click the drop-down menu to select the time your NVR will exit the Main Menu when idle. You can also disable this by selecting "OFF" (password protection will be temporarily disabled).

Web Session Timeouts: Enter the time (in minutes) your NVR will exit web access when idle in the setting page. Adjustable time can be set from 5 minutes to 1,440 minutes. If you tick on the checkbox of "Preview Session Timeouts", the web access will be exited also when idle in the live view page.

Show Wizard: Click the checkbox if you would like to display the Startup Wizard each time you turn on or reboot your NVR.

5.7.1.2 - Date & Time

Date & Time

Date: Click the calendar icon to change the date.

Time: Click the dialogue box to change the time.

Date Format: Select the preferred date format.

Time Format: Select the preferred time format.

Time Zone: Select a time zone relevant to your region or city.

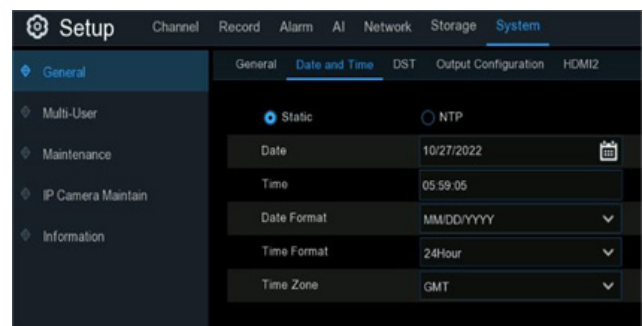

NTP Settings

The NTP (Network Time Protocol) function gives your NVR the ability to automatically sync its clock with a time server. This ensures that the date and time are accurate and ensures correct time stamping when events occur.

Tick the checkbox of **Enable NTP**, and select a **Server Address**, click **Update Now** to manually sync the date & time. When NTP function is enabled, system will update the system time at 00:07:50 per day or every time when the system is starting up. Click **Apply** to save your settings.

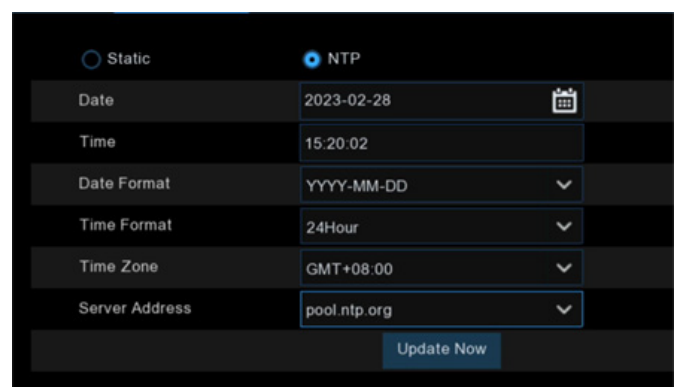

5.7.1.3 - DST

The DST (Daylight Saving Time) function allows you to select the amount of time that Daylight Saving has increased by in your particular time zone or region.

EN

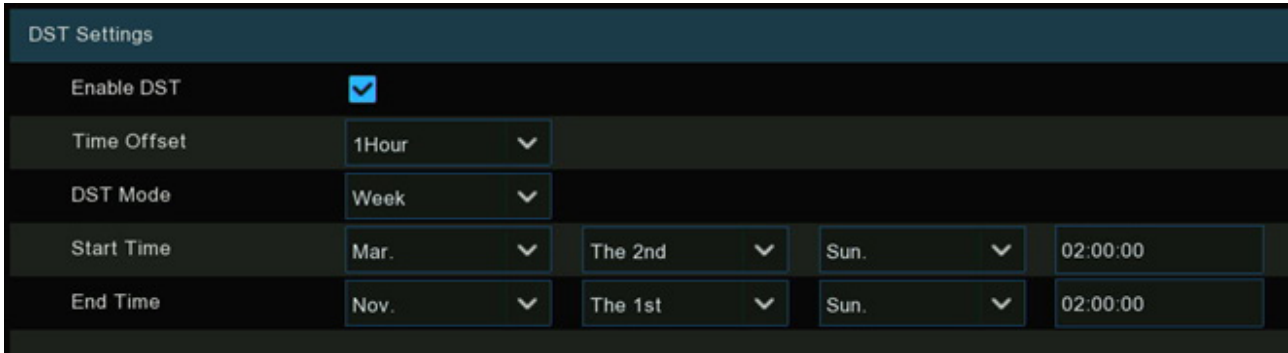

The screenshot shows the 'DST Settings' menu with the following options:

- Enable DST:** A checked checkbox.
- Time Offset:** A dropdown menu set to '1Hour'.
- DST Mode:** A dropdown menu set to 'Week'.
- Start Time:** A row of four dropdown menus: 'Mar.', 'The 2nd', 'Sun.', and '02:00:00'.
- End Time:** A row of four dropdown menus: 'Nov.', 'The 1st', 'Sun.', and '02:00:00'.

Enable DST: If Daylight Saving applies to your time zone or region, click the drop-down menu to enable it.

Time Offset: Select the amount of time that Daylight Saving has increased by in your time zone. This refers to the difference in minutes, between Coordinated Universal Time (UTC) and the local time.

DST Mode: You can select how Daylight Saving starts and ends:

- **Week:** Select the month, a particular day, and time when Daylight Saving starts and ends. For example, 2 a.m. on the first Sunday of a particular month.
- **Date:** Select the start date (click the calendar icon 📅), end date, and time when Daylight Saving starts and ends.

5.7.1.4 - Output Configuration

This menu allows you to configure video output parameters.

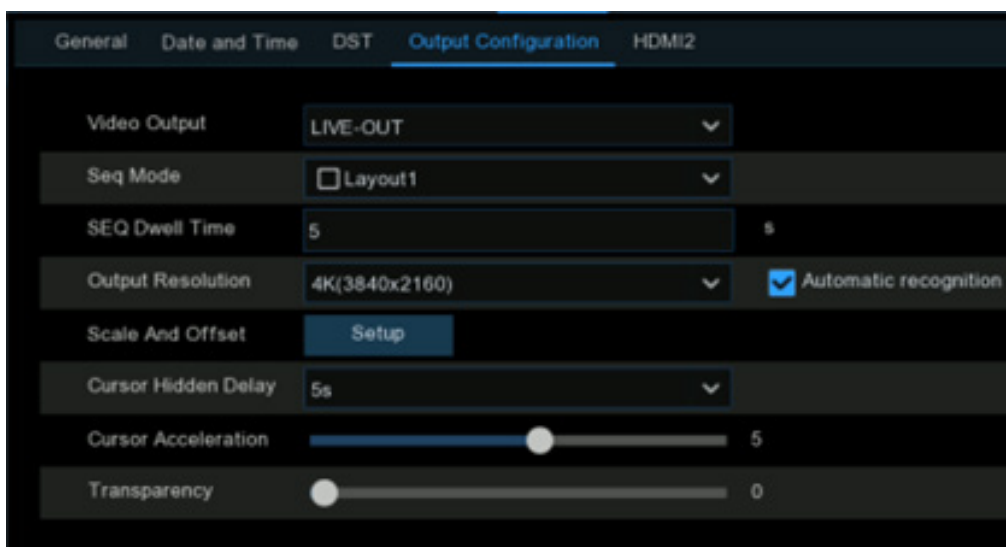

The screenshot shows the 'Output Configuration' menu with the following options:

- Video Output:** A dropdown menu set to 'LIVE-OUT'.
- Seq Mode:** A dropdown menu with a checkbox and 'Layout1' selected.
- SEQ Dwell Time:** A text input field set to '5' with a 's' unit indicator.
- Output Resolution:** A dropdown menu set to '4K(3840x2160)' with a checked 'Automatic recognition' checkbox.
- Scale And Offset:** A 'Setup' button.
- Cursor Hidden Delay:** A dropdown menu set to '5s'.
- Cursor Acceleration:** A slider control set to '5'.
- Transparency:** A slider control set to '0'.

Video Output: Leave the default selection.

SEQ Mode: Select how many video channels you would like to display at a time when your NVR is in sequence mode.

SEQ Dwell Time: Enter in seconds the maximum length of time you would like to display a video channel(s) in sequence mode before displaying the next video channel(s) (300 seconds is the maximum).

VGA/HDMI Resolution: Set the VGA/HDMI output resolution. Check **Auto Recognition** will automatically set the resolution compatible with the monitor you connected when the DVR boots. The system will suggest to modify the resolution if it detects a higher resolution available each time when the system starts.

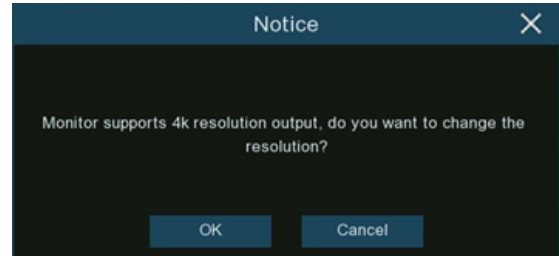

Scale and Offset: To set the image scale and offset. Click **Setup** button to configure.

Scale: To adjust the size of the display window.

X Offset: To move the display window towards left or right.

Y Offset: To move the display window towards up or down.

Tick on ratio button of which you want to set, and then click or long press the ◀ or ▶ button, or using scroll wheel of your mouse to adjust accordingly.

Cursor Hidden Delay: Click the drop-down menu to select the time your NVR will hide the mouse cursor when idle. You can also disable this by selecting **OFF**.

Cursor Acceleration: Adjust the moving speed of the mouse cursor.

Transparency: Click and hold the slider left or right to change how transparent the Menu Bar and Main Menu will appear on-screen. Adjust accordingly.

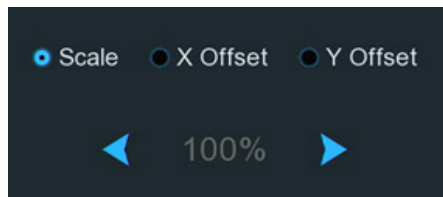

5.7.1.5 - HDMI2

You can set the display output parameters of the secondary screen (only supported by some devices).

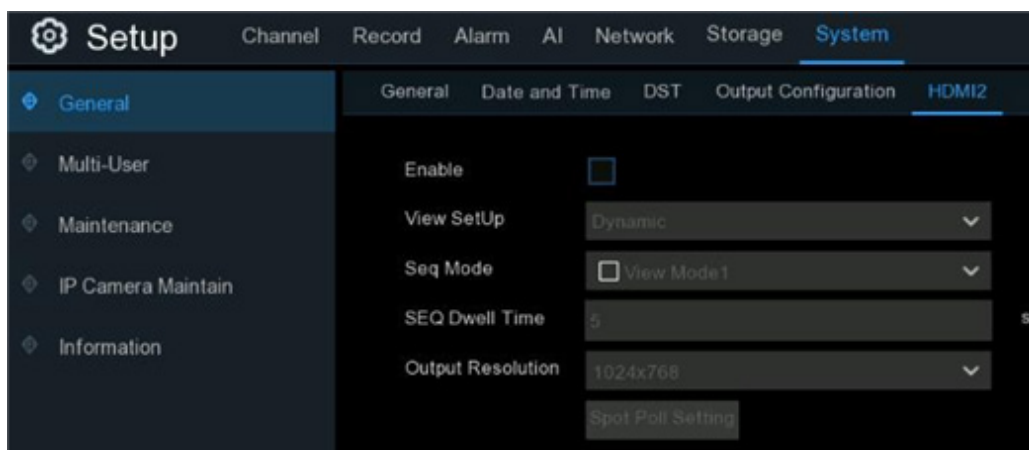

Enable: Used to set whether to enable the secondary screen display.

View SetUP: View setting, including two options: Static and Dynamic. If Dynamic is selected, images are previewed on the secondary screen in a sequential manner.

SEQ Mode: Select the number of video channels to be displayed when the NVR is in HD 2 SEQ mode.

SEQ Dwell Time: Used to set the SEQ dwell time on the secondary screen in seconds.

Output Resolution: Select the display resolution suitable for the secondary screen.

Spot Poll setting: Select the channels for sequential display on the secondary screen in dynamic mode.

5.7.2 - Users

This menu allows you to configure the user name, password and user permission.

DST Settings				
Enable DST	<input checked="" type="checkbox"/>			
Time Offset	1Hour	▼		
DST Mode	Week	▼		
Start Time	Mar.	The 2nd	Sun.	02:00:00
End Time	Nov.	The 1st	Sun.	02:00:00

The system supports the following account types:

ADMIN: System administrator has full control of the system, and can change the password of both administrator and users and enable/disable password protection.

USER: Normal users only have access to live viewing, search, playback, and other functions. You may set up multiple user accounts with varying levels of access to the system.

Default User: Select the default user to login the system when the system starts. Admin is the default user account. If multiple user accounts have been created, click the drop-down menu to turn this off.

5.7.2.1 - Edit Users

You're able to edit the user's password, to enable or disable a user, set the limitation of remote access.

1. Click the User Edit button of the user you want to configure.

No.	User Name	Level	User Enable	User Edit	Permission
1	admin	ADMIN	Enable		
2	user1	USER1	Disable		
3	user2	USER2	Disable		
4	user3	USER3	Disable		
5	user4	USER4	Disable		

2. For the **Admin**, you can proceed:
 - To change **password**: The password must be a combination of 8 to 16 characters, which is combined with at least 2 kinds of different characters from uppercase letters, lowercase letters, digit numbers and special symbols. Enter your new password again to confirm, and then click **Save** to save your new password. You will be required to input your old password to authenticate.
 - To enable or disable **Unlock Pattern**: if this is enabled, you can draw your pattern and save. You can unlock the NVR by drawing the pattern when you login the system next time.
 - To set the **Limitation of Remote Access**: this will limit the maximum number of remote accesses with this user account at the same time. Remote accesses include but not limited to webpage, CMS/VMS, mobile app, 3rd party platform.

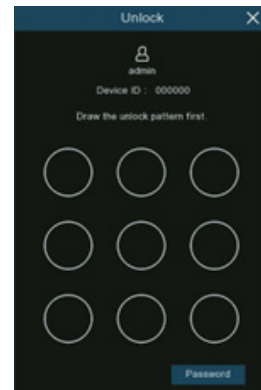
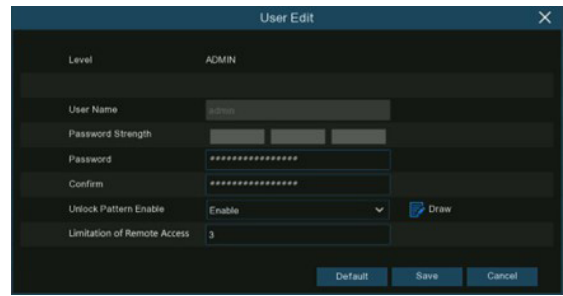

3. For a **normal user**, you can proceed:
 - To enable or disable this user.
 - To give a user name and password to the user.
 - To set the **Limitation of Remote Access**. This will limit the maximum number of remote accesses with this user account at the same time. Remote accesses include but not limited to webpage, CMS/VMS, mobile app, 3rd party platform.

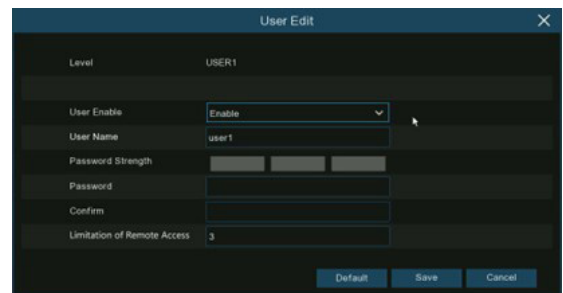

5.7.2.2 - Edit User Permissions

The administrator account is the only account that has full control of all system functions. You can enable or disable access to certain menus and functions of each user account.

1. Click the Permission button of the user you want to configure.

No.	User Name	Level	User Enable	User Edit	Permission
1	admin	ADMIN	Enable		
2	user1	USER1	Disable		
3	user2	USER2	Disable		
4	user3	USER3	Disable		
5	user4	USER4	Disable		

2. Tick the checkbox of any system menus or capabilities you would like the user to access. Click All to check all boxes. Click Clear to check none of the boxes.
3. Click **Save** to save your modifications.

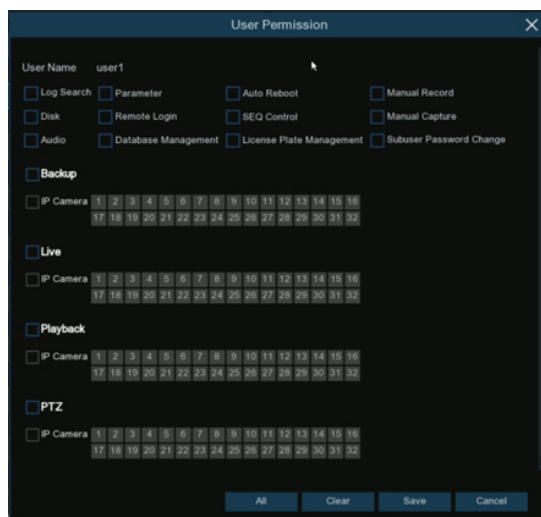

User Permission [X]

User Name: user1

Log Search Parameter Auto Reboot Manual Record
 Disk Remote Login SEQ Control Manual Capture
 Audio Database Management License Plate Management Subuser Password Change

Backup

IP Camera 1 2 3 4 5 6 7 8 9 10 11 12 13 14 15 16
17 18 19 20 21 22 23 24 25 26 27 28 29 30 31 32

Live

IP Camera 1 2 3 4 5 6 7 8 9 10 11 12 13 14 15 16
17 18 19 20 21 22 23 24 25 26 27 28 29 30 31 32

Playback

IP Camera 1 2 3 4 5 6 7 8 9 10 11 12 13 14 15 16
17 18 19 20 21 22 23 24 25 26 27 28 29 30 31 32

PTZ

IP Camera 1 2 3 4 5 6 7 8 9 10 11 12 13 14 15 16
17 18 19 20 21 22 23 24 25 26 27 28 29 30 31 32

[All] [Clear] [Save] [Cancel]

EN

5.7.3 - Maintenance

In this section, you will be able to search & view the system log, load default settings, upgrade the system, export & import system parameters, manager system auto reboot, and more.

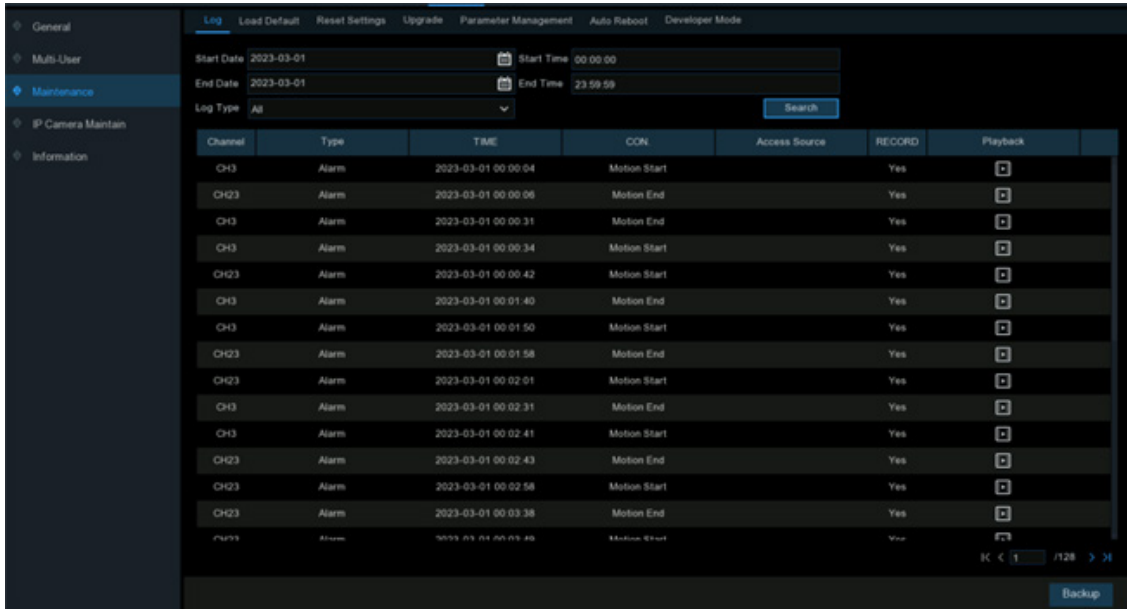

5.7.3.1 - System Log

All actions and events that your NVR performs and detects are logged. These log files can be searched, viewed and copied to a USB flash drive for safekeeping.

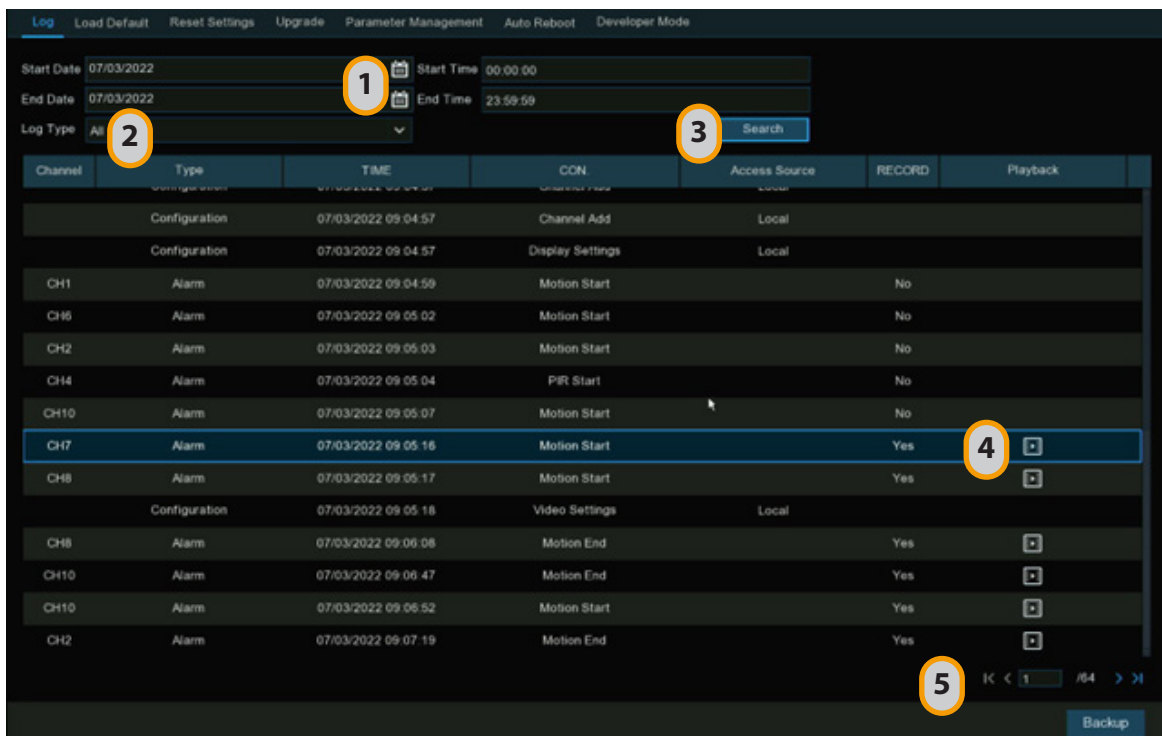

- 1 – **Start/End Date & Start/End Time:** Click the calendar icon to select the month, year and date that you would like to search on. Click the dialogue box to enter a specific start and end time.
- 2 – **Log Type:** Leave the default selection or click the drop-down menu to select a specific action that you would like to search for.
- 3 – **Search:** Click this to display a list of log files that match your search criteria. Double-click a file to display information about that log.
- 4 – **Playback:** Click play button  to play the video segment of the event.
- 5 – Click the arrow buttons to turn the page of the search list.
- 6 – **Backup:** Insert a USB flash drive into your NVR, then click this to copy the log files that match your search criteria.

5.7.3.2 - Load Default

Reset the NVR settings to its out-of-box state. You can choose to reset all settings at once, or just settings on specific menus. Restoring default settings will not delete recordings and snapshots saved to the hard drive.

Tick the checkbox of the item(s) you want restore, or check **Select All** to choose all items.

Click **Apply** to load default settings of your chosen items.



5.7.3.3 - Reset Settings

If your NVR comes with a reset button on the rear panel, you will see this menu.

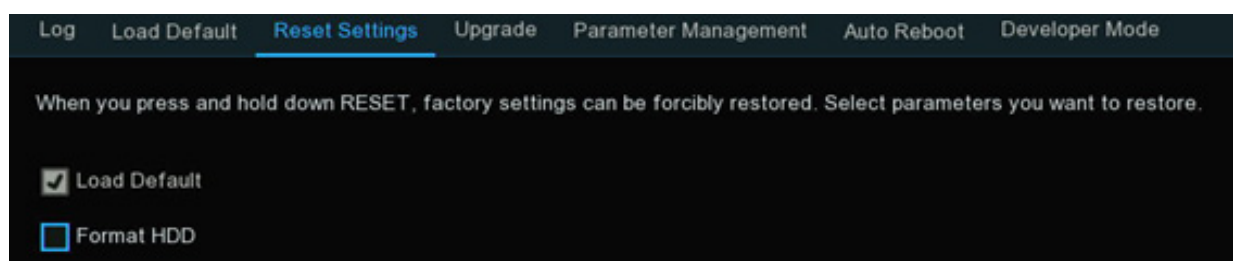

By default, when you press and hold 10 seconds on the reset button with a small pin till the NVR beeps, the NVR will restore default settings. You can tick the checkbox to format HDD if needed.

5.7.3.4 - System Upgrade

You can upgrade the firmware by USB flash drive or online.

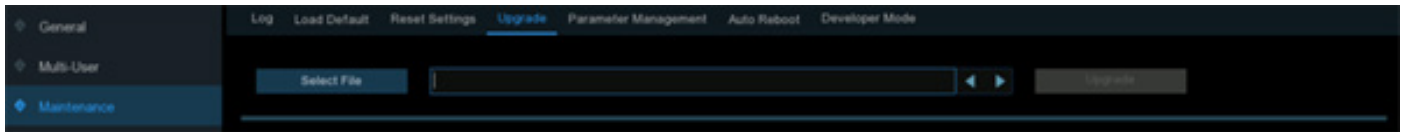

5.7.3.4.1 - Upgrade by USB Flash Drive

1. Copy the firmware file (generally it is ended with ".sw") to your USB drive, and insert the USB flash drive into the NVR's USB port.
2. Click **Select File** button to choose the firmware file in your USB flash drive, then Click **OK**.
3. Click **Upgrade** button to start firmware upgrade. The upgrade will last around 5-10 minutes, please do **NOT** power off the NVR or remove the USB from NVR during firmware upgrade.
4. The NVR will reboot after upgrade finished.

5.7.3.4.2 - Online Upgrade

The device supports over-the-air upgrade. To use this function, you need to set up the upgrade server in advance, create a directory for storing files on the server, and upload the upgrade firmware.

Username: Used to set the server user name. If the server is not configured with any user, the parameter value can be null.

Password: Used to set the server password. If the server is not configured with any password, the parameter value can be null.

Server Address: Used to set the server address. You need to set the upgrade address to the directory for storing the upgrade files.

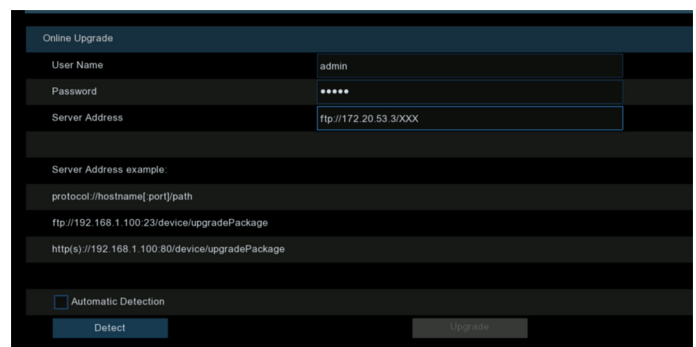

The screenshot shows the 'Online Upgrade' configuration page. It has fields for 'User Name' (admin), 'Password' (masked with dots), and 'Server Address' (ftp://172.20.53.3/XXX). Below these fields is an example of a server address format: 'protocol//hostname[:port]/path'. Two example addresses are provided: 'ftp://192.168.1.100.23/device/upgradePackage' and 'http(s)://192.168.1.100.80/device/upgradePackage'. At the bottom, there is an 'Automatic Detection' checkbox and two buttons: 'Detect' and 'Upgrade'.

Automatic Detection: If this option is selected, the device will periodically check and upgrade the firmware on the server at startup and during operation. If there is upgradeable firmware, a prompt message will pop up.

Detect: Click this button to manually detect whether the server has upgradeable firmware.

Upgrade: When it is detected that the server has upgradeable firmware, this button is available. You can click it to confirm the upgrade operation on the device.

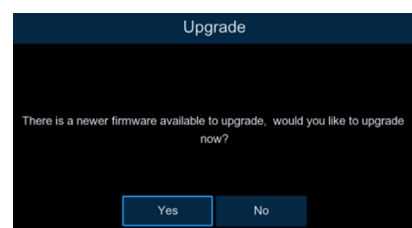

5.7.3.5 - Parameter Management

You can export the system settings to a USB flash drive, or import a system setting file from USB flash drive to the NVR.

Save Settings: Click this button to **export** a configuration file containing all the settings that you have customized.

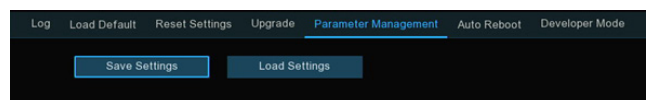

Load Settings: Click this button to **import** a configuration file containing all the settings that you have customized.

5.7.3.6 - Auto Reboot

This menu allows the system to auto reboot the NVR regularly. It is recommended to leave this function enabled, as it maintains the operational integrity of your NVR.

Auto Reboot: Tick to enable.

Time: You can set the NVR to reboot by day, week or month.

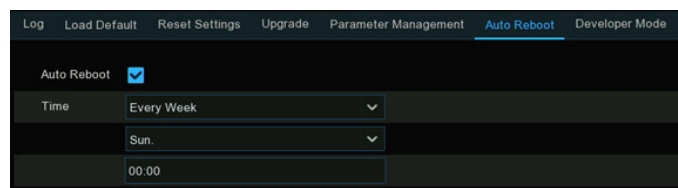

5.7.3.7 - Developer Mode

This is an advantage feature on some certain models, which is used to acquire debug log for authorized professionals when you report a defective complaint.

Telnet: This is used for an authorized technician to connect to your NVR remotely. Please keep it disabled unless you're required by an authorized technician.

Debug Log: It is used for authorized professionals to learn the system running status

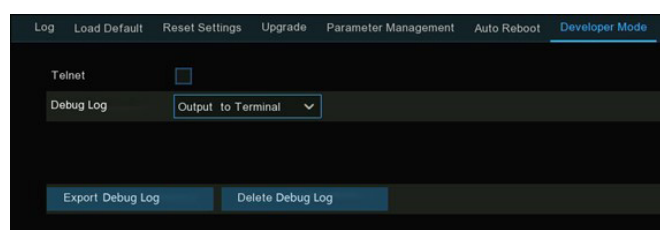

- **Disabled:** Debug log won't be saved.
- **Output to Terminal:** Debug log will be outputted to terminal port.
- **Output to Disk:** Debug log will be saved to hard disk drive.

Export Debug Log: Export the debug log file from hard disk drive to your USB flash drive.

Delete Debug Log: Delete the debug file from the hard disk drive.

5.7.4 - IP Camera Maintain

This menu allows you to upgrade IP camera's firmware or restore default settings of IP camera.

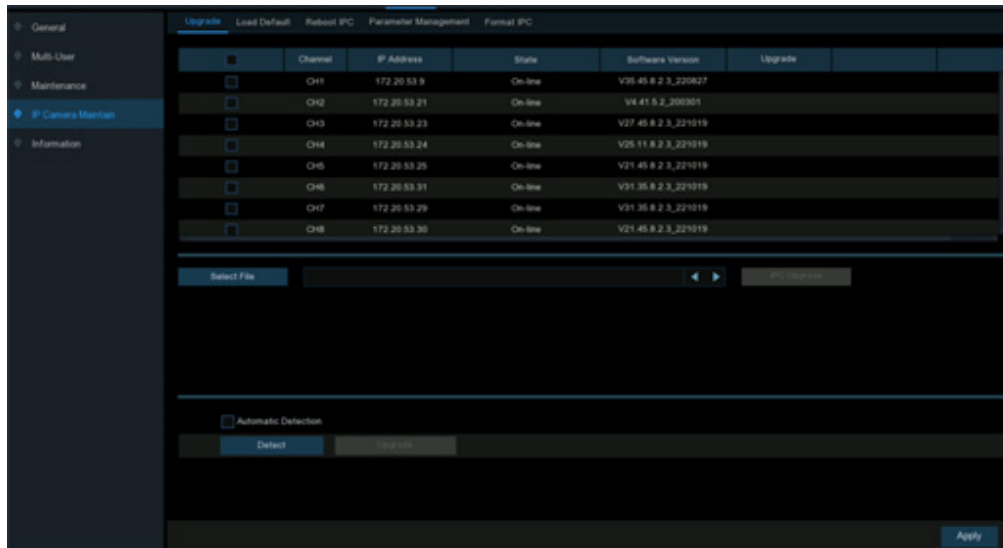

5.7.4.1 - Upgrade IP Camera

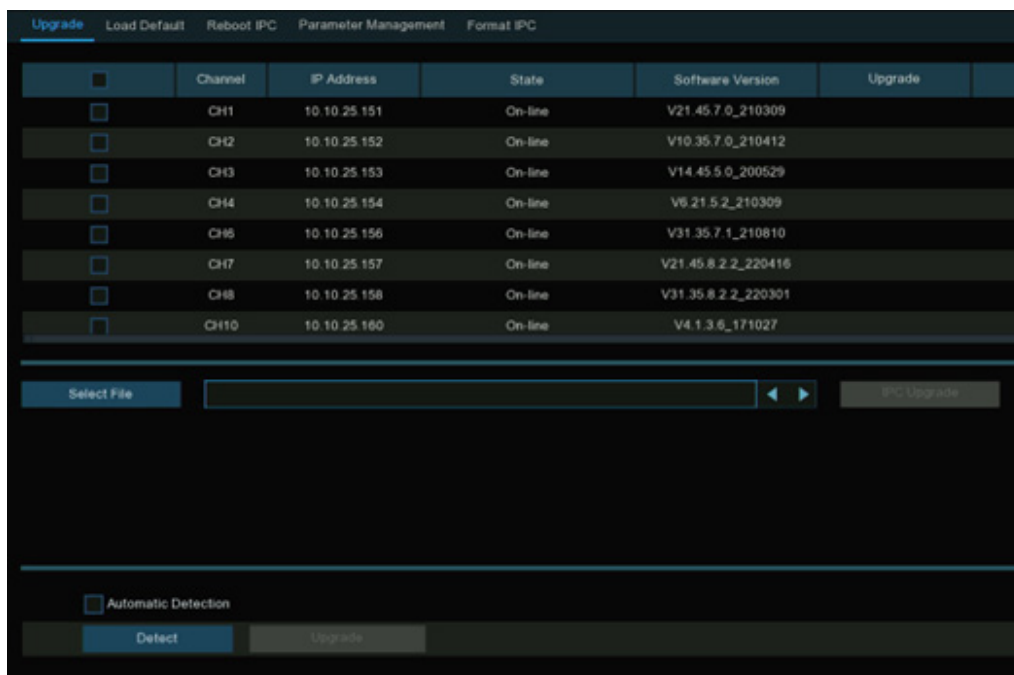

1. Choose one of the IP cameras you want to upgrade firmware.
2. Click **Select File** select the update file from your USB flash drive, then click **OK**.
3. Click **IPC Upgrade** button to start upgrading. You will be required to input the Admin's password to authenticate. Please do **NOT** power off the NVR and IP camera or remove the USB during the upgrading.

For some certain IP cameras which support online upgrade, you can tick **Automatic Detection** if you want to automatically check the upgrade file from server at regular intervals. Click **Detect** button to check if new firmware is available instantly. If new firmware is available, follow the on-screen instructions.

5.7.4.2 - Load Default Settings of IP Camera

1. Choose the IP camera(s) you want to restore.
2. Click **Load Default** to restore settings. You will be required to input the Admin's password to authenticate.

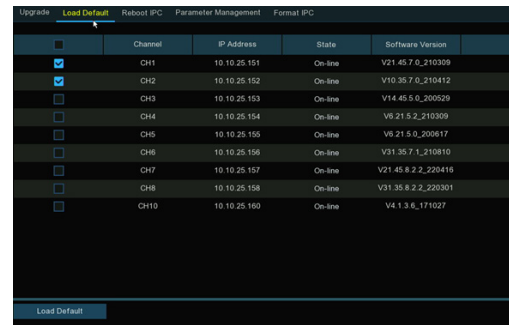

EN

5.7.4.3 - Reboot IP Camera

In case of any issues, choose the camera(s) and then click **Reboot IPC** button to reboot selected camera(s).

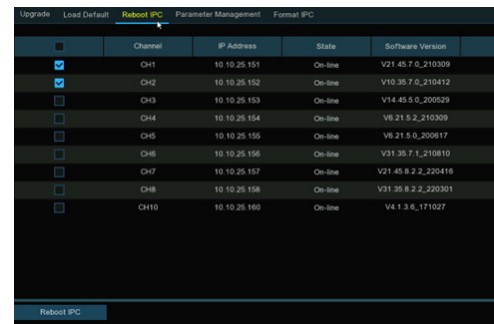

5.7.4.4 - Parameter Management

Select the camera(s), and then click **Save Settings** to export the configuration file containing all the settings that you have customized to your USB flash drive.

Load Settings: Click this button to import a configuration file containing all the settings that you have customized and apply to the selected camera(s).

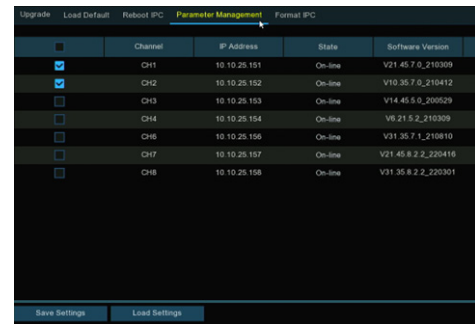

5.7.4.5 - Format IP Camera

To format the SD card installed on the supported IP camera.

Select the camera, and then click **Format** to format its SD card.

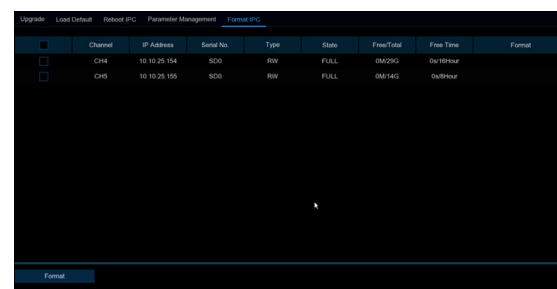

5.7.5 - System Information

In the System Information menu, you can view the system information, channel information, record information & network status.

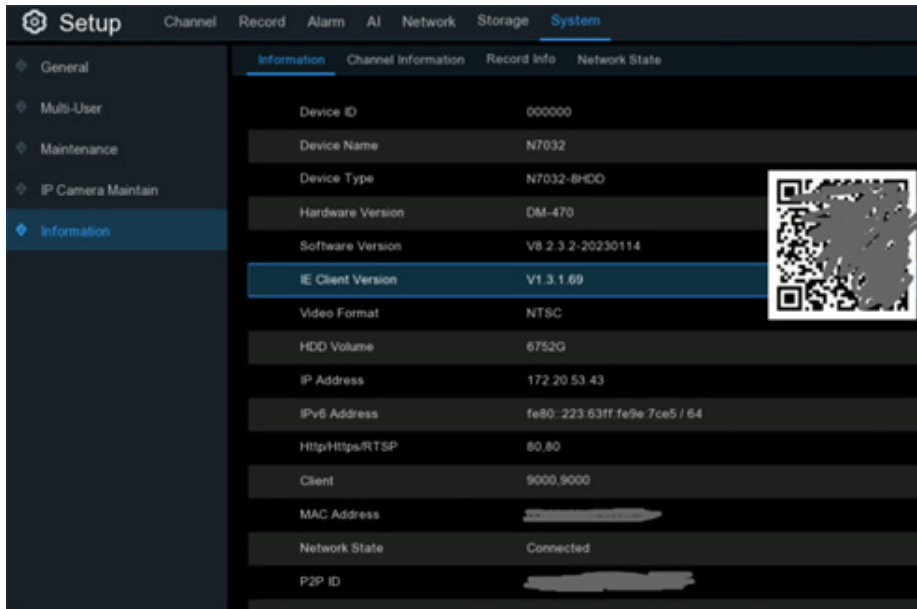

5.7.5.1 - System Information

This tab displays technical information about your NVR, such as hardware/software version, IP address, network ports, MAC address, etc.

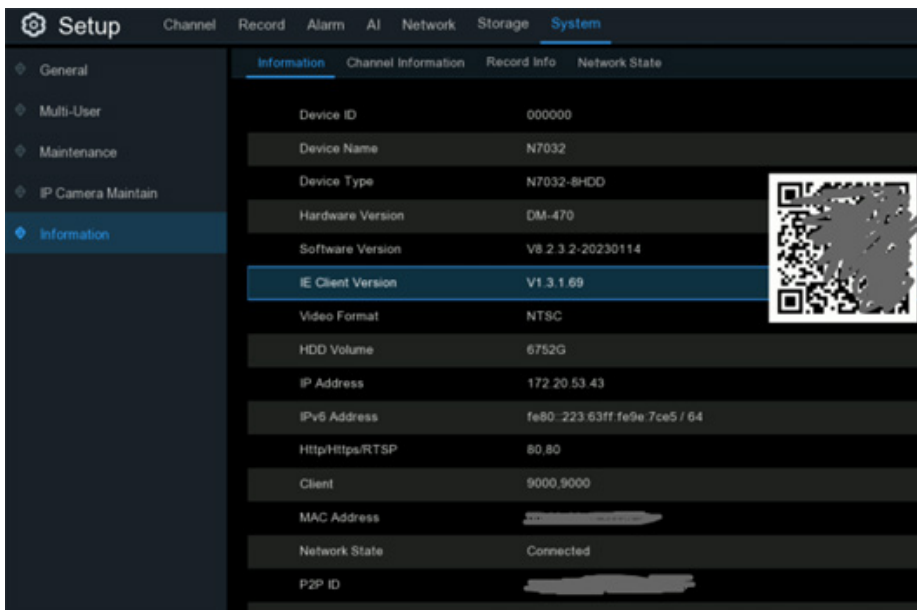

If your NVR supports P2P function, you will find the P2P ID & P2P QR code in the information page. You can scan this QR code with mobile app to remote view the NVR.

5.7.5.2 - Channel Information

View channel information for each connected camera such as alias, mainstream and substream recording specifications, motion detection status & privacy zone.

EN

Channel	Alias	State	Mainstream	Substream	Mobliestream	Motion Detection	Privacy Zone
CH1	CH1	On-line	2592x1944, 30Fps, 4Mbps	1280x 720, 20Fps, 1024Kbps	640x 480, 10Fps, 512Kbps	Support	Support
CH2	CH2	On-line	1920x1080, 25Fps, 4Mbps	1280x 720, 20Fps, 1024Kbps	640x 480, 25Fps, 512Kbps	Support	Support
CH3	CH3	On-line	3840x2160, 15Fps, 4Mbps	1280x 720, 10Fps, 1.5Mbps	Nonsupport	Support	Support
CH4	CH4	On-line	2592x1944, 15Fps, 4Mbps	640x 480, 15Fps, 2Mbps	Nonsupport	Support	Support

5.7.5.3 - Record Information

View recording information for each connected camera such as bitrate, stream type, recording resolution and frame rate (FPS).

Channel	Record State	Record Switch	Stream Type	Resolution	FPS	Bitrate
CH1	ON	Enable	DualStream	2592x1944 1280x720	30Fps 20Fps	4Mbps 1024Kbps
CH2	ON	Enable	DualStream	1920x1080 1280x720	25Fps 20Fps	4Mbps 1024Kbps
CH3	ON	Enable	DualStream	3840x2160 1280x720	15Fps 10Fps	4Mbps 1.5Mbps
CH4	ON	Enable	DualStream	2592x1944 640x480	15Fps 15Fps	4Mbps 2Mbps

5.7.5.4 - Network State

Displays the network settings used by your NVR.

Total Bandwidth: Total input bandwidth available for the NVR.

Used Bandwidth: Used input bandwidth.

Attribute	Value
WAN	
IP Address	192.168.5.110
Subnet Mask	255.255.255.0
Gateway	192.168.5.1
MAC Address	00-23-63-91-5B-FC
IPv6 Address	fe80::223:63ff:fe91:5bfc / 64
IPv6 Gateway	fe80::/64
DHCP	Disable
Internal Interface	
Internal Interface	Connected
IP Address	10.10.25.100
Subnet Mask	255.255.0.0
DNS1	172.18.1.222
DNS2	8.8.8.8
PPPoE	Disable
Port	
Http/Https/RTSP	13180,13180,Inactive,Disable
Client	13181,13181,Inactive,Disable
Total Band Width:	256Mbps
Used Band Width:	58.488Mbps

6 - AI SCENARIO

AI Scenario function provides AI applications for different specific scenarios. Click the submenu title in the main setup page to get into the individual function setup page.



6.1 - Cross Counting

This is an AI application based on cross counting function, which helps to control the attendance number of customers/visitors/vehicles in public places, like restaurants, parks, zoos, theaters, museums, car parks, etc.

The interface displays real-time cross counting data for multiple channels (CH1, CH2, CH6, CH7) and a detailed view of a specific channel (CH1).

Channel Summary Data:

Channel	Type	06:00	07:00	08:00	09:00	10:00	11:00
CH1	Enter	0	0	0	0	0	19
	Exit	0	0	0	0	0	11
	Inside	0	0	0	0	0	8
CH2	Enter	0	0	0	0	0	7
	Exit	0	0	0	0	0	3
	Inside	0	0	0	0	0	4
CH6	Enter	0	0	0	0	0	72
	Exit	0	0	0	0	0	68
	Inside	0	0	0	0	0	4
CH7	Enter	0	0	0	0	0	48
	Exit	0	0	0	0	0	30
	Inside	0	0	0	0	0	18

Channel 1 Detailed View:

Please Enter





992 Available

8 Inside 19 Enter 11 Exit

6.1.1 - Real-Time Display & Controls

1 – Navigation Bar

EN

Button	Function
	Channel View Mode: To count and view the real-time result by individual camera(s). Mostly used for small place with single entrance & exit.
	Group View Mode: To count and view the real-time result by group(s). Mostly used for big place with multiplex entrances & exits which are monitored by multiplex cameras.
	Data Search: To search the counting data
	Configuration: To configure the settings

2 – 2 - Real-Time Counting Statistics





Available: Remaining allowed attendance number

Inside: Current attendance number inside the control area

Enter: Recorded number of total entrants

Exit: Recorded number of total leaving attendance.

3 – Screen Display Controls

Button	Function
	Screen display layout of 4/6/9 channels. Continuously click a button to display next page.
	To show or hide the real-time data display.
	Clear counting data for the selected channel
	Clear counting data for all channels

4 – Real-Time Counting Statistics Information Bar

This bar will display the real-time counting statistics for the selected channel.

Available: Remaining allowed attendance number

Inside: Current attendance number inside the control area

Enter: Recorded number of the total entrants

Exit: Recorded number of the total leaving attendance.



If the available number is more than 0, the cartoon figure will be in green color.



If the available number is 0, the cartoon figure will be in red color.

5 – Statistics Data Chart

The all-day counting statistical data of all activated channels will be displayed here. Use the mouse wheel to move the timeline toward left or right.

Channel	Type	09:00	10:00	11:00	12:00	13:00	14:00
CH1	Enter	0	0	34	48	29	21
	Exit	0	0	28	8	15	17
	Inside	0	0	6	46	60	64
CH2	Enter	0	0	38	5	28	42
	Exit	0	0	27	16	28	29
	Inside	0	0	11	0	0	13
CH6	Enter	0	0	183	53	239	296
	Exit	0	0	165	63	210	293
	Inside	0	0	18	8	37	40
CH7	Enter	0	0	134	47	152	197
	Exit	0	0	118	63	147	197
	Inside	0	0	16	0	5	5

6 – Full Screen Display

Click the  button to display the Real-time Counting Statistics Information Bar in full screen.

Right click your mouse to **exit**.

6.1.2 - Settings of Channel View Mode

- 1 – Click the add icon **+** or setup icon **⚙** to go to the configuration page.
 - 2 – Tick the checkbox of **Enable** of the channel(s) you want to realize the counting. The Setup & Alarm icon **⚙** will be in blue color if the camera in that channel supports AI function; on the contrary if the camera doesn't support AI function, the icon **⚙** will be in grey color.
 - 3 – Set the **Capacity** number for each channel, which is the maximum limitation of the attendance.
 - 4 – Click the **Setup** button **⚙** of the camera that you want to configure the detection conditions. Check more on 5.4.1.5. CC (Cross Counting Detection).
 - 5 – Click the **Alarm** setup button **⚙** of the camera that you want to configure the alarm actions when the Available number is 0.
 - **Buzzer:** Set the buzzer duration in seconds when the Available number is 0.
 - **Alarm Out:** If your NVR support to connect to external alarm device, you can set to emit an alarm tone.
 - **Latch Time:** To configure the external alarm time when the Available number is 0.
- Right click your mouse to exit the alarm setup page, and then click **Save** button to save the settings.
- 6 – Click **Apply** to save.
 - 7 – Click the **Channel View** icon **📺** to view the live images & counting data of all activated channels.

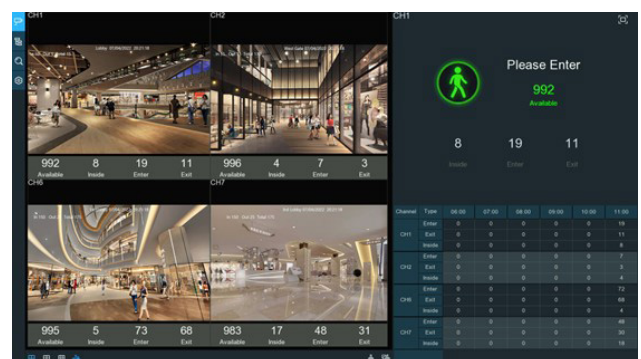
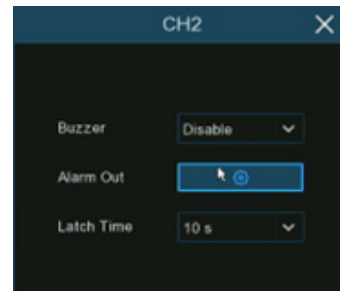
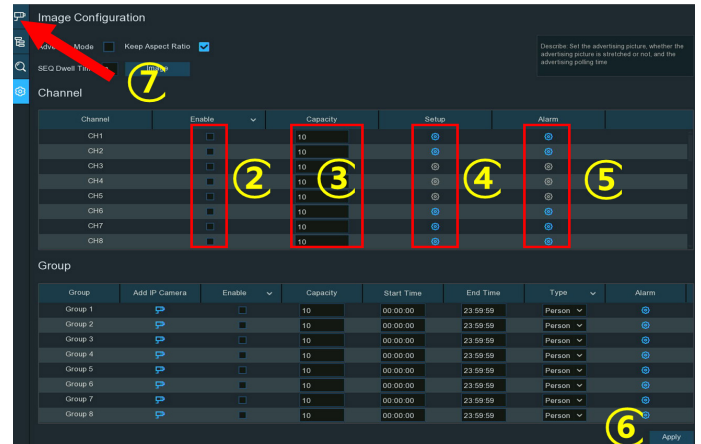
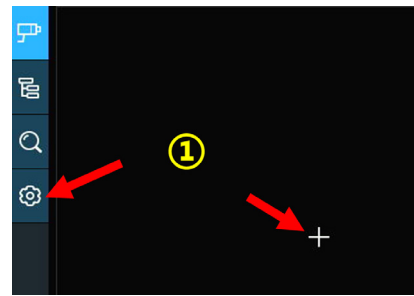

6.1.3 - Settings of Group View Mode

- 1 – Click the add icon or setup icon to go to the configuration page.
- 2 – Click the Add IP Camera icon to add channel(s) to the group. Max. 8 groups can be set, and each individual channel can be added to 1 group only. If a channel is enabled in the Channel View mode, it will be not allowed to add to any group.
- 3 – Tick the checkbox of **Enable** of the group you want to activate.
- 4 – Set the **Capacity** number for each group, which is the maximum limitation of the attendance.
- 5 – Set the **Start/End Time** of each group.
- 6 – Choose the detection targeted **Type** from **Person, Vehicle** or **Motion**.
- 7 – Click the **Alarm** setup button of the group that you want to configure the alarm actions when the Available number is 0.
 - **Buzzer:** Set the buzzer duration in seconds when the Available number is 0.
 - **Alarm Out:** If your NVR support to connect to external alarm device, you can set to emit an alarm tone.
 - **Latch Time:** To configure the external alarm time when the Available number is 0.
 - Right click your mouse to exit the alarm setup page, and then click **Save** button to save the settings.
8. Click **Apply** to save.
9. Click the **Group View** button to view the live images & counting data of all activated groups.
10. You can choose which group you want to view the real-time live images and counting data.
11. Furthermore, it supports to display the counting data in Map mode. Click the **Map** button to configure the settings.

Click button to add a map image from your USB memory.

Click button to adjust the site of the IP cameras. Click and hold the channel icon and move one by one to adjust the position of your IP cameras on the map.



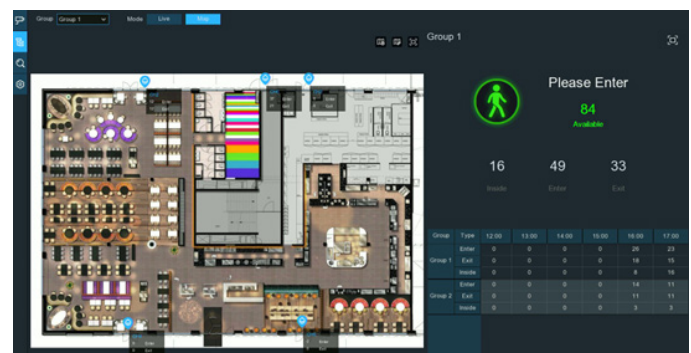
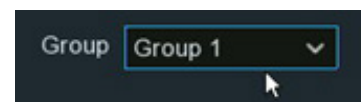
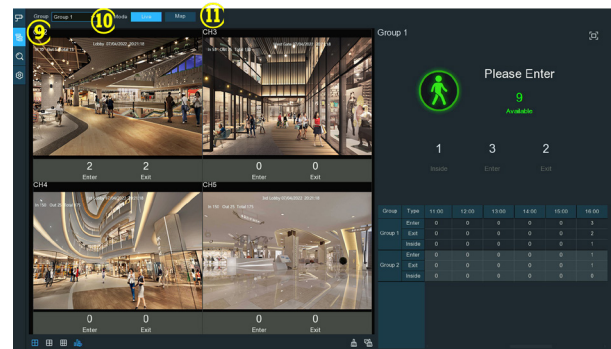
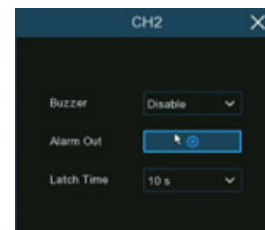
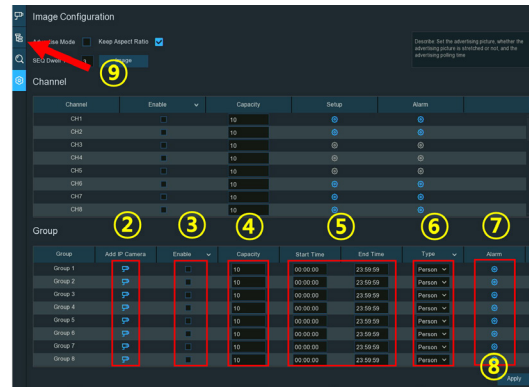
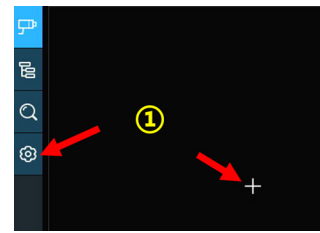

You can click button to display the map in full screen, click button to exit full screen.



6.1.4 - Advertise Mode



The system supports to demonstrate your advertising pictures with the Cross Counting functions.

EN

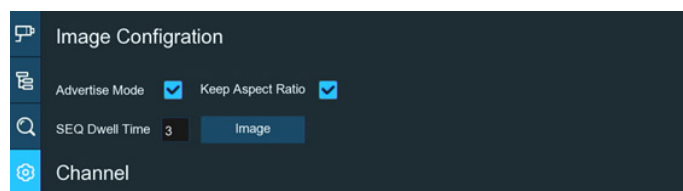



1. Click the **Configuration** button  in the Navigation bar to go to the configuration page.
2. Tick the checkbox of **Advertise Mode**
3. Click **Image** button to load advising pictures from your USB flash drive. It supports to add maximum 16 pictures with jpg, png or bmp format, and the maximum resolution should be no more than 2560x1600. Click the add button  to add new picture(s) and click delete icon  to delete the added picture one by one. Click the close button  or right click your mouse to go back to previous configuration page.
4. Tick the checkbox of **Keep Aspect Ratio** if you want to display the images with their original aspect ratio. Uncheck the box if you want the pictures to be stretched and displayed full screen.
5. Set the **SEQ Dwell Time** in seconds which will decide how long each picture will stay in the screen.
6. Click **Apply** button to save your settings.
7. Go back to Channel View mode or Group View mode, click the full screen button  on the right upper corner to display your advertising pictures and the real-time counting data for the selected channel(s) or group(s).



6.1.5 - Search Counting Data

1. Click Search button  in the Navigation bar to search page.
2. It is allowed to search for Channels or Groups separately. Choose the channel(s) or group(s) you want to search, set the search duration by day, by week, by month or by year and then choose the targeted type you want to search. Click the search button , the result will be displayed on the right side of the window.





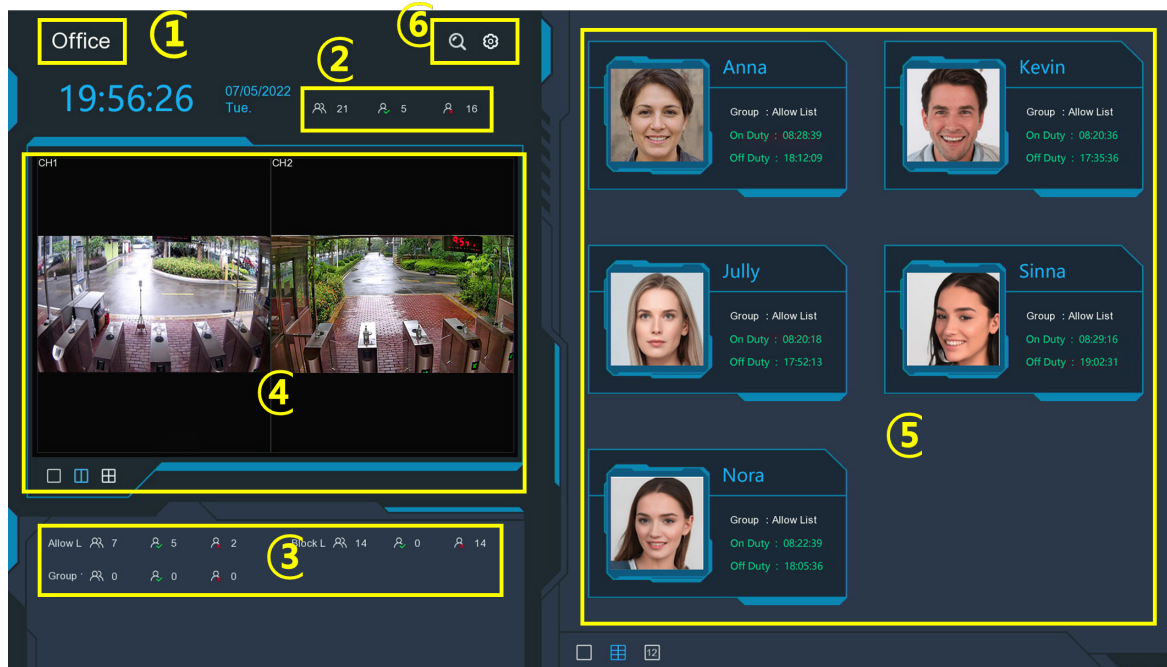

-  Click to display the result in column chart
-  Click to display the result in tendency chart
-  Click to display the result in detail chart
-  Click to export the result into your USB flash drive

6.2 - Face Attendance

Face Attendance is an AI application based on face detection function. You're able to view and check the real-time statistical data of attendance management visually.



- 1 – Customized title of the face attendance.
- 2 – Overall attendance statistical data of all selected groups.
- 3 – Individual attendance statistical data of each selected group:
- 4 – The total number of people who need to check attendance
- 5 – The number of people who have checked attendance already
- 6 – The number of people who haven't checked attendance.
- 7 – Live view screen: to display the live camera images. Click the screen split buttons to change the display layout. Continuously click a button to display next page.
- 8 – Push notifications of latest persons who have checked the attendance, including the Name/ ID of the person, captured face image, group, clock in time and clock out time. Normal clock in & clock out time will be displayed in green color. Abnormal check-in & check-out time will be displayed in red color. Click the screen split icons to change the display layout.
- 9 – Click search icon to search the face attendance data. Check more on 7.1.9.6 Face Attendance.

- 10 – Click Setting icon  to configure the face attendance settings:
- 11 – **Channels:** Click to choose face attendance channel(s)
- 12 – **Group:** Click to choose face attendance group(s). If you want to edit the group database, click the  icon to edit. Check more on 5.4.2.2. Face Recognition Database Management.
- 13 – **GUI Theme:** To give a customized title to the face attendance.
- 14 – **On Duty Time:** To set the on-duty time.
- 15 – **Off Duty Time:** To set the off-duty time.
- 16 – **Email Configuration:** To send the attendance statistical data by email. click the  icon to edit the email configuration.
- 17 – **Enable:** Check the box if you want to send the attendance statistical data by email.
- 18 – **Send Email:** Set the preset time for sending the email.
- 19 – **Mode:** Choose to send the email once in every **Day**, every **Week**, or every **Month**.
- 20 – **Day:** Send the attendance statistical data of previous day once a day.
- 21 – **Week:** Send the attendance statistical data of last 7 days once a week.
- 22 – **Month:** Send the attendance statistical data of last month once a month.
- 23 – **Working Days:** To select the working days. It will affect the attendance statistical data.
- 24 – Click the setting  button to configure your email configuration. Check more on 5.5.3.1 Email Configuration.

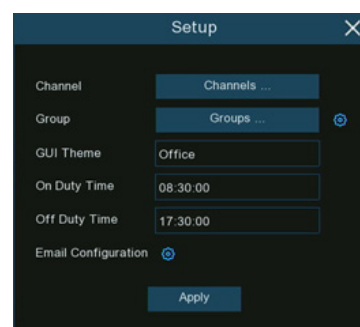

EN

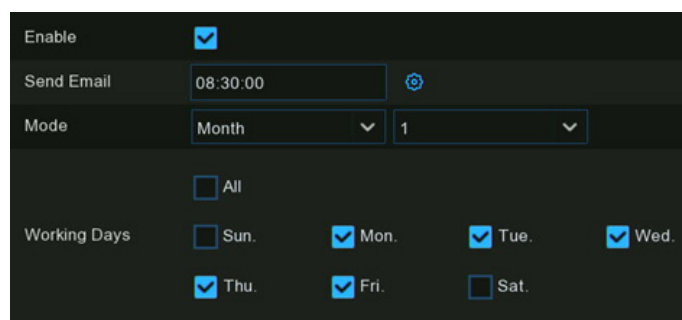

6.3 - Object Classification

Object Classification is an AI application based on face detection, human and vehicle function, which is used to classify and count the number of detected faces, human beings, motor vehicles and non-motor vehicles in a certain period.

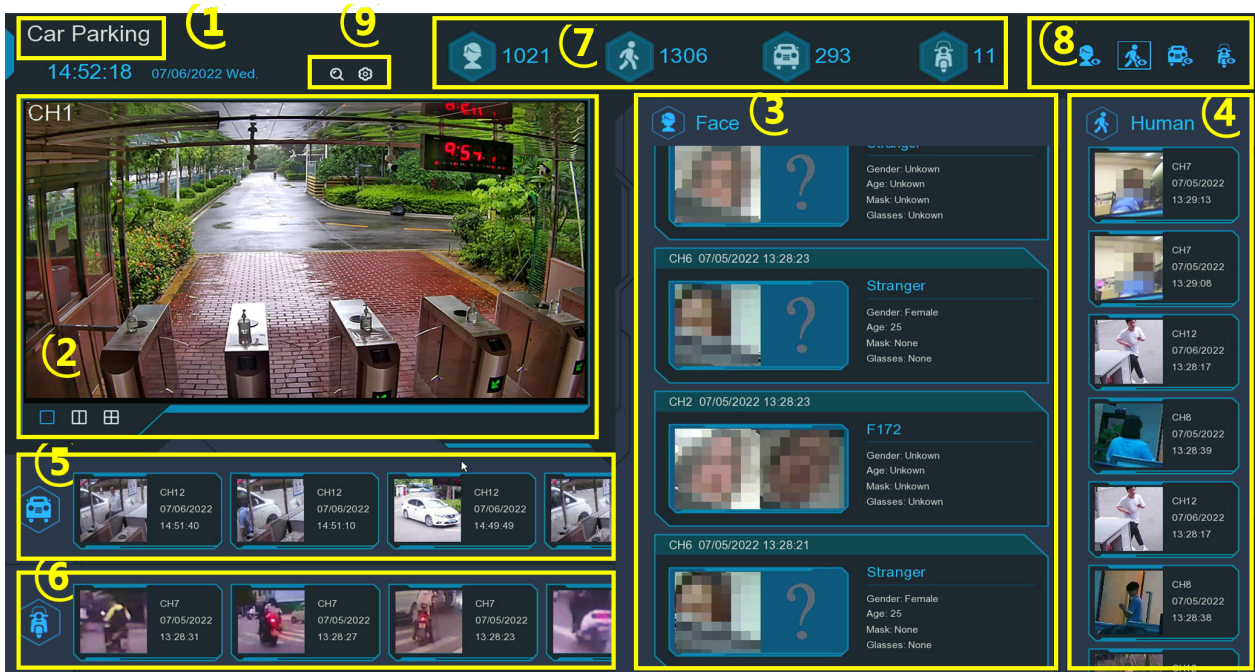

- 1 – Customized title of the object classification.
- 2 – Live view screen: to display the live camera images. Click the screen split buttons to change the display layout. Continuously click a button to display next page.
- 3 – Notifications of detected face images. Use the mouse wheel to move up and down.
- 4 – Notifications of detected human images. Use the mouse wheel to move up and down.
- 5 – Notifications of detected motor vehicles. Use the mouse wheel to move left and right.
- 6 – Notifications of detected non-motor vehicles. Use the mouse wheel to move left and right.
- 7 – Statistical data of detected objects in a selected period.
- 8 – Click the icons to display or hide relative object:
 - To display or hide face images.
 - To display or hide human images.
 - To display or hide motor vehicle images.
 - To display or hide non-motor vehicle images.
- 9 – Click search icon to search the recording of human & vehicle detection events. Check more on 7.1.9.3 Human & Vehicle. Click Setting icon to configure the object classification settings:
 - **GUI Theme:** To give a customized title to the object classification.
 - **Statistics:** To select the time period you want to show the data.
 - **Channels:** Click to choose channel(s) of which you want to show the data

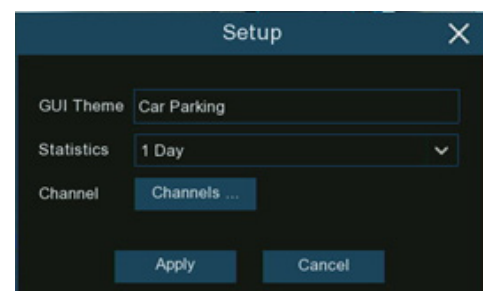

7 - SEARCH, PLAYBACK / BACKUP

The Search function gives you the ability to search for and play previously recorded videos as well as snapshots that are stored on your NVR's hard drive(s). You have the choice of playing video that matches your recording schedule, manual recordings or alarm events. The Backup function gives you the ability to save important events (both videos and snapshots) to a USB flash drive.

EN

Click Search button in the Start Menu to enter search section.



7.1 - Search & Play in General

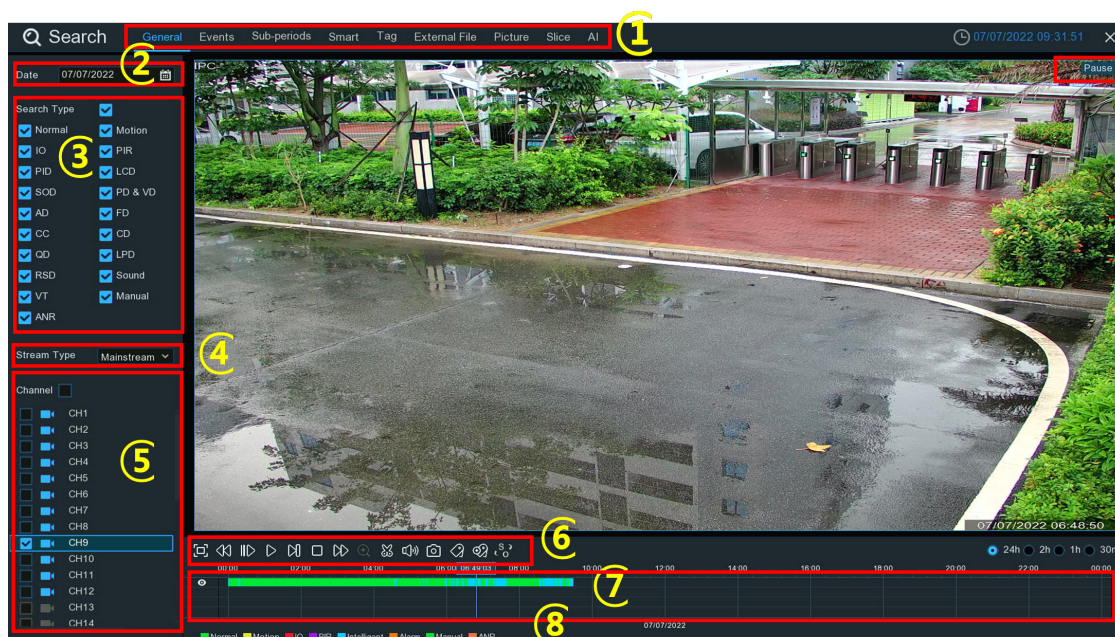

- 1 – **Search Options:** the system provides various search & playback methods: General, Events, Sub-periods, Smart, Tag, External File, Picture, Slice & AI. Click the tab to search different event recordings.
- 2 – **Search Date:** click the calendar icon to select a date to search on. A red underline on a date indicates recordings on those particular dates.
- 3 – **Search Type:** this is the event type that you can search for. You can leave all event types enabled if you want to search for all, or you can select specific event types to narrow your search.
- 4 – Select the video stream to search for. Mainstream is the default option. Substream can be selected if dual-stream recording is enabled.
- 5 – **Channel Selection:** to choose the channels you want to search & play.
- 6 – **Playback Control Bar:** to control the video playback.



Button	Function
	Enlarge the video playback to full screen
	Rewind button, subsequent presses of the button will change the rewind speed.
	Slow Play, subsequent presses of the button will change the play speed
	Play in normal speed
	Pause
	Play frame by frame. Click once to play a frame of the video
	Stop playing
	Fast forward button, subsequent presses of the button will change the speed.
	Select a camera, click this button then use the scroll button on the mouse to zoom. Use the picture-in-picture screen to select a different area to view. Right-click to exit.
	This button allows you to edit the video by setting mark in and mark out points which you can then copy to a USB flash drive. View more on 7.1.1. Video Segment Backup.
	Click to adjust audio output volume
	Click to take a snapshot and save to your USB flash drive
	Tagging allows you to record information such as a person or object within the video. Click on a camera to select, pause the video when you see a person or object to be tagged, then press this button (multiple tags can be created).
	Same as above, but you can name the tag.
	Click to switch the image scale for all playing cameras between original and stretch.

- 7 – **Timeline:** Quick locate the playback position by clicking on the time line. You can zoom in or zoom out the timeline by using the timeframe options for precise location.

- 8 – Indicates the video type on the timeline.



- 9 – **Playback Status:** display the playing status.

7.1.1 - Video Segment Backup

EN

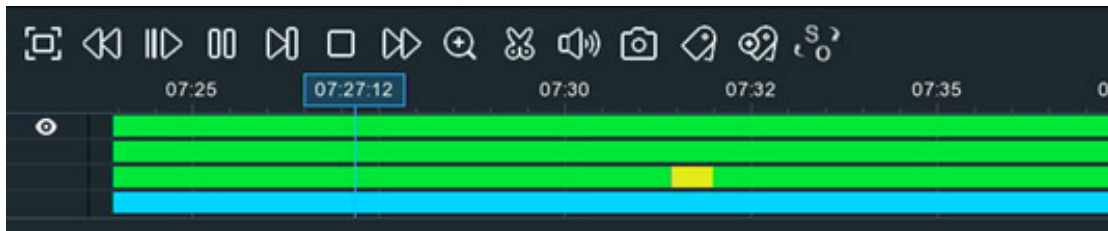

1. Insert your USB flash drive to the NVR.
2. Search & start a video recording playback.
3. Move your mouse cursor and click on the timeline where you want to cut a segment.
4. Click button. You will see two white triangles on the timeline. Move them left or right on the section of the video that you want to edit. If want to select multiplex channels, you can click on the position of the start time, and then hold and drag your mouse to select more channels, release your mouse at the position of the end time.
5. The icon is changed to icon now, click to save the video segment.
6. Select a file type for your backup files, and then click Save button to save the video segment(s). Please make sure your USB driver has enough space to save the video segment(s).
7. Choose the directory in your USB flash drive where you want to save the video segment(s), and then click OK. The progress bar at the bottom of the window shows the backup progress.

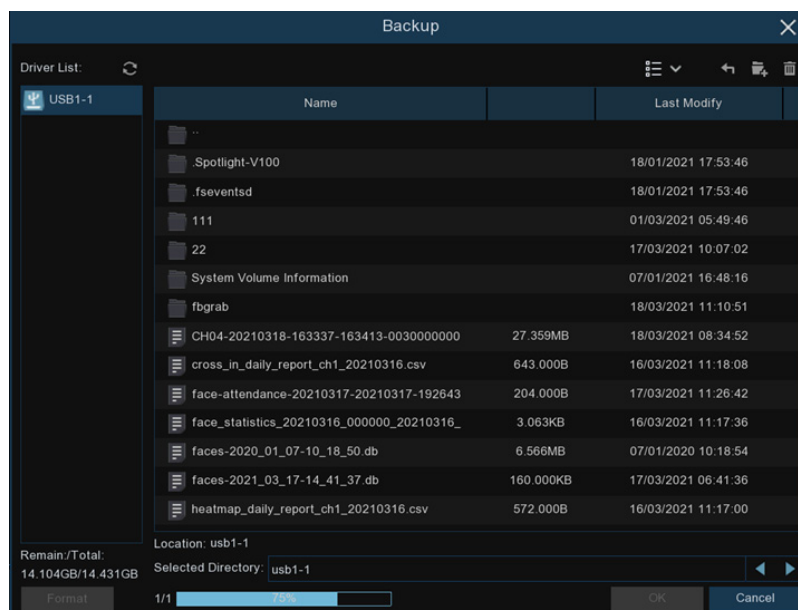
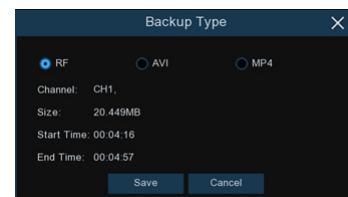
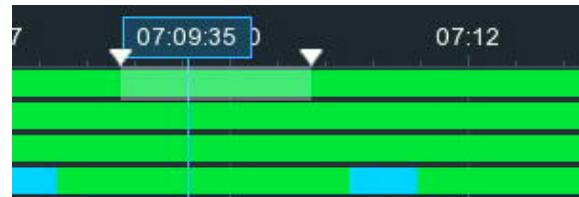

7.2 - Search, Play and Back Up Event Recordings

Event search lets you view a list of video recordings with the channel, start and end time, and recording type conveniently summarized. You can also quickly back up events to a USB flash drive.

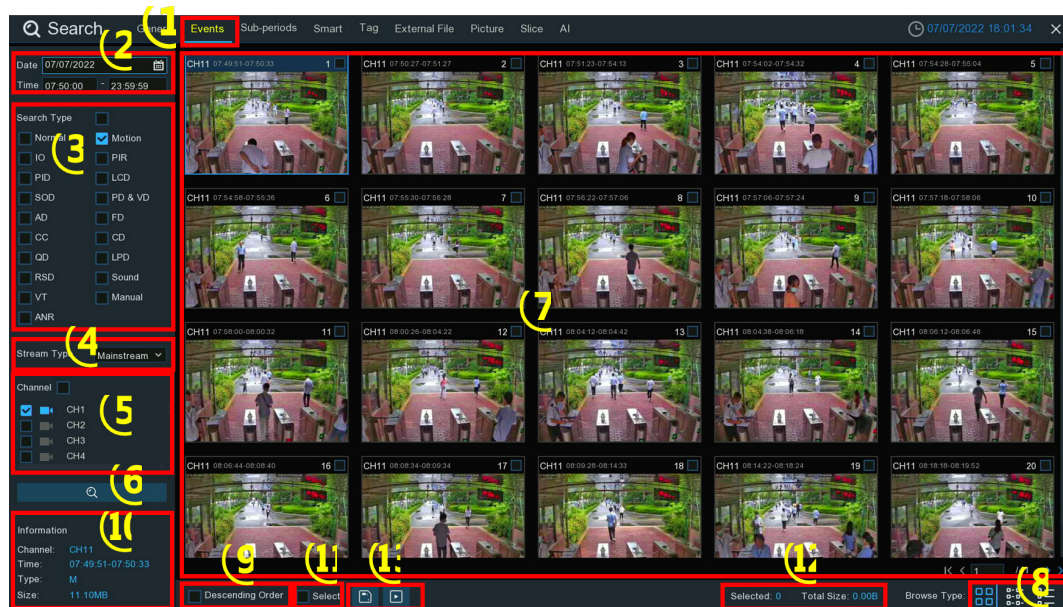

- 1 – Click the **Events** tab.
- 2 – Click the calendar icon to select a date to search on. A red underline on a date indicates recordings on those particular dates. For time, you can search over 24 hours or you can use the keypad to enter a specific start and end time.
- 3 – **Search Type:** this is the event type that you can search for. You can leave all event types enabled if you want to search for all, or select specific event types to narrow your search.
- 4 – Select the video stream to search for. Mainstream is the default option. Substream can be selected if dual-stream recording is enabled.
- 5 – Select from one or all cameras that you would like to search on. A blue camera indicates which cameras match your search criteria.
- 6 – Click Search button to commence a search.
- 7 – You will see a thumbnail of each event that matches your search criteria displayed on the result window. Use the arrow buttons to turn page or use the keypad to navigate to a specific page.
- 8 – Click these buttons to change how the events are displayed. The default view is Thumbnail but, you can change it to List or Detail. In the detailed view mode, you can lock the events to keep them from being overwritten in the hard disk drive. Click the to lock or click to unlock the events.

<input checked="" type="checkbox"/>	11	CH11	SMN	07/07/2022	07:54:02	07:54:32	7.93MB		
<input checked="" type="checkbox"/>	12	CH11	SMN	07/07/2022	07:54:28	07:55:04	9.52MB		
<input checked="" type="checkbox"/>	13	CH11	SMN	07/07/2022	07:54:58	07:55:36	10.00MB		

- 9 – Tick the checkbox to view the events in descending order.
- 10 – Click on an event thumbnail, relative information will be displayed on the left bottom corner.
- 11 – Tick the checkbox above each event thumbnail to select it, or tick the checkbox of **Select** to select all events in current page.
- 12 – The number and total size of selected event(s) will be displayed here.
- 13 – Click backup button to save all selected events to your USB flash drive directly. Or you can click play button to enter the playback window. See more on 7.2.1. Event Playback Control.

7.2.1 - Event Playback Control

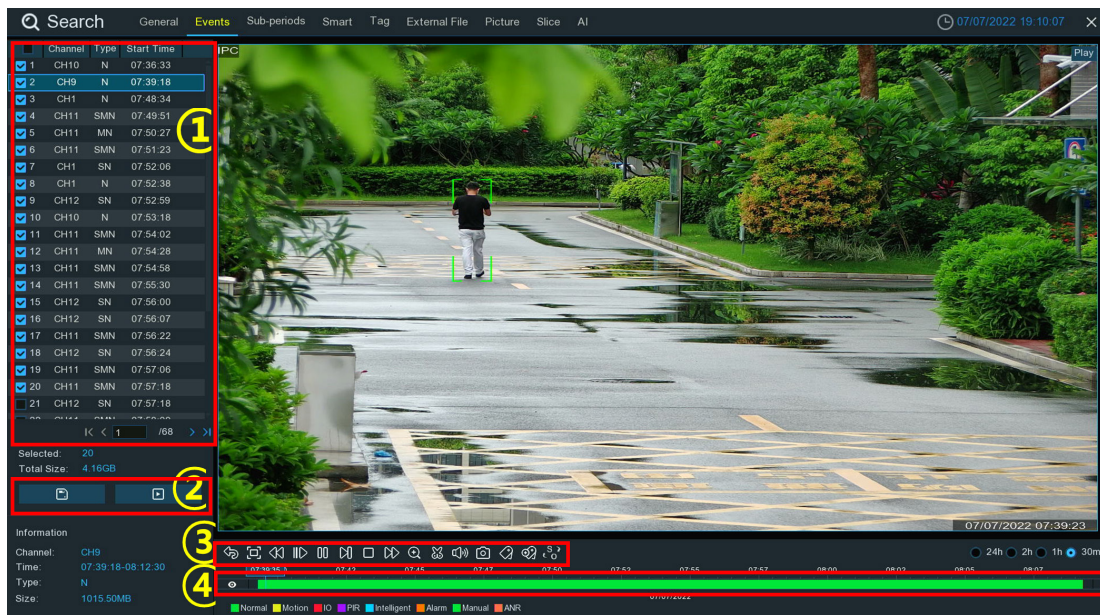

EN

- 1 – Event List, you can select the events here. Use the arrow buttons to turn page or use the keypad to navigate to a specific page. Double-click on an event to play it directly.
- 2 – Click icon to save selected events to your USB flash drive. Click button to play selected events.
- 3 – **Video Playback Controls:** to control the video playback.

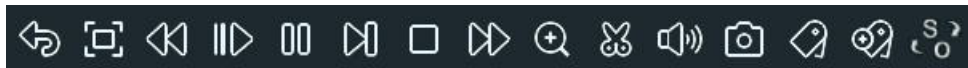

Button	Function
	Return to event search page
	Enlarge the video playback to full screen
	Rewind button, subsequent presses of the button will change the rewind speed.
	Slow Play, subsequent presses of the button will change the play speed
	Play in normal speed
	Pause
	Play frame by frame. Click once to play a frame of the video
	Stop playing
	Fast forward button, subsequent presses of the button will change the speed.
	Select a camera, click this button then use the scroll button on the mouse to zoom. Use the picture-in-picture screen to select a different area to view. Right-click to exit.
	This button allows you to edit the video by setting mark in and mark out points which you can then copy to a USB flash drive. View more on 7.1.1. Video Segment Backup.
	Click to adjust audio output volume
	Click to take a snapshot and save to your USB flash drive
	Tagging allows you to record information such as a person or object within the video. Click on a camera to select, pause the video when you see a person or object to be tagged, then press this button (multiple tags can be created).
	Same as above, but you can name the tag.
	Click to switch the image scale for all playing cameras between original and stretch.

- 4 – **Timeline:** Quick locate the playback position by clicking on the time line. You can zoom in or zoom out the timeline by using the timeframe options 24h 2h 1h 30m for precise location.















7.3 - Sub periods Playback

Sub-periods playback allows you to play multiple video segments with different time periods simultaneously from a single channel. The recordings in selected time period are divided evenly depending on the split-screen mode that has been selected. For example, if the time length of the video is an hour and Split-screens is 4, the video will be divided in to 4 segments with length of 15 minutes and played individually in each screen.



- 1 – Click the **Sub-periods** tab.
- 2 – Click the calendar icon to select a date to search on. A red underline on a date indicates recordings were taken on those particular dates. For time, you can search over 24 hours or you can use the keypad to enter a specific start and end time.
- 3 – Select a number on the Split-screens, it indicates the number that how many video segments you want the recordings to be divided evenly and played in each screen.
- 4 – Check the recording types you want to search, or tick the checkbox of **Search Type** to select all.
- 5 – Select the video stream to search for. Mainstream is the default option. Substream can be selected if dual-stream recording is enabled.
- 6 – Choose the channel you want to search. It supports to search & play one channel only at a time.
- 7 – Click the play button to start playing.



Button	Function
	Enlarge the video playback to full screen
	Rewind button, subsequent presses of the button will change the rewind speed.
	Slow Play, subsequent presses of the button will change the play speed
	Play in normal speed
	Pause
	Play frame by frame. Click once to play a frame of the video
	Stop playing
	Fast forward button, subsequent presses of the button will change the speed.
	Select a camera, click this button then use the scroll button on the mouse to zoom. Use the picture-in-picture screen to select a different area to view. Right-click to exit.
	This button allows you to edit the video by setting mark in and mark out points which you can then copy to a USB flash drive. View more on 7.1.1. Video Segment Backup.
	Click to adjust audio output volume
	Click to take a snapshot and save to your USB flash drive
	Tagging allows you to record information such as a person or object within the video. Click on a camera to select, pause the video when you see a person or object to be tagged, then press this button (multiple tags can be created).
	Same as above, but you can name the tag.
	Click to switch the image scale for all playing cameras between original and stretch.

- 8 – Click on any one of the split-screens, the time period of the video split-screen will be displayed on the timeline. The color bar on the top of the timeline indicates the time span of the video split-screen you have clicked. The color bar on the bottom of the timeline indicates the time span for the whole recordings you have searched.



7.4 - Smart Search & Playback

With Smart search function, you will be able to quickly search and play the motion events in a supported camera, no matter the motion detection is enabled in this camera or not. Especially, it allows you to define one or more specific areas of the video, to make it easier to find what you are searching for.

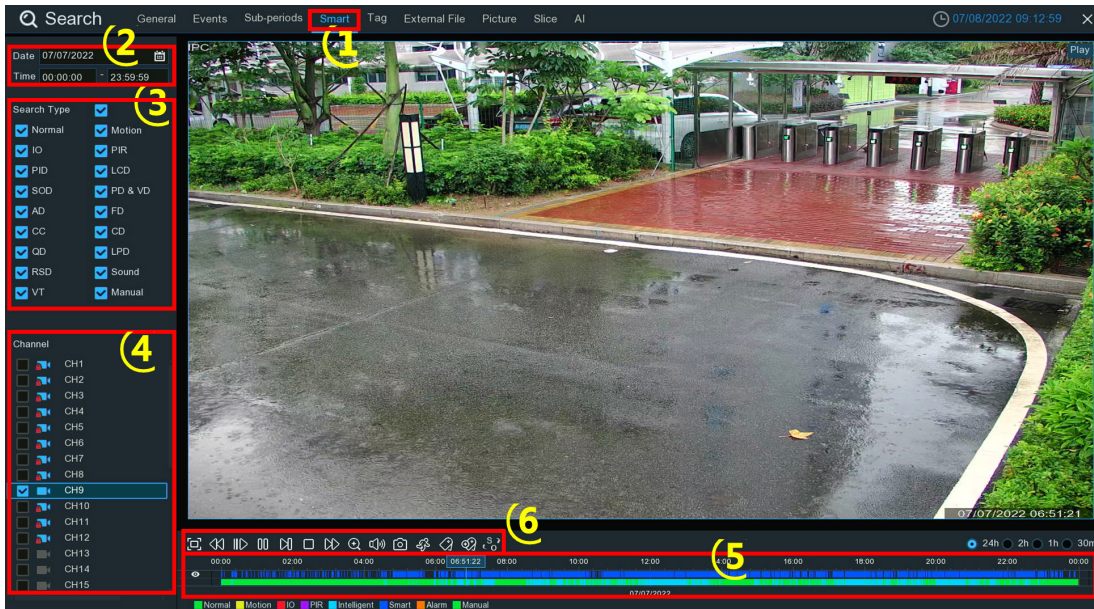

- 1 – Click the **Smart** tab.
- 2 – Click the calendar icon to select a date to search on. A red underline on a date indicates recordings were taken on those particular dates. For time, you can search over 24 hours or you can use the keypad to enter a specific start and end time.
- 3 – Check the recording types you want to search, or tick the checkbox of **Search Type** to select all.
- 4 – Choose the channel you want to search. It supports to search & play one channel only at a time.
- 5 – The Smart search result will be displayed in the time slot in dark blue color.

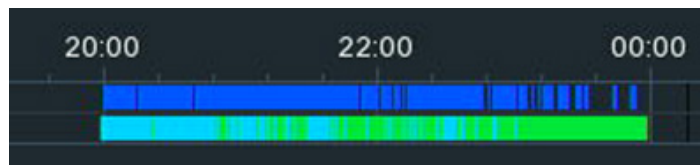

- 6 – Click the play button to start playing.



Button	Function
	Enlarge the video playback to full screen, right-click to restore.
	Rewind button, subsequent presses of the button will change the rewind speed.
	Slow Play, subsequent presses of the button will change the play speed
	Play in normal speed
	Pause
	Play frame by frame. Click once to play a frame of the video
	Stop playing
	Fast forward button, subsequent presses of the button will change the speed.
	Select a camera, click this button then use the scroll button on the mouse to zoom. Use the picture-in-picture screen to select a different area to view. Right-click to exit.
	This button allows you to edit the video by setting mark in and mark out points which you can then copy to a USB flash drive. View more on 7.1.1. Video Segment Backup.
	Click to adjust audio output volume
	Click to take a snapshot and save to your USB flash drive
	Smart Search button.
	Tagging allows you to record information such as a person or object within the video. Click on a camera to select, pause the video when you see a person or object to be tagged, then press this button (multiple tags can be created).
	Same as above, but you can name the tag.
	Click to switch the image scale for all playing cameras between original and stretch.

7 – It supports to narrow the search by define one or more specific areas of the video. Click the button on the Playback Control bar, the camera will be shown full screen, and the Smart mode controls will be visible.

- Select a full-screen detection area.
- Delete all areas created.
- Search and play video based on the areas defined.
- Return to the playback interface.

To define one or more specific areas, please do the following:

Click button to delete all aeras, and then drag to select the area that you want to define. Multiple areas can be defined.

When finished, click the Search button to search recordings based on the areas defined. You'll be returned back to the playback interface. Segments matching your search criteria will be shown on the timeline in dark blue color.



To move the controls, click and hold here, then reposition it



7.5 - Tag Search & Playback

You can search, play and manage the contents by tags that you added in live view or playback.

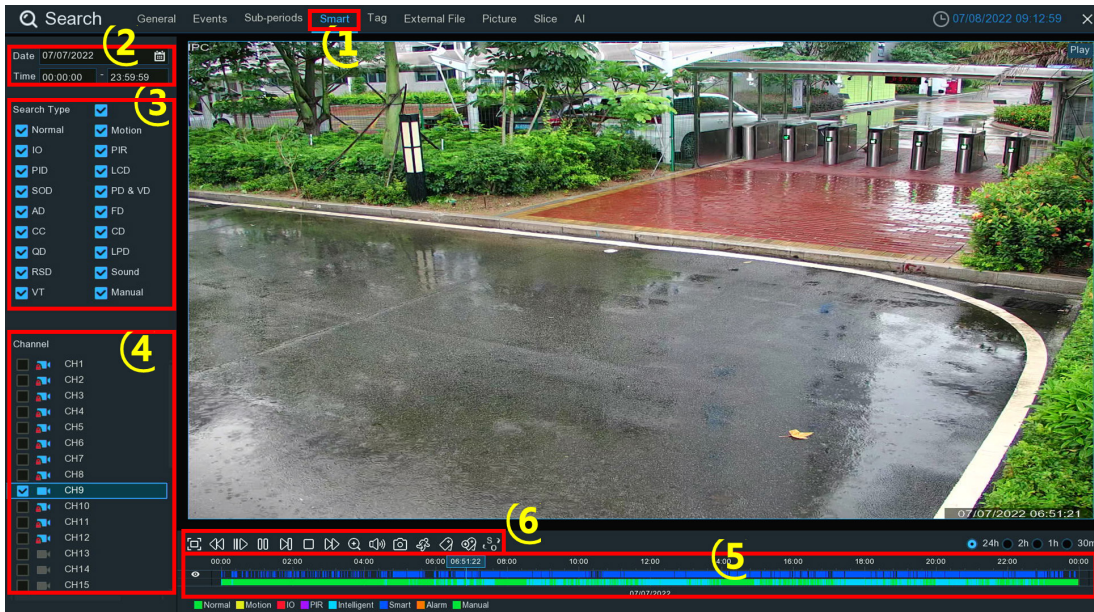

- 1 – Click the **Tag** tab.
- 2 – Click the calendar icon to select a date. A red underline on a date indicates tags were created on those particular dates. For time, you can use the keypad to enter a specific start and end time.
- 3 – If you have created one or more customized tags, click this to input the tag name (tag names are case sensitive).
- 4 – Select the channel(s) you want to search.
- 5 – Click **Q** button to search.
- 6 – Tags matching your search criteria will be displayed on the right window.
- 7 – Click the play button **▶** to start playing.



Adjust the time to view more recordings before or after the event.

- 8 – If you want to modify the tag name, click **✎** button. Click **🗑** button to delete the tag.

7.6 - Play External File

The NVR supports to play the videos that you have copied to a USB flash drive.

EN



- 1 – Click the **External File** tab.
- 2 – If multiple USB flash drives are connected, click the drop-down menu to select the drive that you want to read from.
- 3 – Select the file type you want to search and play. Leave default to search all supported formats.
- 4 – Select the directory folder where the video files are saved. Double-click an event to play.
- 5 – If you want to refresh the USB flash drive, click this button.
- 6 – Play control buttons:

Button	Function
	Enlarge the video playback to full screen, right-click to restore.
	Slow Play, subsequent presses of the button will change the play speed
	Play in normal speed
	Pause
	Play frame by frame. Click once to play a frame of the video
	Stop playing
	Fast forward button, subsequent presses of the button will change the speed.
	Click to adjust audio output volume

7.7 - Search & Video Snapshots

This function can be used to search, view and copy snapshots to a USB flash drive.

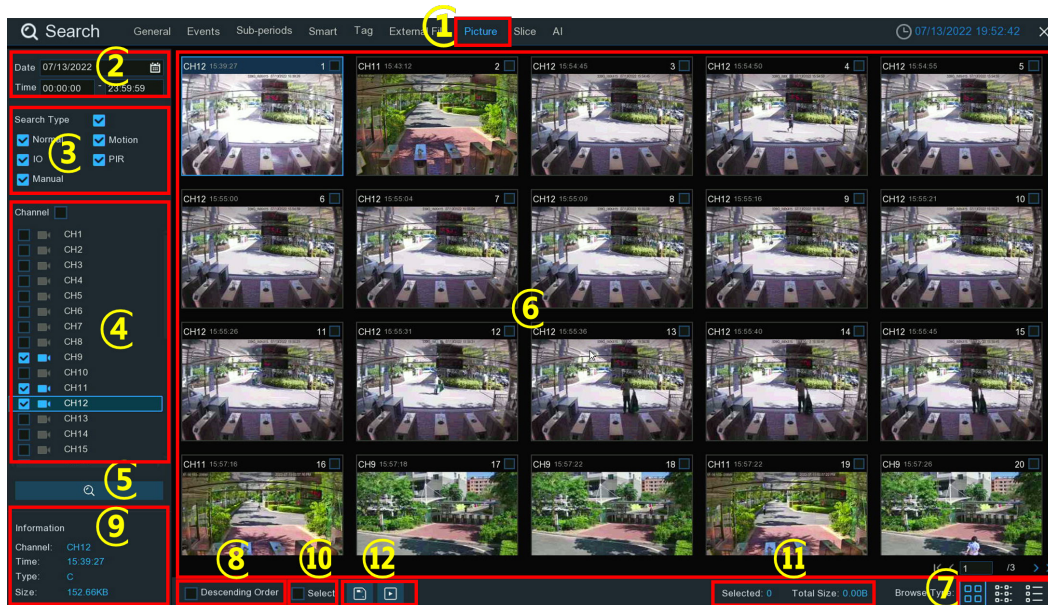

- 1 – Click the **Picture** tab.
- 2 – Click the calendar icon to select a date to search on. A red underline on a date indicates snapshots were taken on those particular dates. For time, you can search over 24 hours or you can use the keypad to enter a specific start and end time.
- 3 – **Search Type:** this is the event type that you can search for. You can leave all event types enabled if you want to search for all, or select specific event types to narrow your search.
- 4 – Select from one or more cameras that you would like to search on. A blue camera indicates which cameras match your search criteria.
- 5 – Click Search button to commence a search.
- 6 – You will see a thumbnail of each snapshot that matches your search criteria displayed on the result window. Use the arrow buttons to turn page or use the keypad to navigate to a specific page.
- 7 – Click these buttons to change how the snapshots are displayed. The default view is Thumbnail but, you can change it to List or Detail.
- 8 – Tick the checkbox to view the snapshots in descending order.
- 9 – Click on a thumbnail, relative information will be displayed on the left bottom corner.
- 10 – Tick the checkbox above each snapshot thumbnail to select it, or tick the checkbox of **Select** to select all snapshots in current page.
- 11 – The number and total size of selected snapshot(s) will be displayed here.
- 12 – Click backup button to copy all selected snapshots to your USB flash drive directly. You can click play button to enter the slideshow window. See more on 7.7.1. Playing Slideshow.

7.7.1 - Playing Slideshow

The selected snapshots will be played in a slideshow.

EN

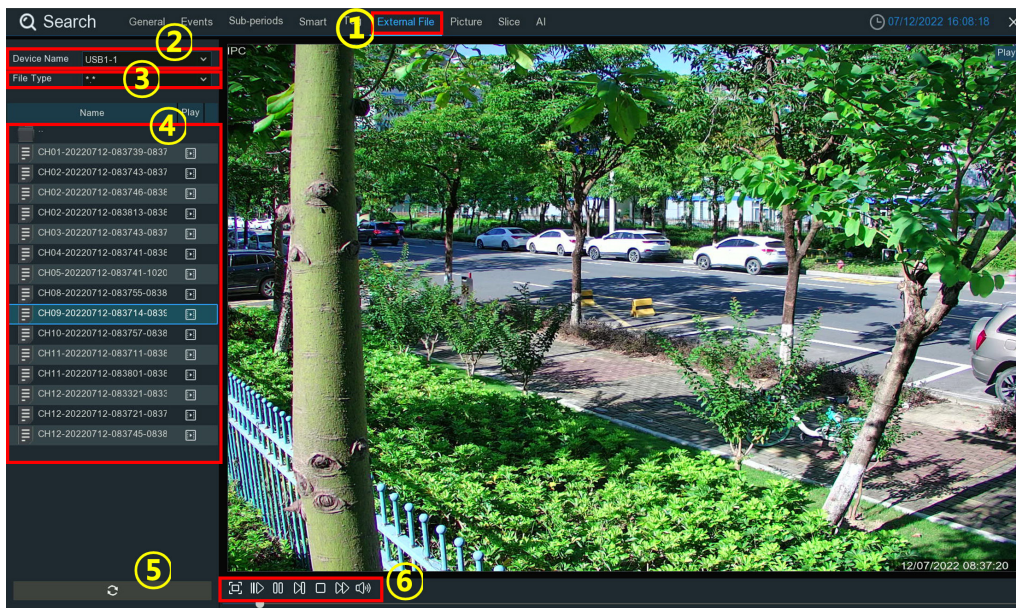

1 – Play control buttons:

Button	Function
	Click to pause slideshow.
	When the slideshow is paused, you can click this button to view previous snapshot.
	Click to play slideshow.
	When the slideshow is paused, you can click this button to view next snapshot.

- 2 – To select how many snapshots that you want to view at once in the screen.
- 3 – Selected snapshots will be displayed here. Use the arrow buttons to turn page or use the keypad to navigate to a specific page.
- 4 – Select a snapshot, then click this button to copy it to a USB flash drive.
- 5 – To display snapshot information.
- 6 – Click this to go back to the previous screen.

7.8 - Slice Search

This function is able to slice the recordings into each one minute, which helps to quickly search what you want to see.

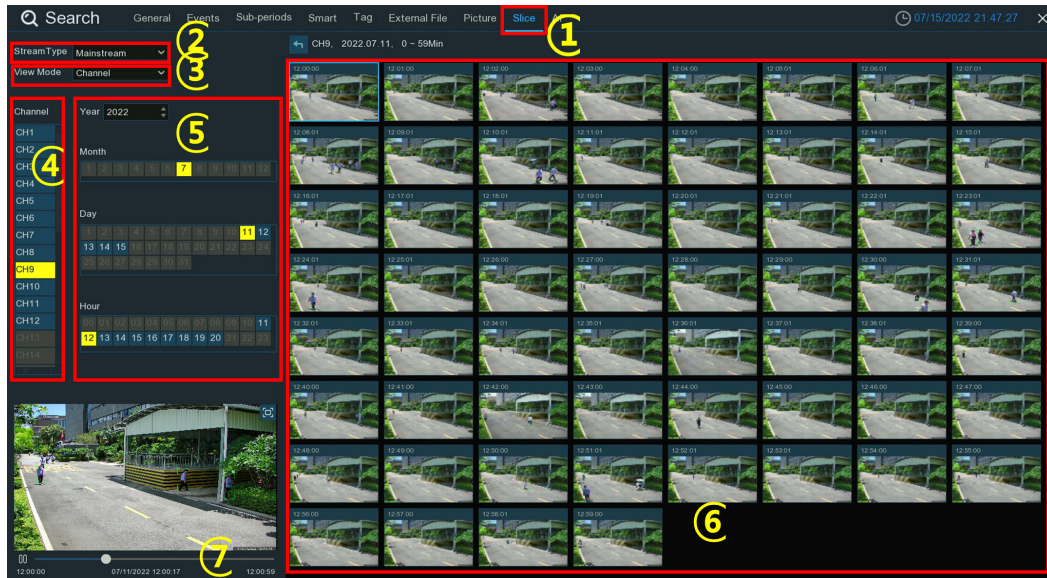

- 1 – Click the **Slice** tab.
- 2 – Select the video stream to search for. Mainstream is the default option. Substream can be selected if dual-stream recording is enabled.
- 3 – Select the View Mode:
 - **Channel:** Your search will focus primarily on what happen in different time period in the selected camera.
 - **Time:** Your search will focus primarily on what happened in different cameras in a certain time period.
- 4 – To choose the channel you want to search for. Only one channel allowed to search at once.
- 5 – To choose the time (by hour) you want to search for.
- 6 – When the channel and hour has been selected, the available one-hour recordings will be sliced into 60 segments from the first minute to the last of the hour, and the thumbnail images of each minute will be displayed on the screen.
- 7 – Click on any one of the thumbnail images, the video will be played on the left bottom corner. Click on the time bar to adjust the play position. Click button, you can view the playback on full screen and make a backup.

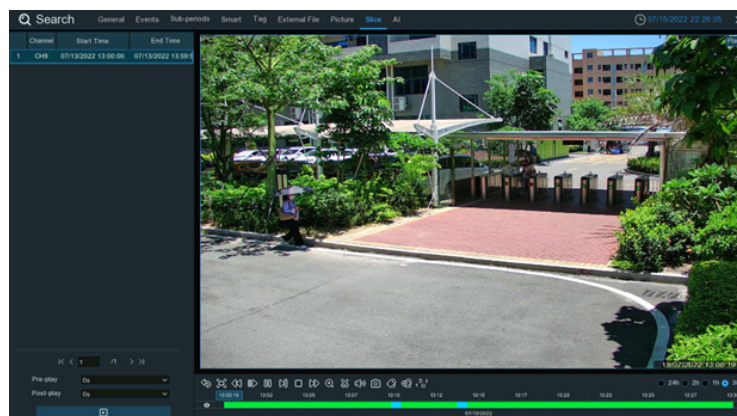

7.9 - AI Search

In the AI search section, you'll be able to search events of face detection, license plates, human & vehicle detection, PID & LCD, repeat visitors and face attendance.

EN

7.9.1 - Face Detection Events

Click **Face** tab to enter the face search section, if you have enabled the face detection in camera(s), you will see the face images captured by all cameras on current day.



- 1 – You can change the search time. Click the calendar icon to select a date to search on. A red underline on a date indicates face images were taken on those particular dates. For time, you can use the keypad to enter a specific start and end time.
- 2 – The system searches all channels by default. You can click the **Channels** button to select specific channel(s) that you want to search for.
- 3 – Click **Search** button to commence a search.
- 4 – Use the arrow buttons to turn page or use the keypad to navigate to a specific page.
- 5 – Click these buttons to change how the events are displayed. The default view is Thumbnail, but you can change it to List or Detail.
- 6 – You can change to display the images in ascending or descending order by time.
- 7 – You can narrow your search by selecting specific alarm group(s).
- 8 – Tick the checkbox above each image to select it, or tick the checkbox of **Select** to select all images in current page.

- 9 – Click backup button to copy all selected face images to your USB flash drive. If you want to save video files also, tick the checkbox of **Record**, and then select the video format, adjust the length of time before and after the events.

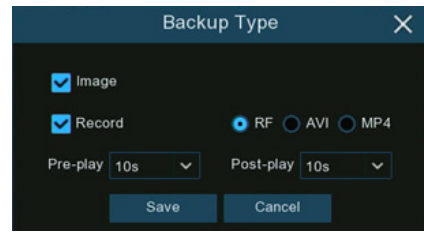

You can click play button to play the selected events, or click to add time duration before and after the event and then play. See more on 7.9.1.1. Playing Events.

7.9.1.1 - Playing Events

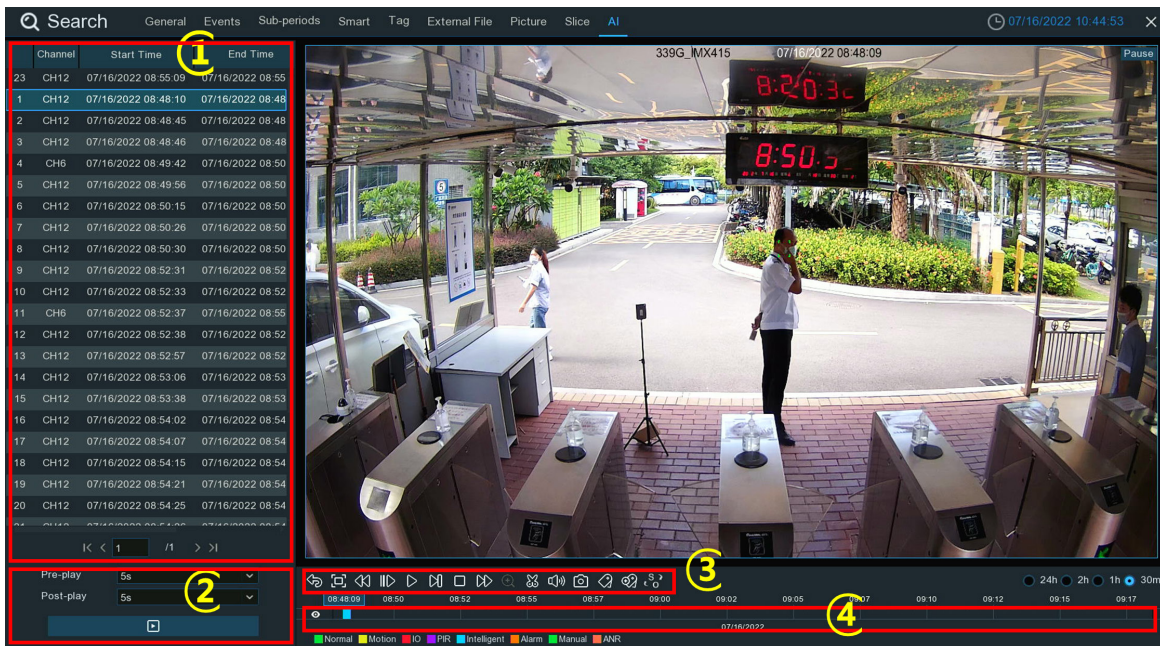

- 1 – Event List. Use the arrow buttons to turn page or use the keypad to navigate to a specific page. Double-click on an event to play it directly.
- 2 – You can add time duration before and after the event and then click button to play.
- 3 – Video Playback Controls: to control the video playback

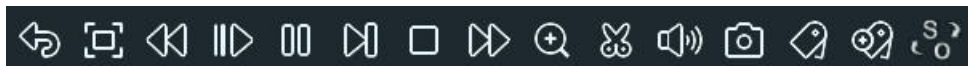

Button	Function
	Return to event search page
	Enlarge the video playback to full screen
	Rewind button, subsequent presses of the button will change the rewind speed.
	Slow Play, subsequent presses of the button will change the play speed
	Play in normal speed
	Pause
	Play frame by frame. Click once to play a frame of the video
	Stop playing
	Fast forward button, subsequent presses of the button will change the speed.
	Select a camera, click this button then use the scroll button on the mouse to zoom. Use the picture-in-picture screen to select a different area to view. Right-click to exit.
	This button allows you to edit the video by setting mark in and mark out points which you can then copy to a USB flash drive. View more on 7.1.1. Video Segment Backup.
	Click to adjust audio output volume
	Click to take a snapshot and save to your USB flash drive
	Tagging allows you to record information such as a person or object within the video. Click on a camera to select, pause the video when you see a person or object to be tagged, then press this button (multiple tags can be created).
	Same as above, but you can name the tag.
	Click to switch the image scale for all playing cameras between original and stretch.

4 – **Timeline:** Quick locate the playback position by clicking on the time line. You can zoom in or zoom out the timeline by using the timeframe options for precise location.

7.9.1.2 - Search & Compare Face Images (Recognition)

You can appoint one or more face profiles selected from face recognition data base and then search, the system will compare and display the face images that match your search criteria.

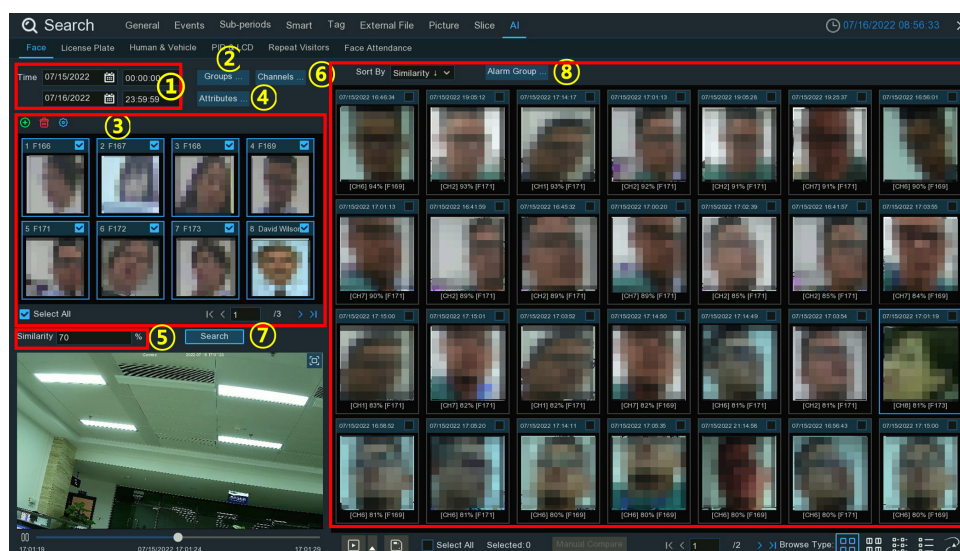

- 1 – Click the calendar icon to select a date to search on. A red underline on a date indicates snapshots were taken on those particular dates. For time, you can search over 24 hours or you can use the keypad to enter a specific start and end time.
- 2 – Click Groups button, and then select the groups where your targeted face profiles are saved in.
- 3 – All face profiles exist in your selected group(s) will be displayed in the display window:

All face profiles are selected by default. You can untick the checkbox of "Select All" to deselect all.

Tick or untick the checkbox above each image to select or deselect it.

If you want to delete a face profile, click on the image, and then click the button .

If you want to add more targeted face images, click add button , and then select face images from internal or external storage device.

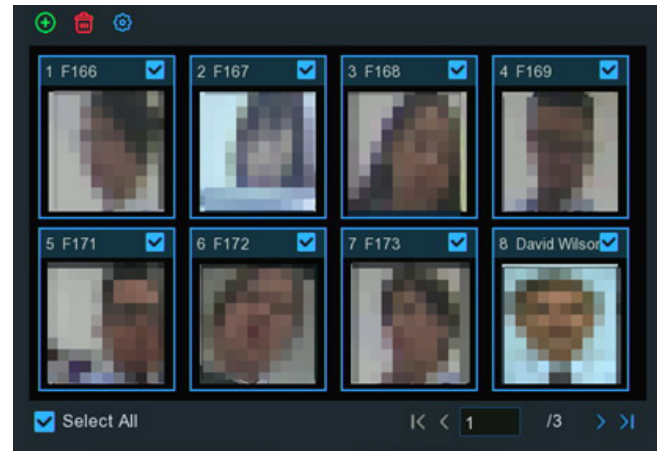

- 4 – If you have enabled the Face Attributes detection (5.4.1.1. FD), you can click here to appoint the attribute(s) you want to search.
- 5 – Set the Similarity: Set how closely, in percentage terms, the detected face must match a targeted face to be considered a recognized match. The default threshold is 70%. A higher similarity % will result in fewer false recognition results.
- 6 – The system searches all channels by default. You can click the **Channels** button to select specific channel(s) that you want to search for.
- 7 – Click **Search** button to commence a search.
- 8 – The face images that match your search criteria will be displayed. You can narrow your search by selecting specific alarm group(s).

7.9.1.3 - Tracking Face

You can load a map and replace your cameras on the map. With the tracking function, you can easily to see someone's appearance/ disappearance time & position in your appointed cameras, and his/her movement track during the selected time period.

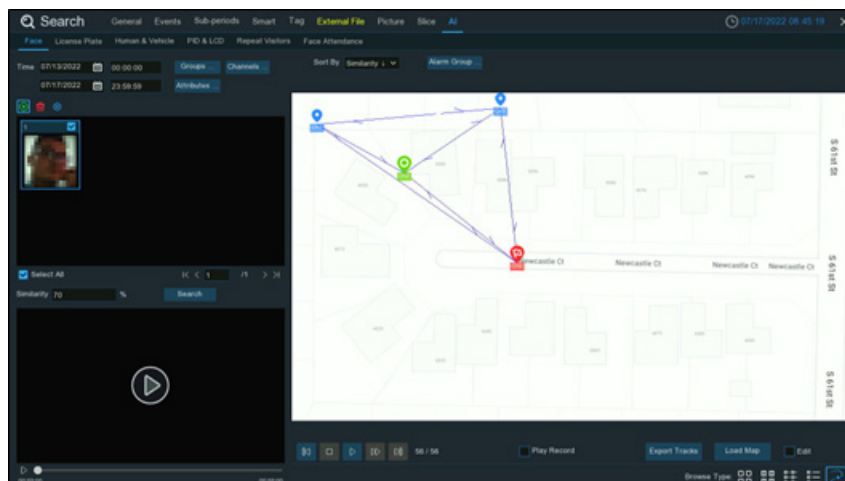

- 1 – On the Face search page, click the tracking button to enter the operation page.

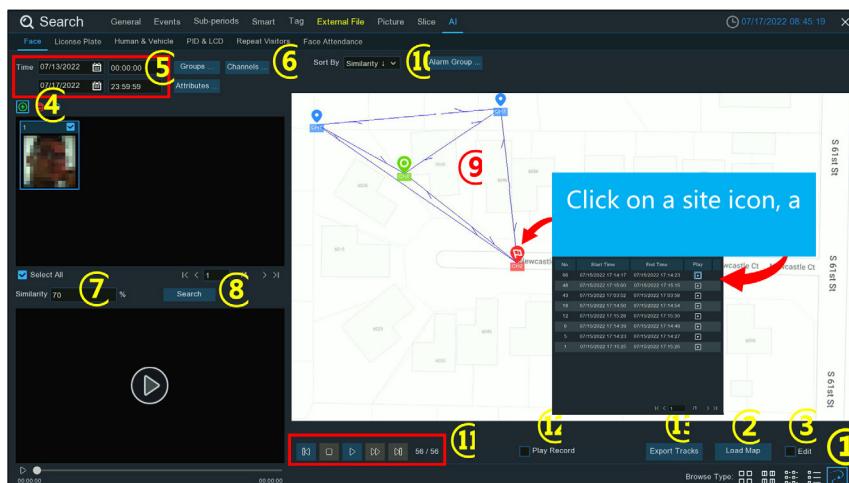

EN

- 2 – Click **Load Map** button to load a map image from your USB flash drive.
- 3 – Tick the checkbox of **Edit**, you will see site icons which are equal with the number of your NVR channels. You can move the cameras to the positions where you want them to be placed on the map.



- 4 – Click add button , and then select a face image from internal or external storage device.

i NOTE: The system supports to track only one face each time.

- 5 – Click the calendar icon to select a date to search on. A red underline on a date indicates snapshots were taken on those particular dates. For time, you can search over 24 hours or you can use the keypad to enter a specific start and end time.
- 6 – The system searches all channels by default. You can click the "Channels" button to select specific channel(s) that you want to search for.
- 7 – Set the Similarity: Set how closely, in percentage terms, the detected face must match a targeted face to be considered a recognized match. The default threshold is 70%. A higher similarity % will result in fewer false recognition results.
- 8 – Click Search button to commence a search.
- 9 – After a while, several camera site icons are displayed on the map with different colors and illustrations. It displays when and where the person appeared at the first time, and when and where the person was last detected by a camera.



- First Detected Point
- Last Detected Point
- First & Last Detected Point
- Waypoint

- 10 – Click to choose **Time** ↑ to sort the events from oldest to newest.
- 11 – Click button to start playing an animation demonstration of the person's movement track. You can control the playing with below buttons:



	Click to display previous movement
	Stop
	Play
	Pause
	Click to adjust the play speed
	Click to display next movement

- 12 – If you tick the checkbox of **Play Record**, the animation of movement track will be played together with the event recording.
- 13 – Export the tracking data for the selected time period to a USB flash drive. The file will be saved as an excel file. You can open the file in Excel (or similar software) to further analyze the data.

7.9.2 - Search License Plate

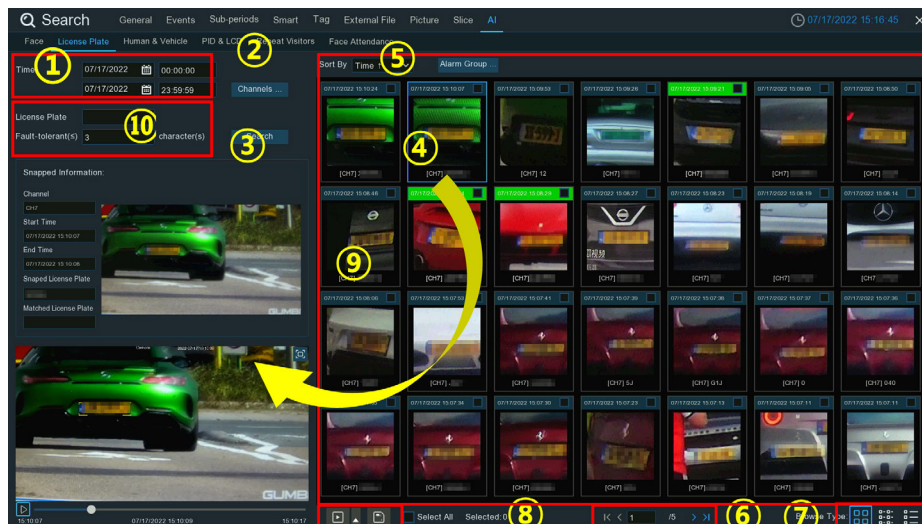
Click **License Plate** tab to enter the license search section, if you have enabled the license plate detection in camera(s), you will see the license detection events captured on current day.



- 1 – Click the calendar icon to select a date to search on. A red underline on a date indicates license plates were taken on those particular dates. For time, you can use the keypad to enter a specific start and end time.
- 2 – The system searches all channels by default. You can click the **Channels** button to select specific channel(s) that you want to search for.
- 3 – Click **Search** button to commence a search.
- 4 – The search result will be displayed on the right side of the screen.
- 5 – You can change to display the images in ascending or descending order by time.
- 6 – Use the arrow buttons to turn page or use the keypad to navigate to a specific page.
- 7 – Click these buttons to change how the events are displayed. The default view is Thumbnail, but you can change it to List or Detail.
- 8 – Tick the checkbox above each event to select it, or tick the checkbox of **Select** to select all events in current page.
- 9 – Click backup button  to copy all selected face images to your USB flash drive. If you want to save video files also, tick the checkbox of **Record**, and then select the video format, adjust the length of time before and after the events.
You can click play button  to play the selected events, or click  to add time duration before and after the event and then play. See more on 7.9.1.1. Playing Events.
- 10 – You can input the license number and set the number of **Fault Tolerance** to narrow your search.
Fault Tolerance: Varies in image resolution, light strength, camera angles, moving speed of the vehicle and etc., character(s) in the license plate number might be failed to recognize. Set the Fault Tolerance that how many characters the detected license allowed to be different from the license number saved in the group. If the number of difference characters between the detected license number and a license profile in the group is no more than the set value, the detected license will be considered a recognized match.

Recognized License Numbers	Input Numbers	Fault Tolerance	Recognition Results
AB123C	AB-123-C	≤2 characters	True
AB123C	AB-123-C	≤0 or 1 character	False
A8I23C	AB123C	≤2 characters	True
A8I23C	AB123C	≤0 or 1 character	False
B594SB	B734KB	≤3 characters	True
B594SB	B734KB	≤2 character	False
AB132C	AB123C	≤2 characters	True
AB123C	AB123C	≤1 or 1 character	True

 **NOTE:** Only English letters and digit numbers will be recognized by the system, special symbols, like underline , virgule /, hyphen -, will be excluded from being recognized. Please set the Fault Tolerance accordingly if you have input special symbols in the license number when creating a license profile.

7.9.3 - Human & Vehicle

Click **Human & Vehicle** tab to enter the human & vehicle search section, if you have enabled the human & vehicle detection in camera(s), you will see the human & vehicle detection events captured on current day.

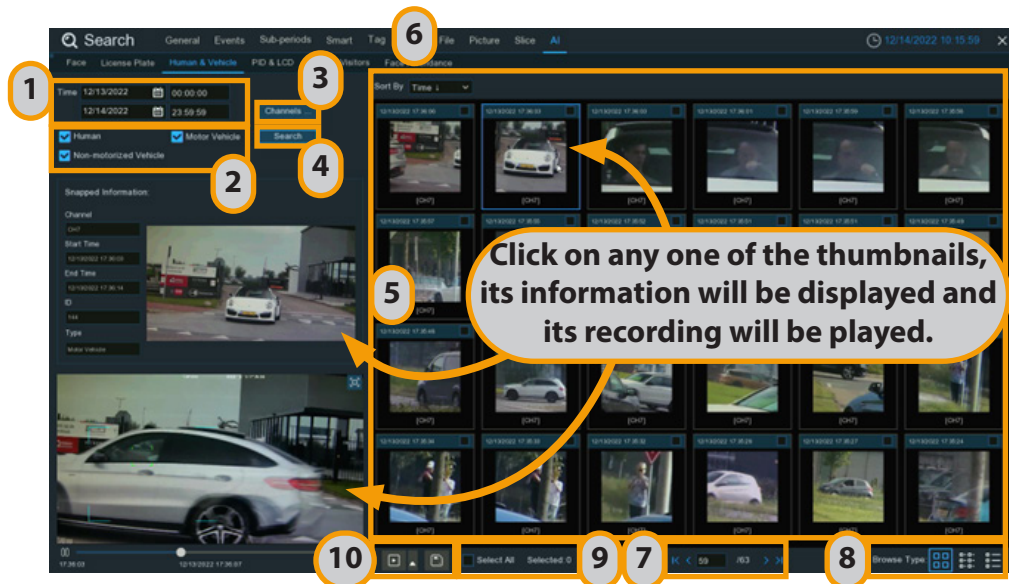

- 1 – Click the calendar icon to select a date to search on. A red underline on a date indicates human and/or vehicles were taken on those particular dates. For time, you can use the keypad to enter a specific start and end time.
- 2 – Select the target type(s) you want to search for.
- 3 – The system searches all channels by default. You can click the **Channels** button select specific channel(s) that you want to search for.
- 4 – Click Search button to commence a search.
- 5 – The search result will be displayed on the right side of the screen.
- 6 – You can change to display the images in ascending or descending order by time.
- 7 – Use the arrow buttons to turn page or use the keypad to navigate to a specific page.
- 8 – Click these buttons to change how the events are displayed. The default view is Thumbnail, but you can change it to List or Detail.
- 9 – Tick the checkbox above each event to select it, or tick the checkbox of **Select** to select all events in current page.
- 10 – Click backup button to copy all selected face images to your USB flash drive. If you want to save video files also, tick the checkbox of **Record**, and then select the video format, adjust the length of time before and after the events.

You can click play button to play the selected events, or click to add time duration before and after the event and then play. See more on 7.9.1.1. Playing Events.

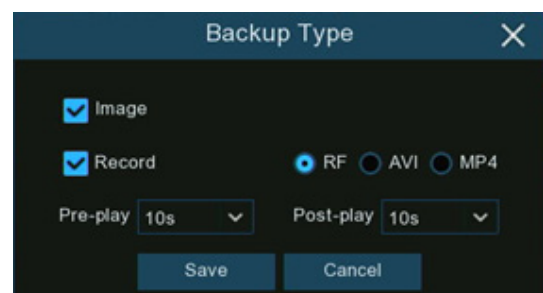

7.9.4 - PID & LCD

Click **PID & LCD** tab to enter the PID (Perimeter Intrusion Detection) & LCD (Line Crossing Detection) event search section, if you have enabled the PID and/or LCD in camera(s), you will see the detection events captured on current day.

EN

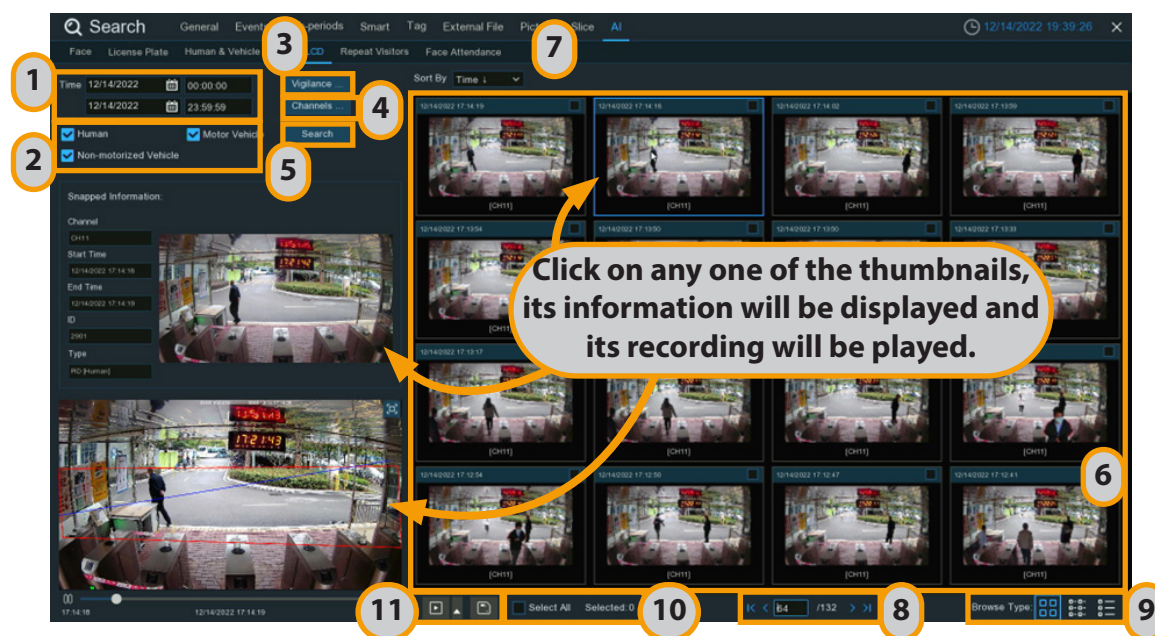

- 1 – Click the calendar icon to select a date to search on. A red underline on a date indicates human and/or vehicles were taken on those particular dates. For time, you can use the keypad to enter a specific start and end time.
- 2 – Select the target type(s) you want to search for.
- 3 – Select PID and/or LCD in Vigilance.
- 4 – The system searches all channels by default. You can click the **Channels** button to select specific channel(s) that you want to search for.
- 5 – Click **Search** button to commence a search.
- 6 – The search result will be displayed on the right side of the screen.
- 7 – You can change to display the images in ascending or descending order by time.
- 8 – Use the arrow buttons to turn page or use the keypad to navigate to a specific page.
- 9 – Click these buttons to change how the events are displayed. The default view is Thumbnail, but you can change it to List or Detail.
- 10 – Tick the checkbox above each event to select it, or tick the checkbox of **Select** to select all events in current page.
- 11 – Click backup button to copy all selected face images to your USB flash drive. If you want to save video files also, tick the checkbox of **Record**, and then select the video format, adjust the length of time before and after the events.

You can click play button to play the selected events, or click to add time duration before and after the event and then play. See more on 7.9.1.1. Playing Events.

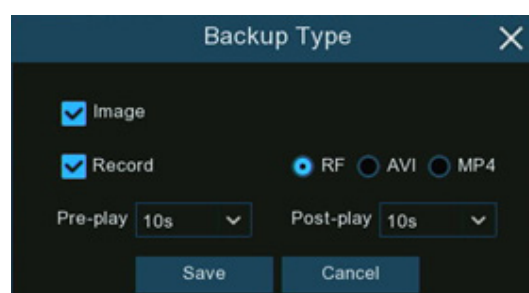

7.9.5 - Repeat Visitors

This is a function to fast search the frequency of occurrence of persons in a certain time period.

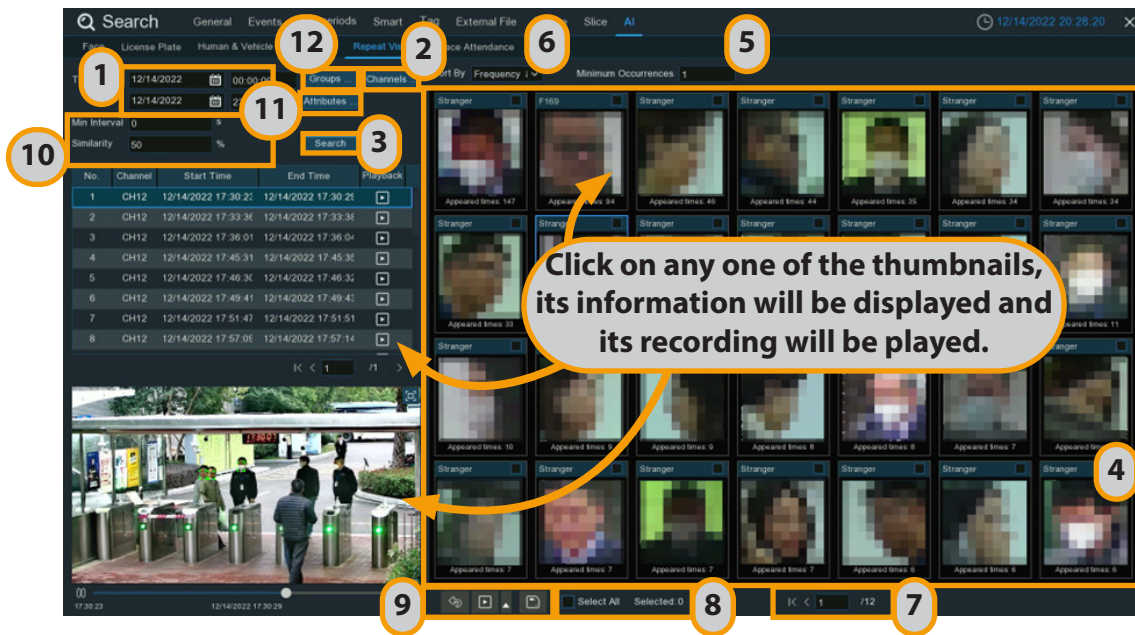

- 1 – Click the calendar icon to select a date to search on. A red underline on a date indicates human and/or vehicles were taken on those particular dates. For time, you can use the keypad to enter a specific start and end time.
- 2 – The system searches all channels by default. You can click the **Channels** button to select specific channel(s) that you want to search for.
- 3 – Click **Search** button to commence a search.
- 4 – The search result will be displayed on the right side of the screen. **Appeared Times** under each thumbnail image indicates how many times the person was captured during your search period.
- 5 – You can input a number of **Minimum Occurrences** to hide the search result whose appeared time is less than the number of minimum occurrences.
- 6 – You can change to display the images in ascending or descending order by time or frequency.
- 7 – Use the arrow buttons to turn page or use the keypad to navigate to a specific page.
- 8 – Tick the checkbox above each event to select it, or tick the checkbox of **Select** to select all events in current page.
- 9 – Click backup button to copy all selected face images to your USB flash drive. If you want to save video files also, tick the checkbox of **Record**, and then select the video format, adjust the length of time before and after the events.

You can click play button to play the selected events, or click to add time duration before and after the event and then play. See more on 7.9.1.1. Playing Events.

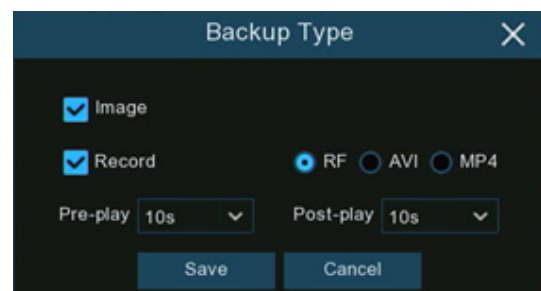

- 10 – You can narrow your search by adjusting the **Min. Interval** time and the percentage of **Similarity**.

Min. Interval is used to reduce the quantity of searched face images that repeatedly captured within a short period time. For example, if the Min. Interval is set to 20 seconds, then starting from the time of the first face image searched on the selected date, all the similar face images that appear within 20 seconds will only display the first image. The system will display the first image captured in every 20 seconds.

Similarity is used to set how closely, in percentage terms, the searched faces must match each other to be considered a recognized same person. A higher percentage of similarity will result in fewer false recognition results.

- 11 – Furthermore, you can select the face features to execute refined search. Click **Attributes** button, and then select the features you want to search for, and then click **Search** button again.

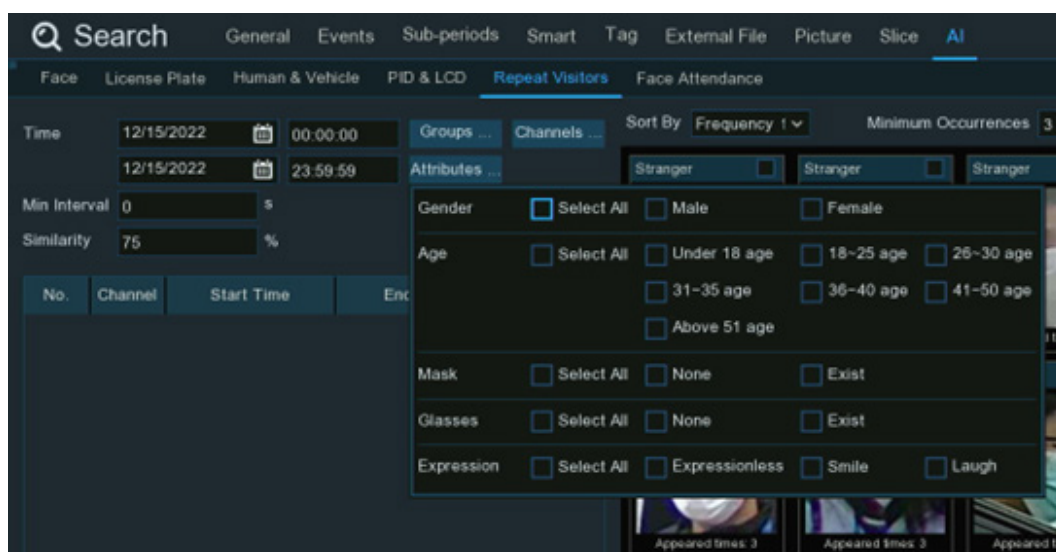



- 12 – By default, the system will search and display all captured face images during your searching time period. If you want to search for the persons whose face profiles had been stored in the groups, click the Group button and choose the face group(s) accordingly.

7.9.6 - Face Attendance

Face Attendance is used to assist in attendance checking by faces. It will help to analyze the absenteeism, coming late and leaving early.

NOTE: In case of failure, do NOT take the face attendance function as your only measure to check attendance.

- 1 – Select the channel(s).
- 2 – Select search by Group or by Person. If you choose **By Group**, all the persons in the selected group(s) will be searched. If you choose **By Person**, only your selected person(s) will be searched. Click the filter icon  to choose group(s) or person(s). Your selected person(s) will be displayed on the left middle side of the window.
- 3 – Select the search date by an individual day, week, month, current day or customized date.
- 4 – Set the Working Days.
- 5 – Set the On Duty Time and Off Duty Time.
- 6 – Click **Search** button, the result will be displayed on the right side of the window.
- 7 – You can export the data to your USB flash drive or send by email.
- 8 – Click on the detail icon , you will see the captured images and videos of the first occurrence and the last occurrence of the person in the day. Click on the play button  to have a quick playback.

7.10 - Exported Video File

The exported video File(s) will be optionally password protected and contain checksums to detect file manipulation.

EN

When searching the video file you want to download, Insert the USB disk into the device and click <  > to download the video file, the prompt “Does the video file need to be encrypted” appears in the screen.

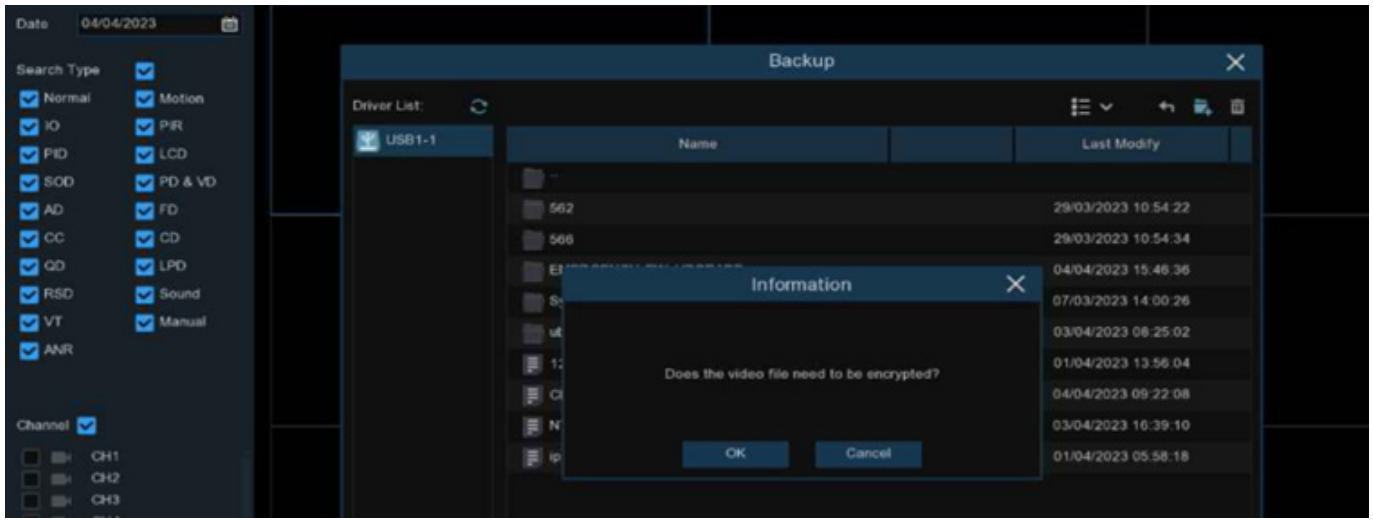

1. Click <ok> to enter into the following menu and set the video's password
2. Click <ok> to start the backup

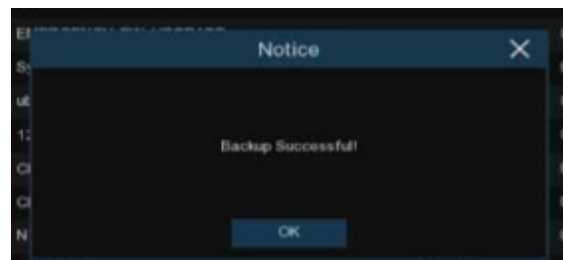
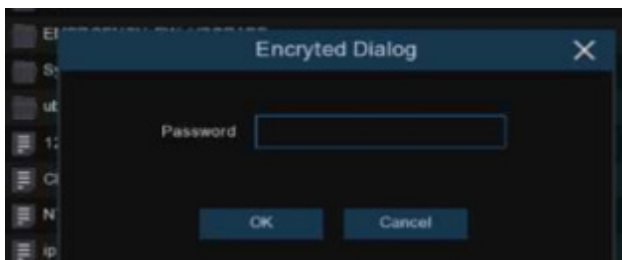

8 - REMOTE ACCESS THROUGH THE WEB CLIENT

You can use the web client on a PC to access the device remotely at any time. Before using the web client, you need to ensure that the device network is normal.

8.1 - Basic System Environment Requirements

The minimum requirements for the hardware and operating system for running the web client are as follows.

Item	Minimum Value	Recommended Value
CPU	Intel® Core™ i5 CPU	Intel® Core™ i5 CPU or higher
RAM	≥ 4 GB	≥ 8 GB
Hard disk drive	≥ 500 GB	≥ 1000 GB
Video memory	≥ 2 GB	≥ 4 GB
Display resolution	1280*1024	1920*1080
OS	Windows 7 or above Mac OS X®10.9 or above	
DirectX	DirectX 11	
Direct3D	Acceleration Function	
Ethernet adapter	10/100/1000 M Ethernet adapter	
Internet Explorer (IE) web browser	Microsoft Internet Explorer (version: V11, V10)	
Firefox web browser	V52 or above	
Google Chrome web browser	V57 or above	
Apple Safari web browser	V12.1 or above	
Edge web browser	V79 or above (using the Chromium core)	

8.2 - Web Plug in Downloading and Installation

To access the Web client, perform the following steps:

1. Open the web browser, enter the IP address or "DDNS + port number" of the device in the URL bar to open the user information verification page. Then, enter the correct user name and password to log in to the web client. (If you enter an incorrect password for consecutive five times, your account will be locked for 180 s.)

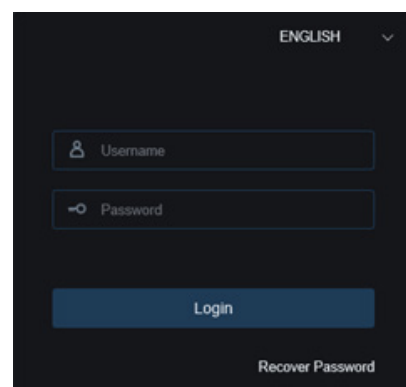

- When you access the web client through the IE for the first time, the system requires you to install a plug-in. Click Download and install the player to download the plug-in and install it on the computer.

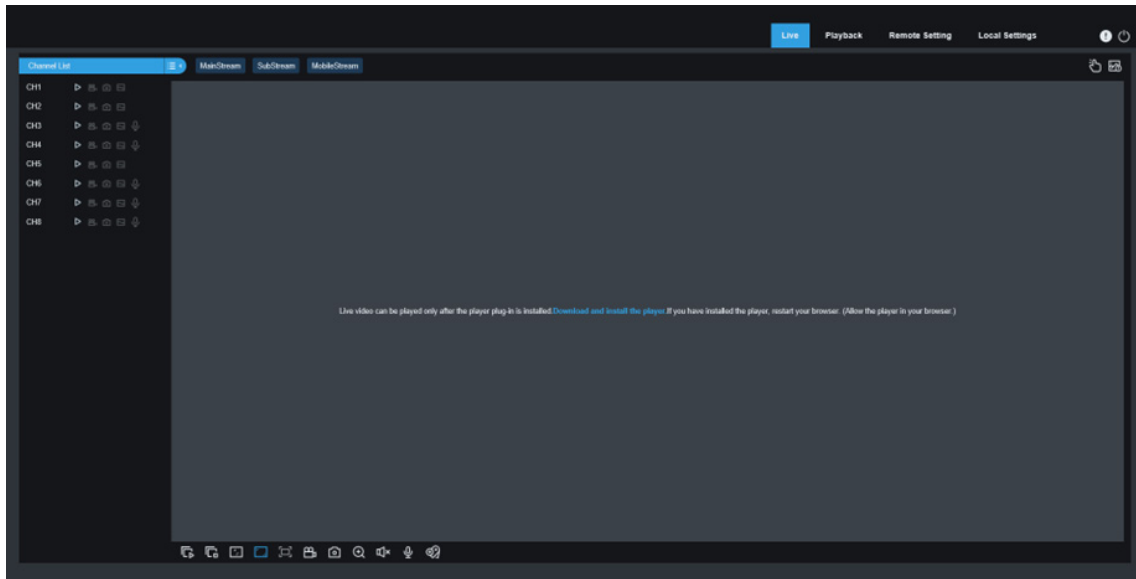

- After installing the plug-in, refresh the page, and click Allow in the pop-up dialog box at the bottom of the page. Then, images can be displayed properly.

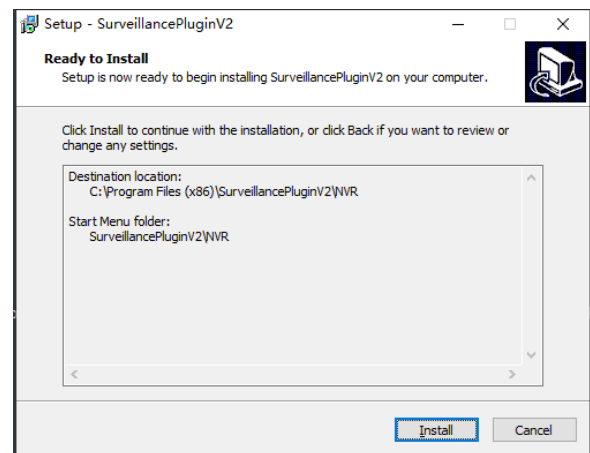

i NOTE: If you use the Apple Safari, Google Chrome, Firefox, or Microsoft Edge web browser, you do not need to download the plug-in and can directly log in to the device.

8.3 - Web Client Management

8.3.1 - Live View Page

After user information is verified on the web client, the live view page of the device is displayed, on which you can enable or disable the live view, manually record video to the local computer, and perform screen snapshot, PTZ control, and color adjustment.

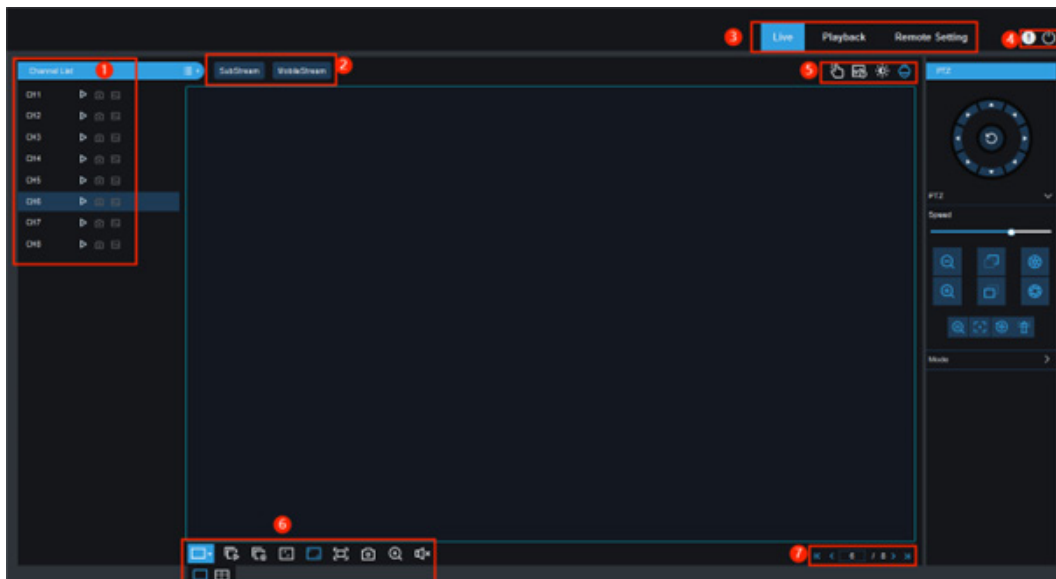



1 – Channel list

 Click this icon to display the channel list.

 Click this icon to enable or disable live video streaming. When live video streaming is enabled, the icon is displayed in blue.

 Click this icon to start recording streaming video manually. Click this icon again to stop recording. The manually recorded video is stored on the computer. During recording, the icon is blue.

 Manual snapshot icon. Click this icon to store the real time snapshot currently displayed on the computer.

 Bit rate icon. For cameras, main stream, substream, or mobile stream video settings can be used. The mobile stream setting is applicable to IP channels only.

2 – Stream switching

The web client is automatically switched to main stream mode when videos are viewed in a single split-screen and substream mode when videos are viewed in multiple split-screens. You can select the appropriate stream mode for video viewing in accordance with the actual network environment.

3 – Main menu

Live: Get video streams of the device in real time.

Playback: Remotely play the videos stored on the device.

Remote Setting: Remotely set parameters of the device.

EN

4 – Information

 Hover the mouse to display system user and web version information.

 Exit the web client.

5 – Manual Alarm



Color: Show or hide the color controls.

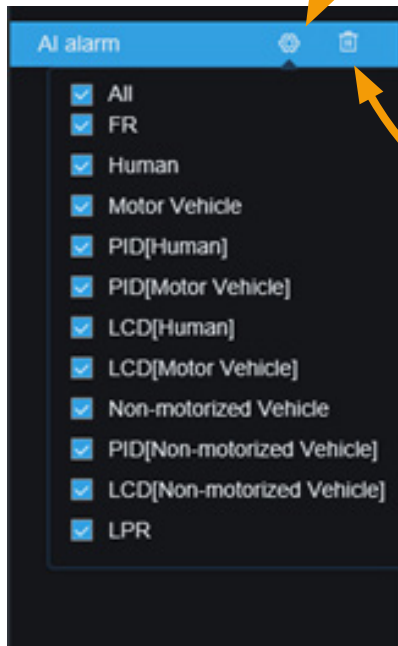

AI alarm: Push AI alarm events.

Click to select the types of the AI alarm events to be pushed.

Click to clear the current push list.

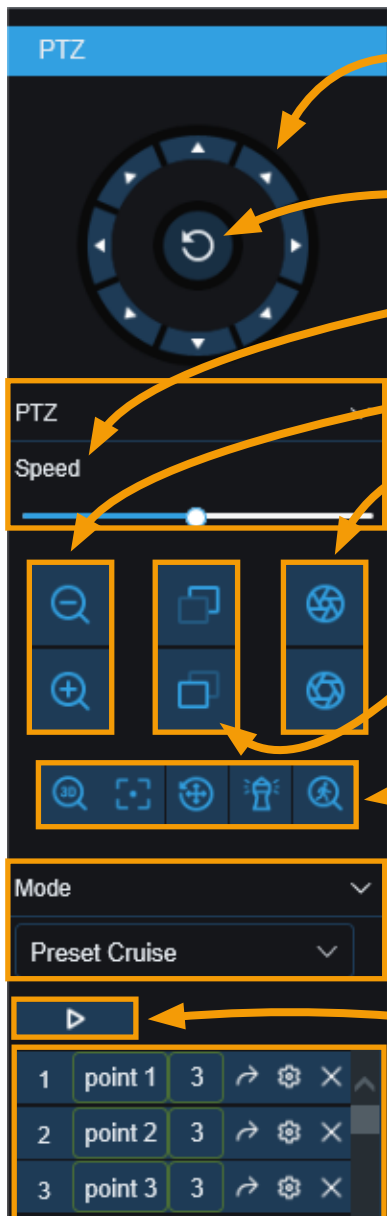

PTZ: Enable or disable the PTZ operation menu.

Arrow keys: Click the arrow keys to rotate the PTZ camera.

Default cruise:

PTZ speed: Set the rotation speed of the PTZ camera.

Zoom: Click -/+ to zoom in or out the image.

Iris: Adjust the iris size.

Focus: Click -/+ to adjust the focus.

3D PTZ

Automatic focusing

Preset point resetting

Watch mode

Manual tracking mode



PTZ rotation mode. There are six modes: PTZ, PRESET, Line Scan, Watch Mode, Tour, and Pattern Scan. For detailed information, see 5.1.4.1 High-speed PTZ Camera Control.

Cruise: Start/stop PTZ cruise.

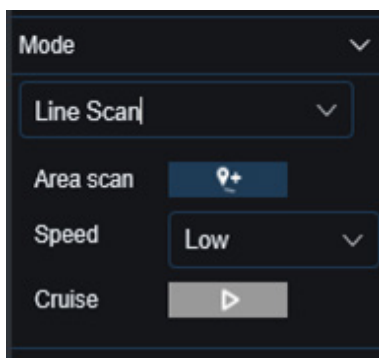
Preset points: Modify the names of preset points, and go to, add, or delete preset points.



Line Scan page

Area scan: Click  to record the start position and rotate the PTZ camera, and click  to record the stop position.

Speed: Select the linear cruise speed.

Click  to start linear cruise. In this mode, the PTZ camera moves on the same horizontal plane only.

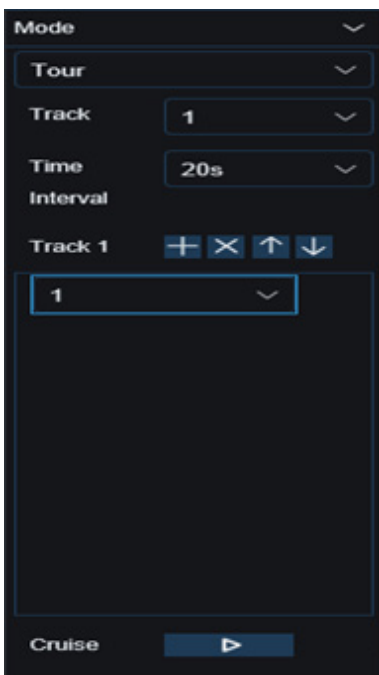



Tour page

Time Interval: Dwell time at each preset point.

Click  to add a preset point.

Click  to delete the preset point.

Click  /  to move up/down the preset point.

Click  to start cruise.

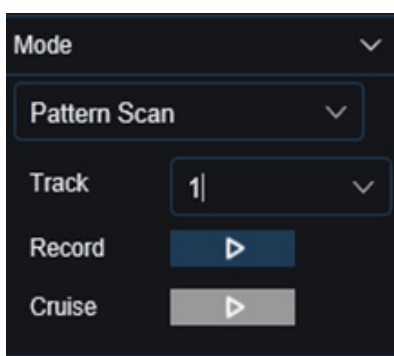

Pattern Scan page:

Record:

Click  to start recording the cruise route.

















Click  to stop recording.

Cruise:

Click  to start cruise in accordance with the recorded route and action.

6 – Live View Control Buttons



-  Switch display mode in the channel area.
-  Open all channel previews.
-  Close all channel previews.
-  Original proportions: The live video is displayed in the original proportions.
-  Stretch: The live video is stretched to fit the entire area of each channel on the screen.
-  The web client is enlarged to full screen.
-  Manual recording: Click this icon to start manual recording of all displayed channels. Click this icon again to stop recording. The manually recorded video is stored on the computer.
-  Manual capture: Click this icon to capture the images of all displayed channels and store them on the computer.
-  Digital zoom: Click an active image, and drag and drop the mouse to get an area on the active image to zoom it in. Right-click the area to return to normal view.
-  Volume control: Adjust the volume by adjusting the level value.
-  Silence mode.
-  Intercom: Click this icon to enable the intercom between the client and the device. Click this icon again to disable the intercom with the device. (Note: This function needs to be supported by the device.)
-  White light control. White light deterrence can be enabled manually (camera support is required).
-  Alarm bell control. Alarm bell can be enabled manually (camera support is required).
-  Warning light control. Warning light alarm can be enabled manually (camera support is required).
-  Click this icon to add a custom tag event.

7 – Display tab switching

8.3.2 - Playback Page

On this page, you can search and play back the videos stored on the hard disks of the device, and can download videos to a PC.



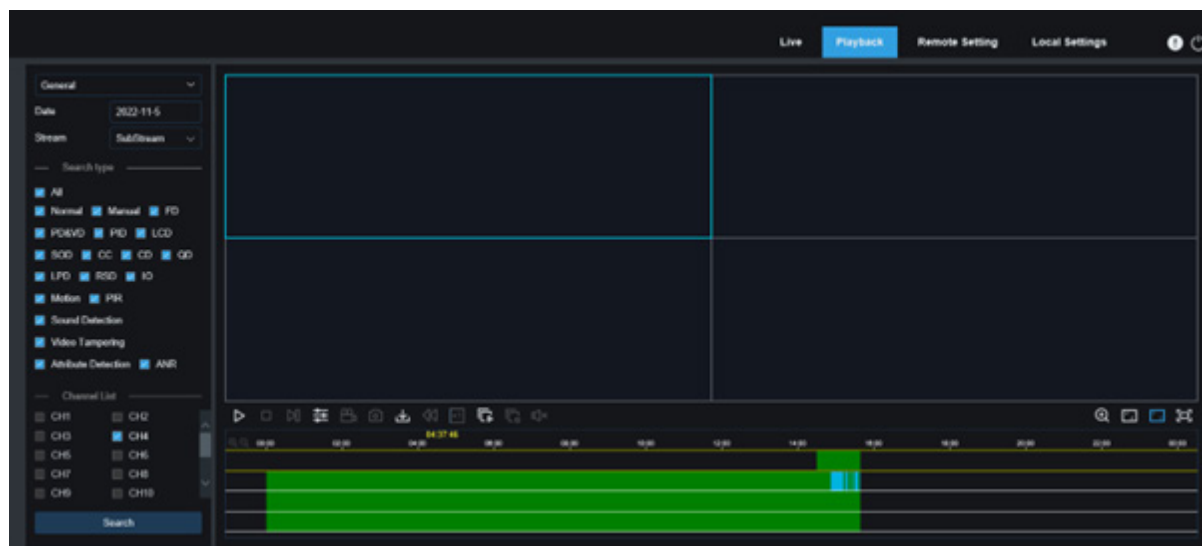





EN



Searching Videos:

1. Click **Playback** in the top right corner to open the **Playback** page.
2. Select the date for video query on the calendar. The days with video recording are underlined in red.
3. In the **Search type** area, select the recording types to be queried. You can also select All to query all recording types.
4. Select the video streams to be searched and played.
5. In the **Channel List** area, select the channels of which videos are to be played back. (You can search at most four channels for video playback at the same time.)
6. Click the **Search** button to search videos.
7. The searched videos are displayed on the timeline. Click the video clip to be played, and click ▶ to play the video.

8.3.2.1 - Playback Control Icons

-  **Play** a single video.
-  **Pause** a single video.
-  **Stop playing** the video of a single channel.
-  **Play videos frame by frame:** Move forward by one frame, that is, move the frames one by one through playback. It is available only when the synchronous playback option is not selected.
-  **Synchronous playback:** Click this icon to synchronously play the videos of the selected channels in the same time period.
-  Click this icon to select a **channel** being played, and then click the record icon to record the current video to the computer. Click this icon again to stop recording.
-  Select a channel being played, and click this icon to take a **snapshot** and store it on the computer.
-  Click this icon to open the **download** page, on which you can select the videos of the selected time ranges of selected channels.

Select the files to be downloaded, and click the **Start Download** button to start downloading. The download status is displayed. Click the **Stop Download** button to stop downloading.

-  **Rewind videos:** It is available only when the synchronous playback option is not selected.

-  **Playback speed:** Click this icon to select the playback speed.

-  **Play all channels:** Click this icon to play all channels of the selected search types. It is available only when the synchronous playback option is not selected.

-  **Stop playing all channels:** Click this icon to stop playing all channels. It is available only when the synchronous playback option is not selected.

-  **Digital zoom:** Click a video being played, and drag and drop the mouse to get an area on the video to zoom it in. Right-click the area to return to normal view.

-  **Original proportions:** The video is displayed in the original proportions.

-  **Stretch:** The video being played is stretched to fit the entire area of each channel on the screen.

-  The web client is enlarged to **full screen**.

	<input type="checkbox"/>	Start Time	End Time	Status	File Size
1	<input type="checkbox"/>	2021-02-20 00:00:00	2021-02-20 00:06:01	Not Downloaded	180.91M
2	<input type="checkbox"/>	2021-02-20 00:06:01	2021-02-20 00:14:28	Not Downloaded	253.81M
3	<input type="checkbox"/>	2021-02-20 00:14:28	2021-02-20 00:22:58	Not Downloaded	253.99M
4	<input type="checkbox"/>	2021-02-20 00:22:58	2021-02-20 00:31:24	Not Downloaded	253.73M
5	<input type="checkbox"/>	2021-02-20 00:31:24	2021-02-20 00:39:49	Not Downloaded	253.62M
6	<input type="checkbox"/>	2021-02-20 00:39:49	2021-02-20 00:48:19	Not Downloaded	253.86M
7	<input type="checkbox"/>	2021-02-20 00:48:19	2021-02-20 00:56:49	Not Downloaded	253.90M
8	<input type="checkbox"/>	2021-02-20 00:56:49	2021-02-20 01:05:18	Not Downloaded	253.83M
9	<input type="checkbox"/>	2021-02-20 01:05:18	2021-02-20 01:13:44	Not Downloaded	253.55M
10	<input type="checkbox"/>	2021-02-20 01:13:44	2021-02-20 01:22:10	Not Downloaded	253.46M
11	<input type="checkbox"/>	2021-02-20 01:22:10	2021-02-20 01:30:36	Not Downloaded	253.67M
12	<input type="checkbox"/>	2021-02-20 01:30:36	2021-02-20 01:39:06	Not Downloaded	253.98M
13	<input type="checkbox"/>	2021-02-20 01:39:06	2021-02-20 01:47:35	Not Downloaded	253.62M
14	<input type="checkbox"/>	2021-02-20 01:47:35	2021-02-20 01:56:01	Not Downloaded	253.58M

14 Row / Page < 1 / 14Page >

Start Download Stop Download

8.3.2.2 - Image Playback

After the capture function is enabled for the device, you can search the captured images on this page. A maximum of 5000 images can be searched at a time, and the time interval can be modified as needed.

Searching images:

1. Click **Playback** in the top right corner of the page.
2. Select **Picture** from the drop-down list in the top left corner of the page.
3. Select the day to be searched on the calendar. The dates with snapshots are underlined in red.
4. Select the image types to be searched from the **Search Type** menu, or select **All** to search all image types.
5. Select the channels of which videos are to be searched.
6. Click **Search**.
7. The images meeting the search conditions are displayed in the right pane. If you double-click an image, the videos with the time periods before and after the image will be played back. Click to return to the previous page.

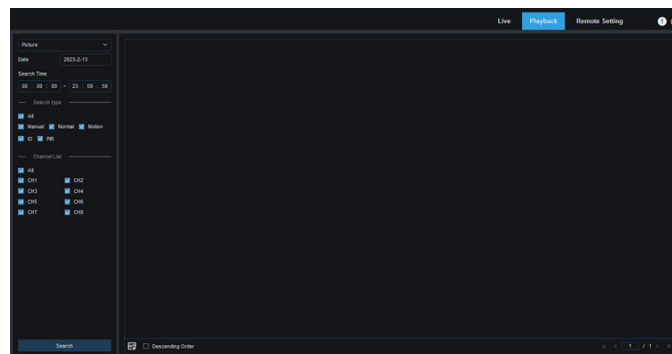

8.3.2.3 - Smart Playback

After the motion detection function is enabled for the device, if there are motion detection alarms triggered, you can search the smart playback videos.

Click to display the smart setting area.

Click to select all areas.

Click to clear all selected areas.

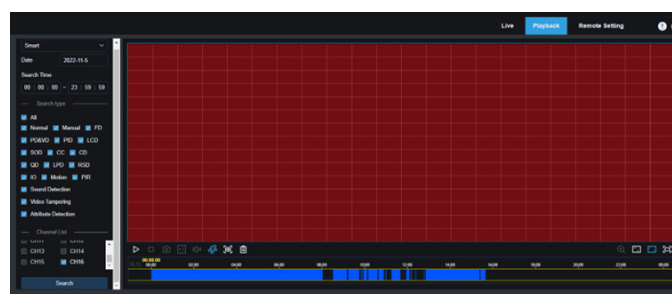

8.3.2.4 - Playback by Tag

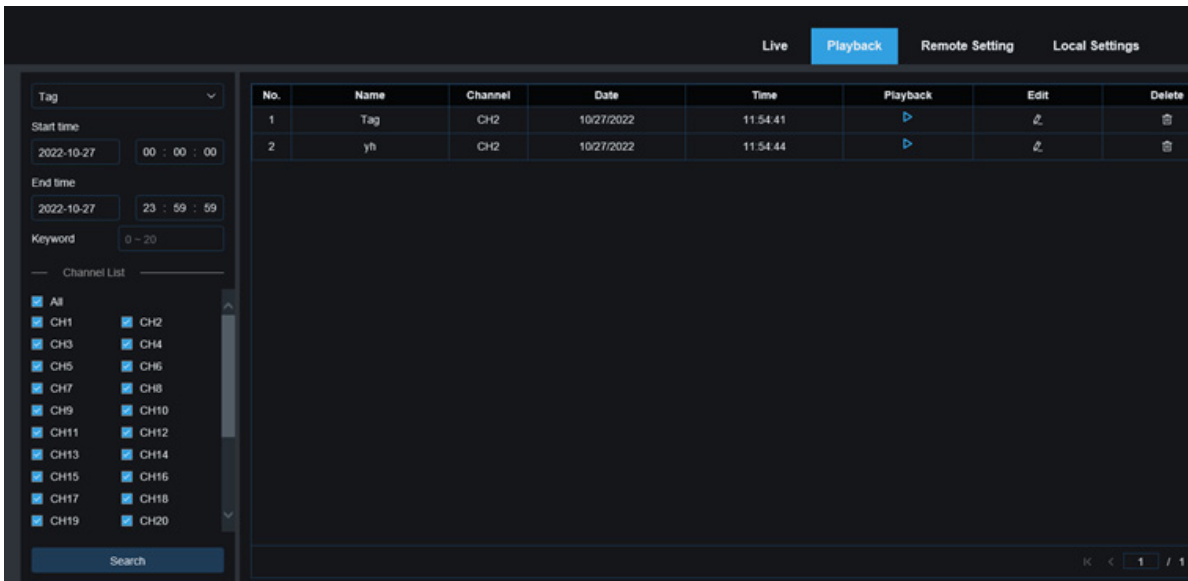

On this page you can search all added tags, and edit, play back, or delete them as needed. Select time and channels, and click 🔍 to complete the search. Click ▶ to jump to the position marked by the tag to play back the video.

8.3.2.5 - Playback

After the AI alarm function is enabled for the device, you can search AI alarm events on this page, including face detection, license plate detection, pedestrian and vehicle detection, PID&LCD, repeat customers, and face attendance events.

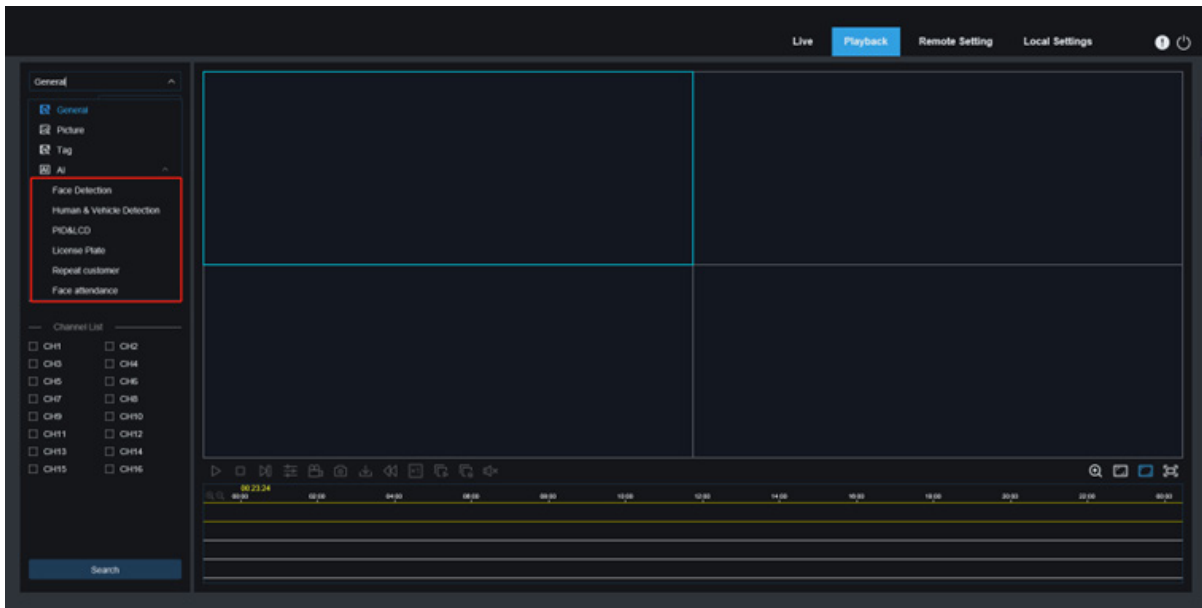

8.3.3 - Remote Setting

On this page you can remotely set device parameters, including channel, video, alarm, AI, network, device, and system parameters.

EN

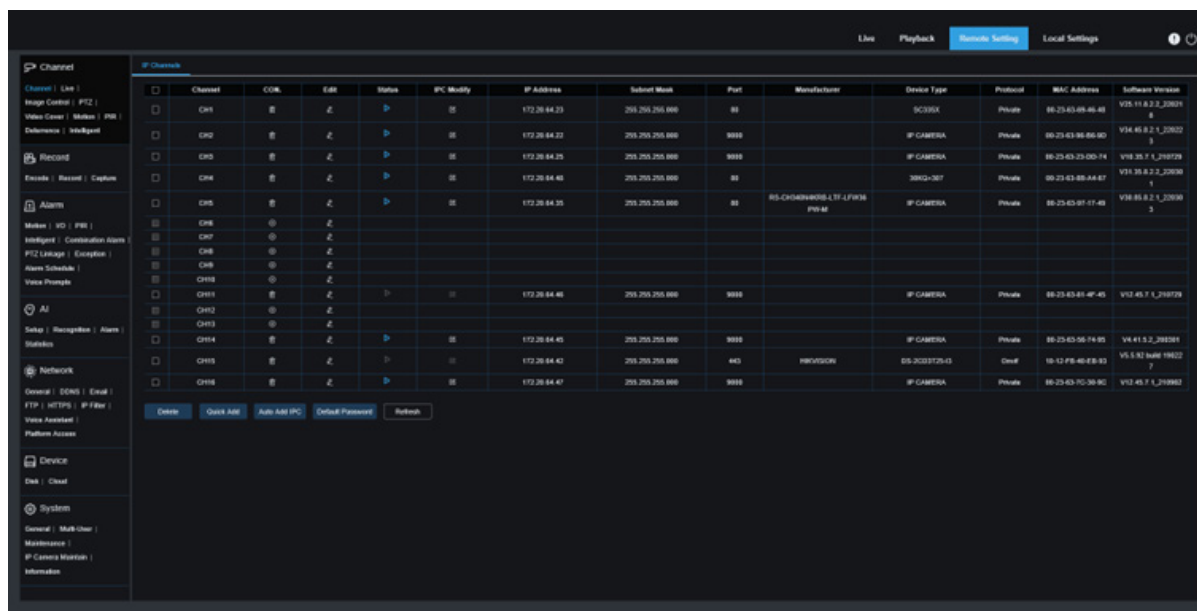

8.3.4 - Local Setting

On this page you can set where the videos and snapshots taken through the web client are downloaded, and can select the file type of the video files.

Record Path: Click to select the folder where the manually recorded videos are stored on the computer.

Download Path: Click to select the folder where the downloaded videos are stored on the computer.

Snapshot Path: Click to select the folder where the manually captured snapshots are stored on the computer.

File Type: Select the type of the manually recorded video files.

Save: Click this button to save the changes.

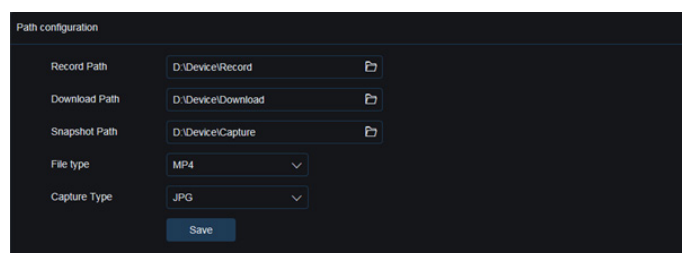

9 - BACKUP VIDEO PLAYING

This chapter describes how to use the VideoPlayer to play the video files backed up from the device.

Minimum Requirements for the Computer System

- CPU: Intel I3 or above
- Operating system: Windows XP/7/8/10/11, MacOS 10
- Memory: 2 GB
- Video memory: 1 GB



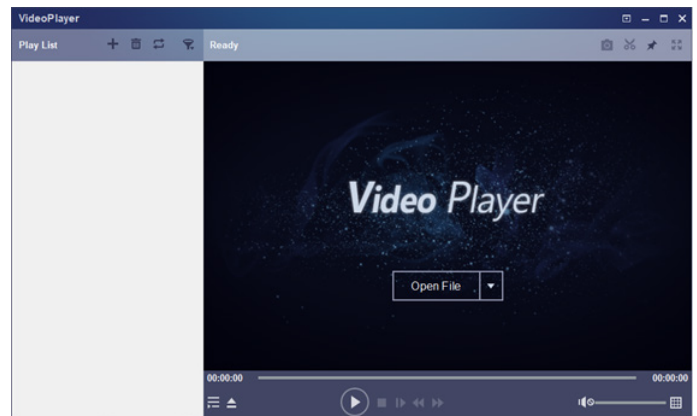

1. Install the video player software on the CD and run the program.
2. Copy the backup file to the computer.
3. Click **Open File** or click the "+" icon in the **Play List** pane to load one or multiple video files. The supported video file formats include .rf, .avi, and .mp4. Click ▼ to load a backed up video file folder.





Video Player Control









1 – Play list

-  Add files.
-  Delete files.
-  Select play mode: Play a single file and then stop; play all listed files in sequence; play one file repeatedly; play all files repeatedly.
-  Filter files by file name.

2 –

-  Hide/Show the play list.
-  Open a file or load a file folder.



3 – Play control

-  Play the video.
-  Pause playing the video.
-  Stop playing the video.
-  Play the video frame by frame: One frame is played every time this icon is clicked.
-  Play the video on a low speed: You can set the video to be played at 1/2, 1/4, 1/8, or 1/16 of the normal play speed.
-  Fast forward: You can set the video to be played at 2x, 4x, 8x, or 16x of the normal play speed.

4 – Volume control

-  Multi-screen play. Multiple videos can be played at a time. After clicking this icon, you can drag the videos in the play list to the play page.

5 – Snapshot

-  Click this icon to store a video clip on the computer. You can click it to start video clipping, and then click it again to stop video clipping.
-  Keep the video player at the top.
-  Enlarge the video page to full screen.

6 – Advanced setting menu:

Select language for the video player, and configure the player functions.

Basic Settings: Set how to keep the player at the top.

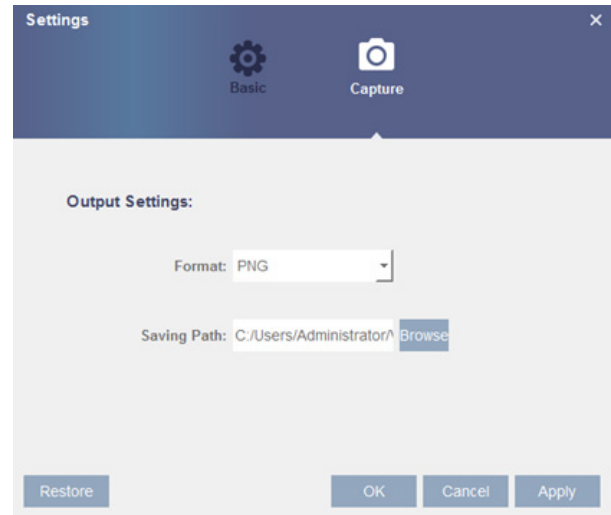
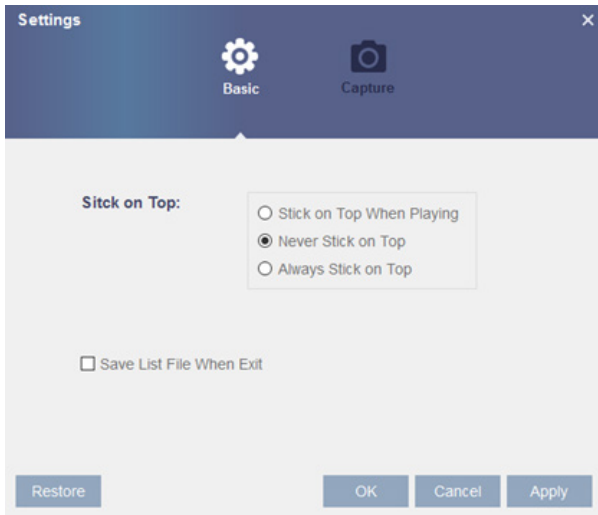



Capture Settings: Set the file format and path for snapshot saving.

10 - REMOTE ACCESS THROUGH MOBILE DEVICES

The device supports remote access through the mobile devices with Android or iOS operating systems. For such mobile devices with Android or iOS, they can obtain the RXCamView software from Google Store or Apple Store and then install the software.

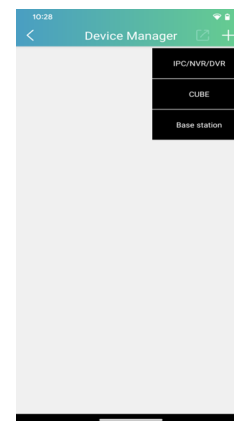
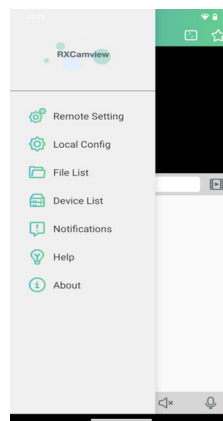
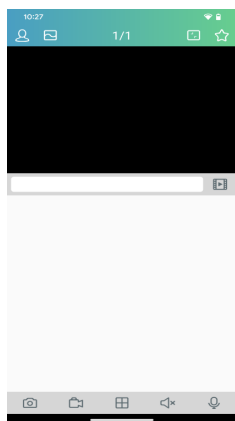
EN



1. Run the program to display the live view screen.
2. Click the  icon to open the menu, choose Device List, and then click + to add a device.
3. Click **Manual Add**, and enter the device information to add a new device.

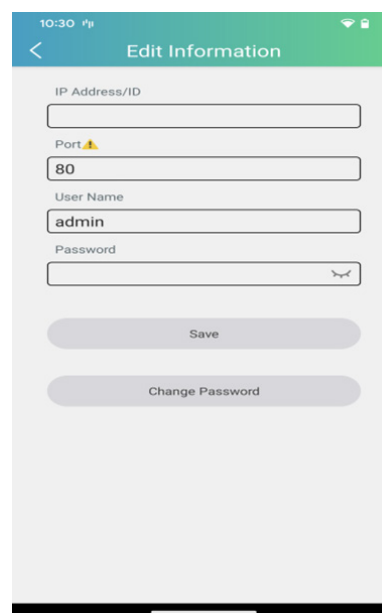
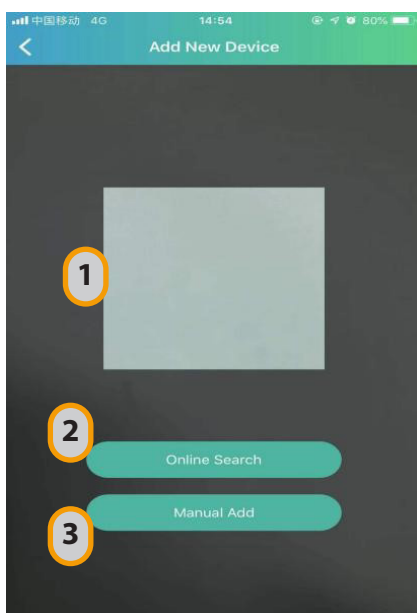





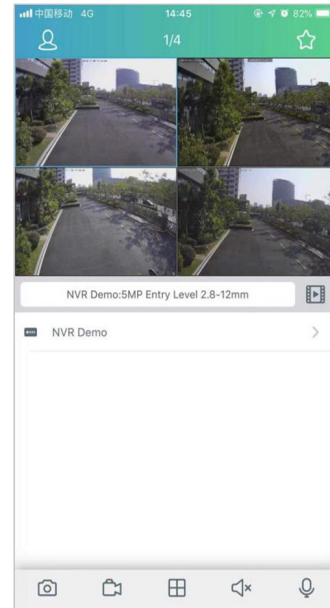

1. **Scan the QR code:** Scan the QR code to add a device.
2. **Online search:** Search and add a device in the same LAN as the device.
3. **Manual Add:**
 - **IP Address/ID:** Enter an IP address or a P2P ID.
 - **Port:** Enter the port number of the device.
 - **User Name/Password:** Enter the user name and password of the device.

4. After all settings are completed, click Save. If the device is connected properly, the app will go to realtime display status.

- 1-channel display
- 4-channel display
- 6-channel display
- 8-channel display
- 9-channel display
- 16-channel display



NOTE: This app can display at most 16 channels on one screen. You can slide a screen to the next screen to view another 16 channels. A total of 80 channels can be displayed.

-  **Capture:** Capture the images of the selected channel, and save them in the file list of the app. You can download the captured images in the file list to a mobile phone.
-  **Video recording:** Record the images of the selected channel, and save it in the file list of the app. You can download the recorded videos in the file list to the mobile phone.
-  **Audio:** Enable or disable the sound.
-  **Intercom:** Intercom: two-way device intercom (requires device support)
-  **PTZ control** (camera support required).
-  **Shut down the channel:** This icon appears at the top of the screen when you press and hold the video image. You can drag the video to the icon to close the video preview.

11 - APPENDIX

11.1 - FAQ

EN

1. What should I do if I cannot detect the hard disk?

A: If no hard disk is detected, you need to verify the following:

- (1) The data cable and power cable of the hard disk are well connected.
- (2) The ports of the hard disk on the main board are in good condition.
- (3) The hard disk is supported as described in the specifications.

2. What should I do if I forget the password after I change it?

A: When the administrator forgets the password, you can reset the password through the password retrieval function or restore the factory settings of the device through the physical reset button. It is recommended that you set a password that is both easy to remember and relatively secure.

3. After the device and cameras are connected, the power supply on both ends are normal, but there are no video signals or the outputted images are not normal. Why?

A: Verify that the network cable on the device end is connected properly and is not aging, and verify that the NTSC/PAL system configurations are the same on both ends.

4. What is the effect of heat dissipation on the device itself during operation?

A: Because a certain amount of heat is generated during the device operation, you need to place the device in a safe and well-ventilated environment to prevent the device from having long-term high temperature, which may affect the stability and service life of the system.

5. Why can't the remote control of the device operate while the monitoring screen is normal and the panel buttons can be used?

A: Align the remote control with the IR signal on the front panel of the device when performing check operations. If the remote control still fails, check whether the remote control have sufficient battery capacity. If yes, verify that the remote control is not damaged.

6. Can I use the hard disk drive on my PC in the device?

A: It is recommended that you use a hard disk dedicated for video surveillance to ensure the stability of device operation.

7. Can I play back videos while recording videos?

A: Yes. This device supports that you record videos and play back videos simultaneously.

8. Can I clean up some video records on the hard disk?

A: Considering file security, you cannot clean up some video records. If you really need to delete all the video records, you may format the hard disk.

9. Why can't I log in to the device client?

A: Verify that the network connection configuration is correct and the RJ-45 port has good contact. If the network login password switch is enabled, verify that the user name and password you entered are correct.

10. Why can't I find any recorded information when playing back videos?

A: Verify that the data cable of the hard disk is connected properly and the system time is not adjusted without permission. Try for several times. If the problem persists after restarting, verify that the hard disk is not damaged.

11. Why can't the device control the PTZ?

A: The problem may due to the following causes:

- a) The front-end PTZ is faulty.
- b) The setting, connection, or installation of the PTZ decoder is incorrect.
- c) The PTZ of the device is not configured correctly.
- d) The PTZ decoder protocol does not match the device protocol.
- e) The PTZ decoder address does not match the device address.

12. Why doesn't dynamic detection work?

A: Verify that the motion detection time and motion detection area settings are correct, and verify that the sensitivity setting is not too low.

13. Why do the alarms fail?

A: Verify that the alarm setting, alarm connections, and alarm input signals are correct.

14. Why does the buzzer keep ringing?

A: Check the following items: alarm settings, whether the motion detection function is enabled, whether there are always moving objects detected, and whether the I/O alarm is disabled. Verify that the hard disk alarm settings are correct.

15. Why is the device still in recording status even when I click the Stop icon or click Stop Recording in the shortcut menu?

A: If you click the Stop icon or click Stop Recording, only manual recording is stopped. To stop scheduled recording, you need to change the recording status within a certain period of time to not recording. To stop power-on recording, you need to change the recording mode to scheduled recording or manual recording, and then stop recording as described above. Or, you can set the channel status to disabled.

11.2 - Use and Maintenance

1. To turn off the hard disk recorder, first turn off the system on the software GUI, and then turn off the power supply. Do not turn off the power supply directly to avoid data loss or even damage of the hard disk.
2. Ensure that the hard disk recorder is far away from the places with high temperature heat sources.
3. Regularly remove the dust deposited inside the device, and keep good ventilation around the case of the hard disk recorder to facilitate heat dissipation.
4. Do not hot-plug the audio and video signal cables and interfaces such as RS-232 and RS-485; otherwise, such interfaces may be damaged.
5. Regularly check the power cable and data cable inside the device to prevent them from aging.
6. Try to avoid the impact of other electric appliances on audio and video signals, and prevent the hard disk from being damaged by static electricity or induced voltage.
If the interface connecting the network cable is frequently plugged in and pulled out, it is recommended that you replace the connection cable regularly to avoid unstable input signals.
7. The device is a Class-A product. In the living environment, the product may cause radio interference. In such cases, practical measures should be taken to cope with the interference.



eneo® is a registered trademark of
Videor E. Hartig GmbH
Exclusive distribution through specialised
trade channels only.

Videor E. Hartig GmbH
Carl-Zeiss-Straße 8
63322 Rödermark / Germany
Tel. +49 (0) 6074 / 888-0
Fax +49 (0) 6074 / 888-100
www.videor.com
www.eneo-security.com

Technical changes reserved

© Copyright by Videor E. Hartig GmbH
Version 01/2024