



EN

User Manual

**1/2.5" Network Dome, Fix,
3840x2160, Day&Night, DOL-WDR
3.6-11mm, Infrared, IP67**

IPD-78M3611M5A

Safety Precaution

To prevent electric shocks and risk of fire hazards, do NOT use other than specific power source.

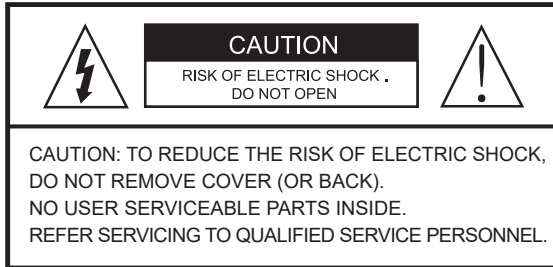

The symbol is intended to alert the user to the presence of uninsulated "dangerous voltage" within the product's enclosure that may be of sufficient magnitude to constitute a risk of electric shock to persons.



The symbol is intended to alert the user to the presence of important operating and maintenance(servicing) instructions in the literature accompanying the unit.

- **Warning :**

This equipment has been tested and found to comply with the limits for a Class A digital device, pursuant to part 15 of the FCC Rules. These limits are designed to provide reasonable protection against harmful interference when the equipment is operated in a commercial environment. This equipment generates, uses, and can radiate radio frequency energy and, if not installed and used in accordance with the instruction manual, may cause harmful interference to radio communications. Operation of this equipment in a residential area is likely to cause harmful interference in which case the user will be required to correct the interference at his own expense.

- **Caution :**

Any changes or modifications in construction of this device which are not expressly approved by the party responsible for compliance could void the user's authority to operate the equipment.

Mains power quality should be that of a typical commercial environment. If the user of the model requires continued operation during power mains interruptions, it is recommended that the model be powered from an uninterruptible power supply (UPS) or a battery.

Safety Precaution

NOTICE

- The image used in this instruction manual are processed to help comprehension and may differ from actual video of the camera.
- Avoid installing areas where has shock or vibration which results in the problems.
- Pay attention to safety when laying the connection cable and observe that the cable is not subjected to heavy loads, kinks or damage and no moisture can get in.
- Never open the device such as boards or lens.
The warranty becomes void if repairs are undertaken by unauthorized persons.
- Maintenance and repair have to be carried out only by authorized service centers.
- Use only a mild detergent to clean the housing body.
- The camera should never be operated beyond the technical specifications.
This can lead to destruction.
- The camera should never be operated in water.

Contents

Safety Precaution	03~04p
Contents	05p
Features	06p
Composition	07p
Dimensions	07p
Part Names	08p
Installation Instructions	09~12p
Specifications	13~14p
Operating Instructions	15~18p
Full Menu Setup	19~74p
1. LIVE VIEW	19p
2. PLAYBACK	21p
3. SETUP	22p
3-1. Information	22p
3-2. Video & Image	22p
3-3. Audio	38p
3-4. Record	39p
3-5. Event	42p
3-6. System	59p
4. 4 EYES PRINCIPLE	70p
Troubleshooting	71~72p

Features

- 8.29Mega Pixel, NETWORK CAMERA, 3840x2160(30/25fps)
- ONVIF Conformance, Zero configuration
- Cross Web Browsing (IE, Edge, Safari, Firefox, Chrome)
- Adaptive web resizing depending on layout & resolution of display device by RESPONSIVE WEB
- Increased usability for all PC, tablet and mobile
- Simultaneously H.265(+), H.264(+) & MJPEG (Quad streaming)
- ONVIF Event Mapping
- HTML5 playback for recorded video on Micro SD card
- 2 Way Audio & Alarm input/output
- f= 3.6~11mm, 3x Motorized zoom lens
- Motorized Zoom & Focus Adjustment
- DOL WDR (Digital Overlap Wide Dynamic Range)
- D-WDR (Digital Wide Dynamic Range)
- Improved noise figure with the enhanced 3DNR
- LDC(Lens Distortion Compensation)
- Smart Stream, ROI(Region of Interest)
 - Enables to process video data smartly according to users demand.
 - Available to deliver high quality video on interested region while less quality video on non interested region.
 - Lowering overall bandwidth and reduce the storage burden
- Privacy Mask, Motion Detection, Defog, HLC/ BLC, Digital Zoom(~x10), Mirror/Flip, Contrast, Brightness, Hue, Saturation, Sharpness, DIS (Digital Image Stabilization)
- Circuit protection against faulty connection in power polarity
- Isolated power supply against ground loop problem
- PoE(IEEE Std. 802.3af) & AC24V/DC12V
- Built-in 2pcs High power SMD LED
- Built-in Fan & Optimized Cooling system
- Double side Anti-Scratch Hard coated clear bubble dome
- IP67/IK10 Protection

Composition

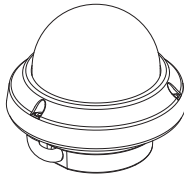

Dome Camera

Plastic Anchor:
6 x 30mm (3pcs)



Mounting Screw:
4 x 30mm (3pcs)



Connector fixing Screw:
2.5 x 5mm (1pc)



Torque Wrench:
3mm (1pc)

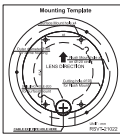

Mounting
Template

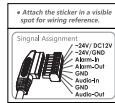

Cable Signal
Sticker

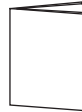

Operating
Instruction



Wiring Connector
(1pc)

Dimensions

(unit : mm)

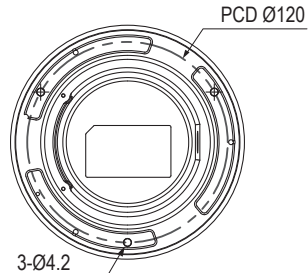
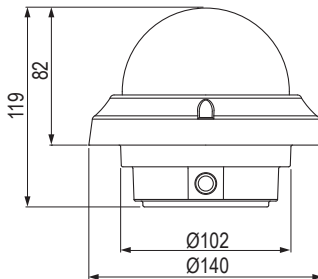
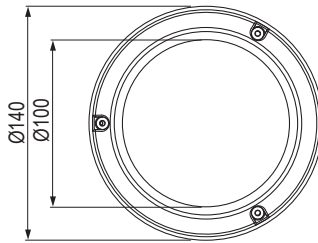

Part Names

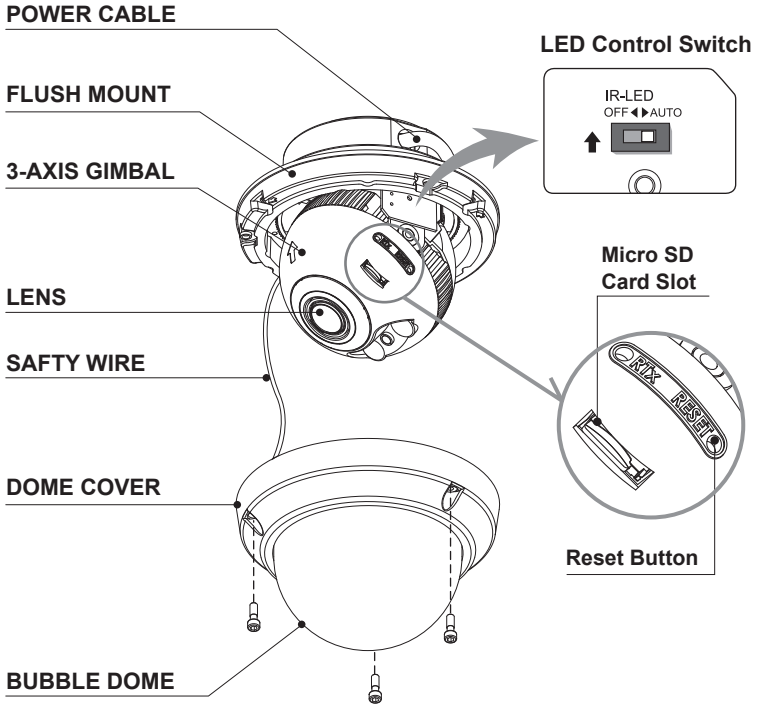

[BOTTOM VIEW]

ETHERNET & POWER CABLE

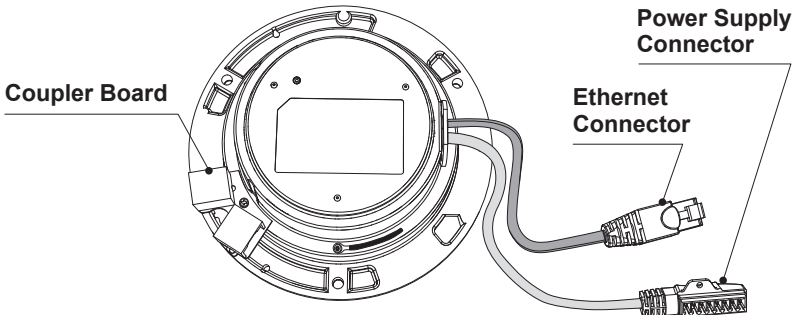

Installation Instructions

1. Locate the mounting template at the installation position and drill the ceiling or wall if needed.
2. Open the dome cover by loosening screws(4x12mm). Use the torque wrench supplied.
 - Place the dome base unit on pre-drilled position and fix it through using mounting screws (4x30mm).
 - Route the power cable to the connecting place.
3. Set the camera's viewing angle.
4. Put the dome cover to the dome base unit and tighten the assembly screws.

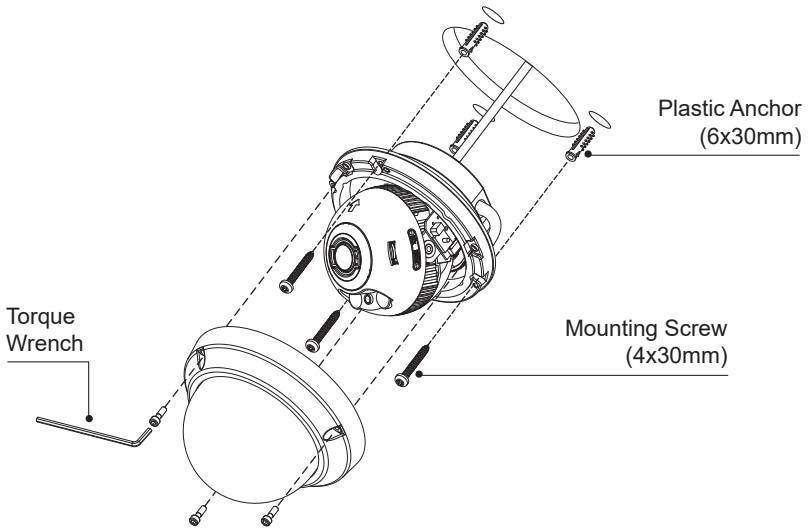

■ Optional Mounting Accessories

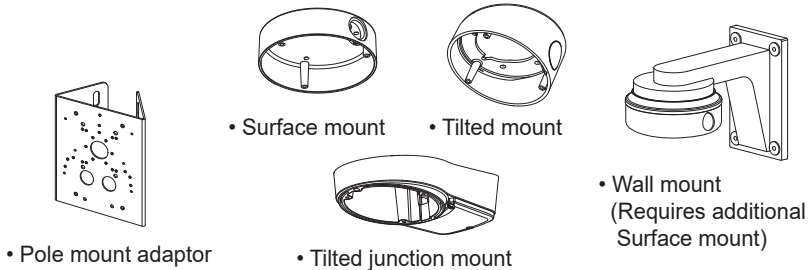

Installation Instructions

■ Option 1.

Installation with Flush mount / Tilted Junction mount

- ① Cables are unfixed on the Dome base.
 - ② Disassemble coupler board for LAN cabling.
 - ③ Connect the ethernet and power cables to their respective connections.
- * Refer to the instruction guide for Tilted Junction mount .*

■ Option 2.

Installation with Surface mount / Tilted mount

- ① Cables are unfixed on the Dome base.
- ② Organize the cables to fix the dome base as illustrated.
Fix the power supply connector with fixing screw.
- ③ Connect the ethernet cable to the coupler board.
- ④ Tie up the cables with the cable holders.
- ⑤ Check the final view for cable exit.
- ⑥ Connect the wiring connector to their respective connections.

** Refer to the signal assignment for wiring connection.*

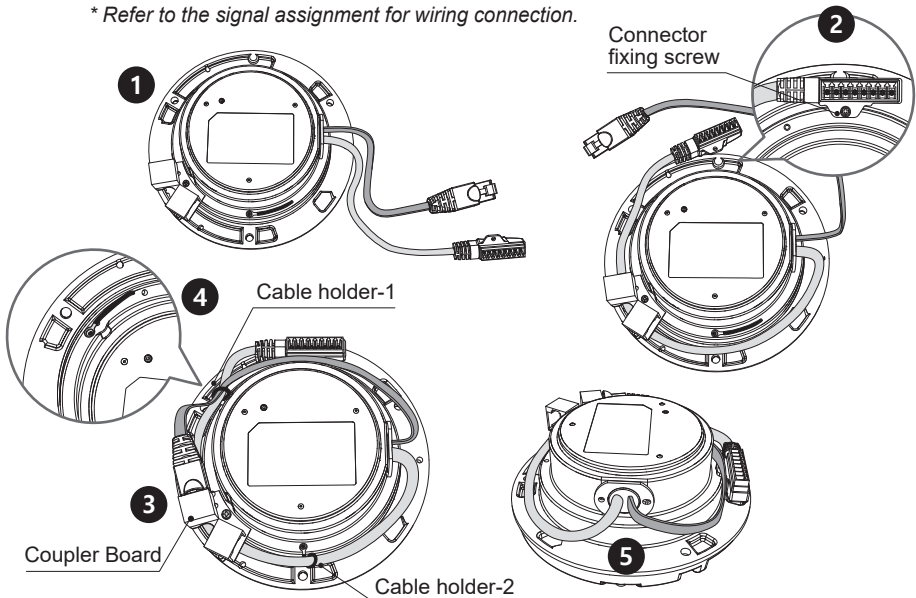

! CAUTION

- In the case of installation with Flush/ Surface/ Tilted mount, IP protection rating is not guaranteed.
- If power, Video, Network connectors are exposed to water or rain, separate protection shield is essential.

Installation Instructions

Limit of pan & tilt

1) Pan limit:

Pan is limited to $\pm 173^\circ$.

Do NOT force to turn the gimbal over the limit to prevent from the internal damage.

2) Tilt limit:

Tilt is limited to 25° min $\sim 90^\circ$ max. with reference to the ceiling when the rotation of camera module is 0° , that is, the image is aligned horizontally.

3) Rotation limit (Horizontal image alignment):

Rotation is limited to $\pm 95^\circ$ max.

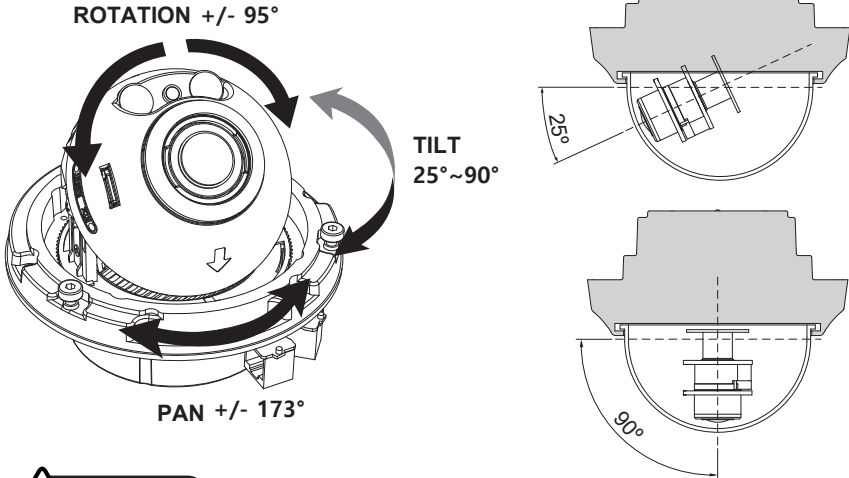

CAUTION

- Extreme care should be taken NOT to scratch the bubble dome surface while the camera installing or adjusting.
- Care should be taken the cable is NOT to be damaged, kinked or exposed in the hazardous area.
- Tighten enough the dome cover fixing screws so that there should be NO gap between Lens hood and clear bubble to avoid the light inflow from IR LEDs.

Installation and commissioning Instructions

- Make sure the power is removed before the installation.
- After all connections are finished properly, follow the order for applying power.

Installation Instructions

- a) Plug the network cable into RJ-45 Ethernet Port.
If PoE is the unique power, there will be no need to connect Power terminal.
 - b) When DC12V or AC24V Local power is necessary, connect the low voltage (DC12V or AC24V) first, then plug the AC adapter to AC outlets to avoid an improper reset from power jitter and a damage from the surge voltage when no load.
- When PoE and Local dual power are connected at the same time, Local power has priority.

Power Supply Connections

Camera can work with either 24VAC or 12VDC, dual voltage power and PoE (IEEE Std. 802.3af). Primary and secondary grounds are completely isolated to avoid the possible ground loop problems.

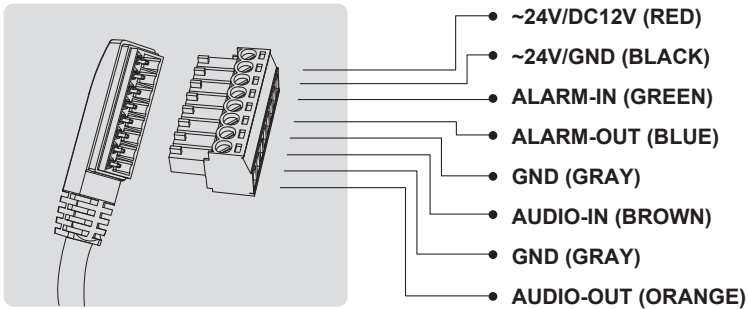

Attach the Signal Assignment Sticker in a visible spot for wiring reference.

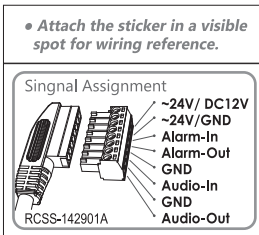

Specifications

ITEM	NTSC	PAL
Imaging Sensor	1/2.5" Sony 8.29Mega pixel RGB Bayer Array CMOS STARVIS Sensor	
Effective Pixels	3840(H) x 2160(V) approx. 8.29 Mega pixels	
Sensitivity	Color : 0.2 Lux, B/W : 0.02 Lux (Sens-up OFF)	
Scanning mode	Progressive Scan	
S/N Ratio	50dB	
Lens	3.6~11mm, 3x Motorized zoom lens	
LEDs	Built-in 2pcs x 850nm High power LED	
Day & Night mode	ICR by Auto, Day, Night, External, Color D/N	
Auto Exposure	Automatic (Priority: Frame rate/Low noise), Manual	
Shutter Speed Control	Automatic: Min. 1/10,000 sec ~ Max. 1/25 sec Manual: Min. 1/10,000 sec ~ Max. 1/25 sec	
Gain Control	Automatic: ~ Max. 39dB / Manual: ~ Max. 39dB	
Auto White Balance mode	ATW-Indoor/Outdoor, Shade, Clear sky, Fluorescent light, Light bulb, Flame, Manual	
WDR	DOL WDR (Digital Overlap Wide Dynamic Range)	
DNR	2D-NR, 3D-NR	
Functions	Motion Detection, Privacy Mask, Defog, D-Zoom(~x10), Mirror/Flip, Sens-up(Slow shutter), Brightness, Contrast, Saturation, Sharpness, Hue, LDC, VerticalView(90°/270°), VCA (Video Contents Analysis)	
Installation Temp.	-20°C ~ +50°C (Humidity : 20%RH ~ 80%RH, Non-condensing)	
Operating Temp.	-40°C ~ +50°C (Humidity : 20%RH ~ 80%RH, Non-condensing)	
Dimension	140mm(W)x119mm(H) Ø100-bubble / About 1kg	
Housing	IP67/IK10, Aluminum Cast, 3-Axis gimbal, Double side Anti-scratch hard coated clear bubble	
Power Source	PoE(IEEE Std. 802.3af), AC24V/DC12V Circuit protection against faulty connection in power polarity. Isolated power supply against ground loop problem.	
NETWORK SPECIFICATION		
Video Compression	H.265(+) Main profile, H.264(+) High, Main, Base line profile MJPEG	
Video Resolution	3840x2160(4K), 2592x1520, 1920x1080, 1600x900, 1280x720, 960x540, 640x360, 320x180	
Video Frame Rate	Up to 30/25fps@3840x2160p	
Video Streaming	Simultaneously H.265(+), H.264(+) & MJPEG (Quad streaming) Independent Frame Rate and Bandwidth Control, VBR/CBR	
FTP Uploading	MJPEG Still Image	

Specifications

Login Authority	Administrator, Operator, Guest
Security	Multi User Authority, IP Filtering, HTTPS, Video Stream, Export/Import
Network Time Sync.	Synchronize Computer/NTP Server, Manual
Software Reset	Restart, Reset, Factory Default
Auto Recovery	Backup, Restore
Remote Upgrade	Using Web Browser
Protocol	TCP/IP, UDP, IPv4/v6, HTTP, HTTPS, FTP, UPnP, RTP, RTSP, RTCP, DHCP, ARP, Zeroconf, Bonjour
Client Software	Built-In Web, ONVIF Compatible 3rd Party VMS
SDK Support	API, ONVIF Profile S Compliant
SD memory card	Slot for Micro SD memory card (H.264 recording)
Audio & Alarm	2way Audio & Alarm input / output

(*) Design and specifications are subject to change for product improvements without prior notice.

Operating Instructions

Setup Menu table

Category	Menu	Configuration			
LIVE VIEW	Player Control	Pause, Snapshot, Speaker, Microphone, Record			
		Display (Window Fit, Full Screen, Custom)			
	Video Stream	Stream1, Stream2, Stream3, Stream4			
	Protocol	HTTPS, HTTP, TCP, UDP			
	PTZ Control	Zoom, Focus, Push AF			
PLAYBACK	Event Search, Timeline Search, Timeline Bar				
SETUP	Information	General, System Information, Open source Information			
	Video & Image	Source			
		Stream1/2/3/4			
		Smart Video Stream	ROI(Region Of Interest), Dynamic GOP		
		Image	Basic	Brightness, Contrast, Saturation, Hue, Sharpness, Enable flip image, Enable mirror image	
			OSD	Enable text OSD, Enable date&time OSD, Enable zoom&focus OSD	
			AE	Mode, Slow shutter, Luminance compensation, Auto Iris, Auto Flickerless, Shutter, Max. Shutter, Gain, Max. Gain	
			AWB	Mode, RGain, GrGain, GbGain, BGain	
			AF	Mode, Speed, Lens Locking, Locking Timer, Lens Calibration, Enable Day& Night sync focus, Lens initialize on boot	
			Day&Night	Mode, Switching time, Threshold(D->N), Threshold (N->D)	
			WDR	WDR(Mode, Level), DWDR(Mode, Level), Defog(Mode, Level)	
			BLC	BLC(Mode, Level), HLC(Mode)	
			DNR	Mode, Level	
			LDC	Mode, Level	
		VerticalView	Mode, Rotation		
		Privacy Mask	Color, Name		
	Digital Zoom	Level			
DIS					
Audio	Compression, Sample rate, Bitrate, Input Volume, Output Volume, Audio auto activation on ONVIF access				

Operating Instructions

SETUP	Record	Record	Overwrite when storage is full, Continuous record setting
		Schedule	
		Recycling	Recycling Time Setting
		Storage	Format, Remove, Storage Information
	Event	Triggers	Motion, VCA, Alarm In, System, Manual, Network, Timer, Day/Night, Audio Detect
		Actions	Record, Alarm Out, E-Mail, FTP, Video Boost, Notification Server
		Rules	Event Processing, ONVIF Mapping
	System	Security	User, HTTPS, IP Filter, ONVIF, Video Stream, Export/Import
		Date & Time	Current Time, New Time, Time Zone, Date & Time Display
		Network	TCP/IP, DDNS, RTP, UPnP, Zeroconf, Bonjour
		Language	English, Deutsch, Français, 한국어
		Maintenance	Maintain (Restart, Reset, Default), Upgrade, Setup Export, Setup Import
		Logs & Report	Logs (Database Capacity, Search Condition, Log List), Log Sever, Report
4 EYES PRINCIPLE	Approval #1/2		
LOG OUT			

Operating Instructions

Quick Network Setup

■ Log in the web viewer

1. After the camera is connected to the network, start '**eneo Site Manager**' tool. (downloadable from www.eneo-security.com).
2. You will get a list of cameras connected to the local network. Highlight your camera in the list and open a context menu with a click of the right mouse button.
3. Select the „Set IP Address [dhcp / static]“ option to open a window for setting the cameras IP properties. When you are done click the „OK“ button to update the camera settings.
4. By default the camera is set to DHCP. If there is no DHCP server present in the network the camera will fall back to a default IP address after a while. In this scenario please only add one camera at a time to the network to avoid conflicts due to identical IP addresses. The network camera's default IP address is: **192.168.1.10**.
5. Right clicking the device name in the eneo Scan Device tool will bring up the context menu. Use the '**Open Device Web Site**' option to access the camera.
6. The web viewer login page will open up in your default web browser. In case of Microsoft Internet Explorer install Active-X named VIDEOR E. Hartig GmbH according to the instruction at the bottom of the browser.
7. Use the default user name and password to log in.

Default user name: admin

Default password: admin



eneo xxx-xxxxxxxxxx

admin

.....

Jump to setup

Login

Full Menu Setup

1. LIVE VIEW

Enter the live view menu on the Web Viewer.

■ Web Viewer description

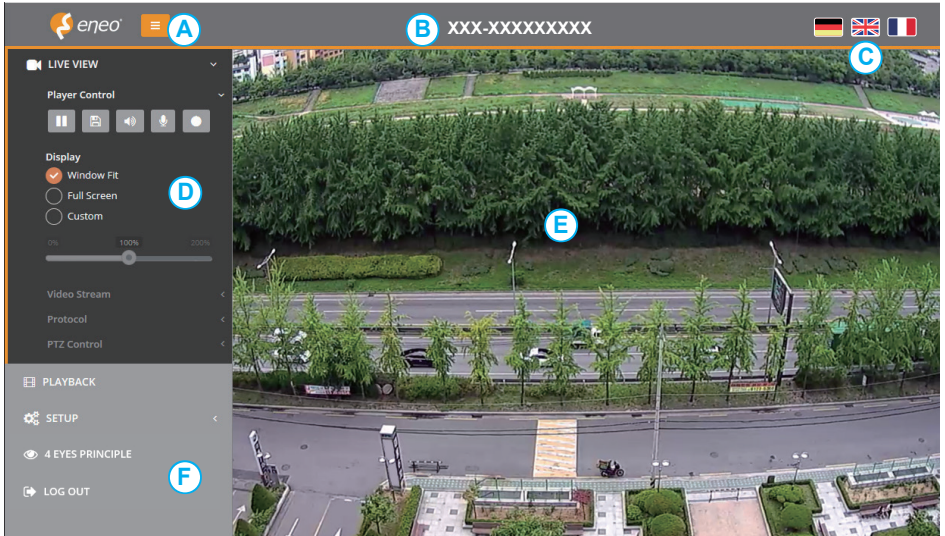

- A) Menu button : Click the button to show or hide the setup menu bar.
- B) Model name : Show a camera model name connected.
- C) Select Language : Set the web viewer language English, Deutsch or French.
- D) Main setup menu bar : Set the camera or network functions.
- E) Camera monitoring window: Display the currently connected camera view or function.
- F) Log out and exit the web viewer

■ Player Control

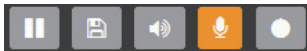

- ① Pause : Pauses the live view.
- ② Snapshot : Captures the image in .jpg format with the current stream resolution.
- ③ Speaker : Enables Audio to be output to the audio out port.

④ Microphone : Enables Audio to be input from the audio input port.

⑤ Record : Records the live video in H.264 format into the equipped storage memory like SD, SDHC & SDXC with the selected video stream at the RECORD menu.

Full Menu Setup

■ Display

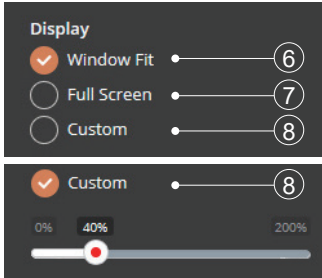

- ⑥ Window Fit : Resizes the live view display to fit along with the display window size.
- ⑦ Full Screen: Resizes the live view display to fit to the monitor resolution. ESC key returns to the previous view.
- ⑧ Custom : Selects the live view display scale, 0%~200%, by the control bar. 100% is original size.

■ Video Stream

Selects the video source stream to display the live view only.

■ Protocol

Selects the network protocol out of HTTPS, HTTP, TCP or UDP.

■ PTZ Control

Used to adjust zoom/focus manually or one-push focus automatically.

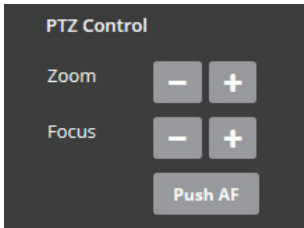

- ZOOM : Controls the lens optical zoom in/out for WIDE & TELE.
- FOCUS : Adjusts the lens focus manually for NEAR & FAR.
- PUSH AF : Gets the lens to focus at the push of a button.

CAUTION

- Do not adjust zoom/focus in low light conditions or night mode. It might cause erroneous focusing.

Full Menu Setup

2. PLAYBACK

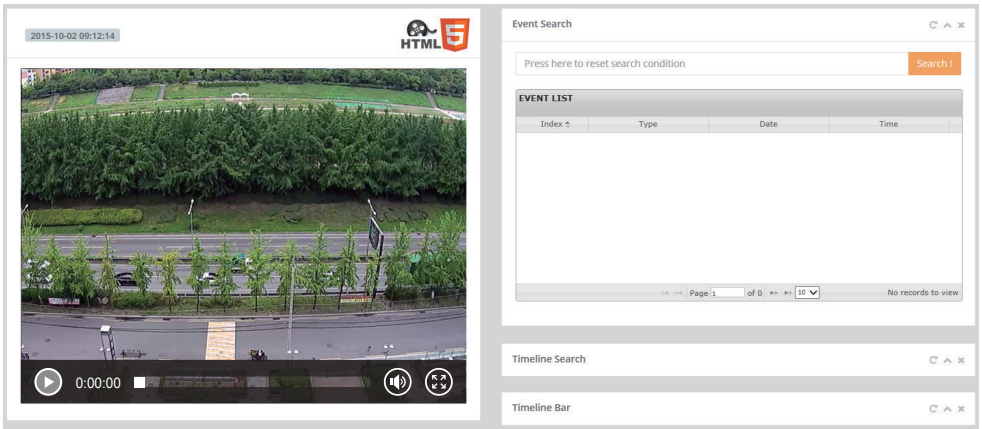

■ Event Search

Playback display using the event list.

- Press the input bar to pop up EVENT DATE & TIME window and select the event TYPE.
- Click SEARCH button to show up EVENT LIST.
- Select the recorded event and click the play button at the bottom-left corner of the playback window.

■ Timeline Search

Playback display by Date & Time for continuous and event recording.

- Select the date in the SEARCH CALENDAR and then the hour & minute at TIMELINE BAR.

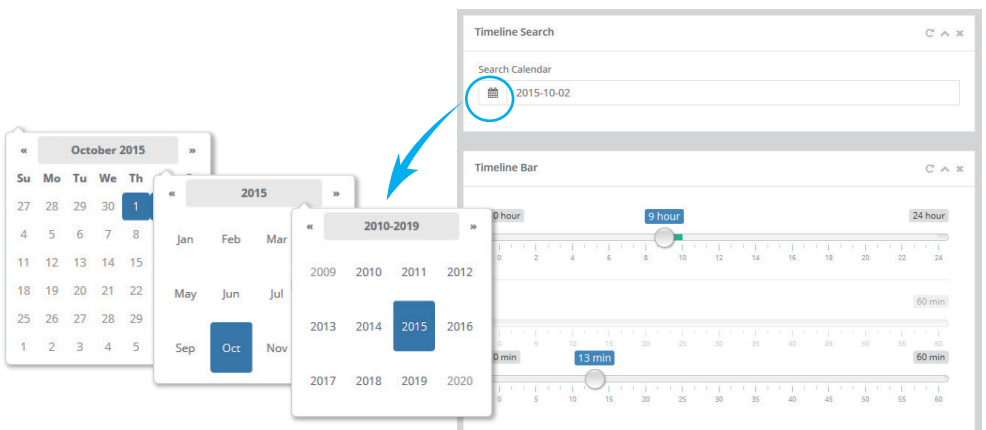

Full Menu Setup

3. SETUP

Enter the setup menu on the Web Viewer.

3-1. Information

Shows the overall information about the system such as Model name, MAC address, IP address, Zeroconf, IP address, Hardware version, Firmware version, Server time, Running time, CPU usage, Inbound/Outbound Bandwidth and Open source list.

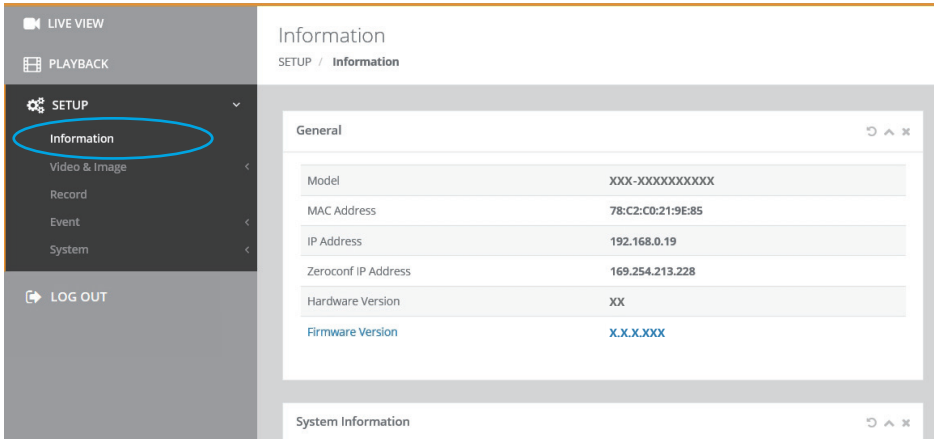

The screenshot shows the 'Information' setup page. The left sidebar has a 'SETUP' menu with 'Information' selected. The main content area is titled 'Information' and shows a 'General' section with the following data:

General	
Model	XXX-XXXXXXXXXX
MAC Address	78:C2:C0:21:9E:85
IP Address	192.168.0.19
Zeroconf IP Address	169.254.213.228
Hardware Version	XX
Firmware Version	X.X.X.XXX

Below the table is a 'System Information' section.

3-2. Video & Image

3-2-1. Source

- **SIGNAL** : Set NTSC/PAL mode depending on TV system. Generally set to NTSC in 60Hz area and PAL in 50Hz area for the electrical power system of your country. Changes will restart the camera.

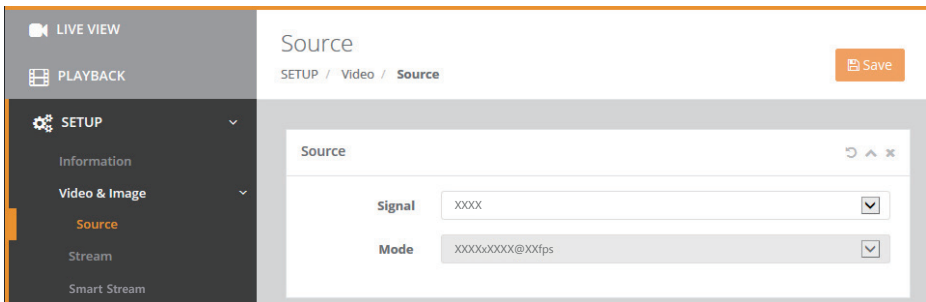

The screenshot shows the 'Source' setup page. The left sidebar has a 'SETUP' menu with 'Source' selected. The main content area is titled 'Source' and shows the following configuration fields:

Signal	XXXX	▼
Mode	XXXXXX@XXfps	▼

A 'Save' button is visible in the top right corner.

Full Menu Setup

3-2-2. Stream

Stream
Save

SETUP / Video / Stream

Stream1
↻ ^ x

Compression	H.264 High Profile	▼
Resolution	XXXXxXXXX	▼
Frame rate	30	▼
GOP size	30	▼
Bitrate control	VBR	▼
Bitrate [Kbps]	4000	▼
Bitrate quality	5	▼

• Stream1, 2, 3, 4

- > **COMPRESSION** : H.265(+) and H.264(+) are available in all stream but MJPEG is available in Stream 3, 4 only.
- H.265+, H.264+ : Enables to process video data smartly according to users demand and lowering overall bandwidth, and reduce the storage burden.
If H.265+ or H.264+ is selected, Smart Video Stream and Dynamic GOP are switched ON automatically.
Accordingly, ROI(Region of Interest) and Dynamic GOP should be set in Smart Video Stream menu to use H.265+ and H.264+.
- > **RESOLUTION** : Each stream can have its individual resolution selected from its list.
- > **FRAME RATE** : Each stream can have its individual frame rate in fps selected from its list.

Full Menu Setup

- > **GOP SIZE:** GOP (Group of Picture) defines the number of Intra-coded pictures (I frame) & Predictive-coded pictures(P frame) in H.264. I frame is a complete image while P frame is the predictive image data which can lower the image data dramatically between frames. GOP SIZE stands for the number of P frames between I frames. Too small GOP SIZE (too frequent I frames) can degrade the picture quality because the codec compresses the data strongly to maintain the bitrate. On the contrary, a little bigger GOP SIZE can improve the picture quality with the better quality for P frames if the network is in good condition. Too big GOP SIZE can make the longer black out or the broken image if the network quality is not good enough.
- > **BITRATE CONTROL :** Selects how to manage the bitrate.
 - **VBR (Variable Bit Rate):**
Provides the higher image quality with the optimal variable bitrate for the scene which has more moving elements in the image. It is not recommended when network is in heavy duty.
 - **CBR (Constant Bitrate) :**
Tends to keep the bitrate steady at the assigned bitrate within a very small variation. It is useful when the network is in very heavy use.
- > **BITRATE :** Indicates the transmission speed through the network and defines the overall picture quality along with the image resolution, frame rate, GOP size and the compression codec for H.265, H.264. A high value provides the higher image quality but the total sum of bitrates for the streams has to be considered in calculating the network duty.
- > **BITRATE Quality :** Enables to set the quality.

Full Menu Setup

3-2-3. Smart Video Stream

● **ROI(Region Of Interest)**

- > Enables to process video data smartly according to users demand.
- > Available to deliver high quality video on interested region while less quality video on non interested region.
- > Lowering overall bandwidth and reduce the storage burden.

> How to set Region of Interest:

- 1) Mark ENABLE checkbox to enable ROI function.
- 2) Click the mouse right button on the video viewer, select "Create ROI area" menu and Drag the ROI area.
- 3) After drag, enter a Name, select Quality and save.

ROI (Region Of Interest)
Dynamic GOP



Enable

Name

Quality

ID	Name	Quality	Delete

Enable non-ROI frame rate setting

Frame Rate

Stream	ROI frame rate	non ROI frame rate
1	25	<input type="text" value="10"/>
2	25	<input type="text" value="10"/>

Full Menu Setup

- 4) ROI frame rate is available to set in Settings> Video & Image> Video Stream.
- 5) To delete the selected area, Click the mouse right button on the video viewer, select "Create ROI area" or click "Delete" button.
- 6) After setting the mode, press the SAVE.

> How to set non Region of Interest:

Set the frame rate (non ROI frame rate) for each stream and press the SAVE.

● ***Dynamic GOP:***

- > Outputs Intra-coded pictures(I frame : Complete Image)
When there is motion or change in picture only to save bitrate.

Full Menu Setup

3-2-4. Image

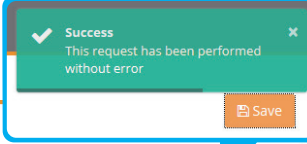
Success
 This request has been performed without error.

 Save

LIVE VIEW

PLAYBACK

SETUP

- Information
- Video & Image
- Source
- Stream
- Image
- Privacy Mask
- Digital Zoom
- Record
- Event
- System

Log out

Image

SETUP / Video / Image

Viewer



Save

Basic
OSD
AE
AWB
AF
Day/Night
WDR
BLC
DNR
LDC
VerticalView

Day

Brightness ▼

Contrast ▼

Saturation ▼

Night

Brightness ▼

Contrast ▼

Saturation ▼

Hue ▼

Sharpness ▼

Enable flip image
 Enable mirror image

Full Menu Setup

• Basic

- > BRIGHTNESS: Adjusts the overall brightness of the scene. Increasing the value increases the brightness.
- > CONTRAST: Adjusts the contrast of the scene. Increasing the value increases the contrast.
- > SATURATION: Adjusts the color richness of the scene. Increasing the value increases the color richness.
- > HUE: Adjusts the color hue (NTSC only). Decreasing the value produces a greenish hue and increasing the value produces a pinkish hue.
- > SHARPNESS: Adjusts the sharpness of the scene. Increasing the value increases the sharpness.
- > ENABLE FLIP IMAGE : Flips the image on horizontal axis (up and down).
- > EABLE MIRROR IMAGE : Mirrors the image on vertical axis (left and right).

• OSD

- > ENABLE TEXT OSD : Enables display of the Text typed in the TEXT field (displays bottom-right).
- > ENABLE DATE&TIME OSD : Enables display of the Date & Time (displays top-left).
- > ENABLE ZOOM&FOCUS OSD : Applies to Built-in Motor driven V/F lens or AF models only
Enables display of the Zoom Ratio & Focusing Mode (displays top-right).
- > MODE : Allows you to select when the ZOOM&FOCUS OSD is displayed.
 - ON PUSH: Displays on the OSD for a few seconds whilst lens is adjusting.
 - ALWAYS: Displays on the OSD at all times.

Basic
OSD
AE
AWB
AF
Day/Night
WDR
BLC
DNR
LDC
VerticalView

Enable text OSD

Text CAM1

Enable date&time OSD

Enable zoom&focus OSD

Mode On push ▼

Note

- The maximum length of OSD text is 16 characters.
- The available OSD characters are alphabet and numeric and +- = : ; , ' ? / ! ^ ~ ! @ # \$ * () [] < > { }

Full Menu Setup

• AE

- > MODE : Selects how to control the exposure, AUTOMATIC or MANUAL.
- > SLOW SHUTTER : Extends the shutter time over the maximum shutter at multiple times of value in SLOW SHUTTER. Increasing the values increases brightness but also increases blurriness(Available only with 2MP model)
- > LUMINANCE COMPENSATION : It compensates the brightness of video and adjusts brightness by weighting in automatic light intensity processing stage.
- > AUTO IRIS : Engages the mechanical iris of lens to control the amount of incoming light to the sensor.
 - OFF : Iris opens and the shutter is engaged to control the video level.
- > AUTO FLICKERLESS : Automatically detects and fixes the flickering image under fluorescent lighting caused by the mismatch between NTSC/PAL and 50Hz/60Hz electric power frequency.
- > SHUTTER : (Available only in MANUAL mode) Sets the shutter to a fixed value.
- > MAX. SHUTTER : (Available only in AUTOMATIC mode) Sets the maximum exposure time to limit long exposure at night or in low-light scenes.
- > GAIN : (Available only in MANUAL mode) Sets the overall video gain.
- > MAX. GAIN : (Available only in AUTOMATIC mode) Sets the maximum gain that can be automatically reached at night or in low-light scenes.

Basic	OSD	AE	AWB	AF	Day/Night	WDR	BLC	DNR	LDC	VerticalView	
		Mode	Automatic								▼
		Slow Shutter	2 [Default]								▼
		Luminance Compensation	5 [Default]								▼
		Auto Iris	Off								▼
		Auto Flicker-less	Off								▼
		Shutter [sec]	1/1000 [Default]								▼
		Max. Shutter [sec]	1/25 [Default]								▼
		Gain	10.0 [Default]								▼
		Max. Gain	50.0 [Default]								▼

Full Menu Setup

• AWB

- > **MODE** : Provides White Balance presets. ATW or Manual is recommended for most applications.
- > **R GAIN / Gr GAIN / Gb GAIN / B GAIN** : (Available only in MANUAL AWB mode)
Adjusts the white balance by Cb/Cr color components to the specific lighting which has a fixed color temperature. Not recommended for regular scenes.

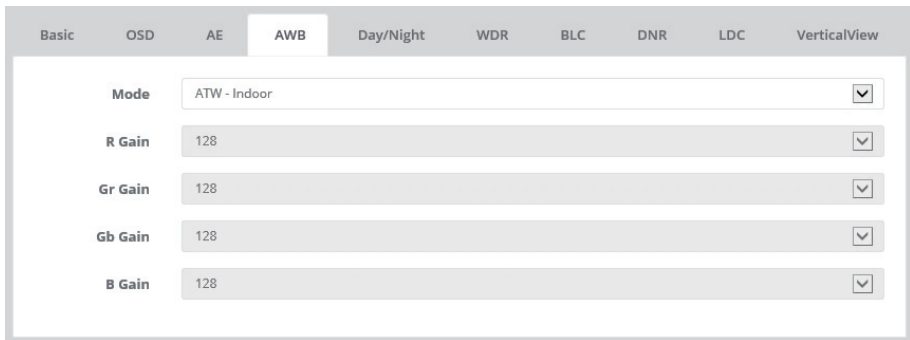

• AF

- > **MODE** : Selects how to control the focus of the built-in Motor driven V/F lens or AF lens.
 - **MANUAL** : Focusing works during zoom operation only and stops thereafter.
 - **AUTOMATIC** : Focusing works steadily for sharp focusing on the object. In the case of a Motor driven lens, focusing resumes in about 7~8 seconds to save the lens lifetime when the focus gets lost.
- [NOTE]**
 - 1) MANUAL mode is strongly recommended to maintain the working-life of the lens.
 - 2) Lens operation count is stored in the camera for service purposes.
- > **SPEED** : Adjusts the zoom control speed. Increasing the value increases the speed.
- > **LENS LOCKING** : Allows locking of the lens control to prevent undesirable operation.
 - **OFF** : Disables the locking feature allowing lens operation at any time.
 - **ON** : Locks and disables the lens operation immediately.
 - **TIMER** : Locks and disables the lens operation after a certain period of time, as set in LOCKING TIMER.
- > **LOCKING TIMER** : Defines the amount of time before the lens is locked.
- > **LENS CALIBRATION** : Calibrates and renews the lens data as setup at the Factory.

Full Menu Setup

The screenshot shows the 'AF' (Autofocus) menu in a camera's settings interface. The menu is divided into several tabs: Basic, OSD, AE, AWB, AF (selected), Day/Night, WDR, BLC, DNR, LDC, and VerticalView. The AF menu contains the following settings:

- Mode:** Manual (dropdown menu)
- Speed:** 3 (dropdown menu)
- Lens Locking:** Off (dropdown menu)
- Lens Calibration:** A section with a 'Start' button and two checkboxes:
 - Enable Day & Night sync focus
 - Lens initialize on boot

[WARNING]

LENS CALIBRATION is not necessary for regular installations.

LENS CALIBRATION would only be necessary should you not be able to focus the lens after a zoom operation due to shock during transportation of the camera.

To perform LENS CALIBRATION:

- A fixed object with sharp edges should be at least 3 meters away in front of the camera and should be stationary i.e. not moving. A plain wall is not suitable to calibrate on.
 - The camera must be placed firmly, without shock or vibration, during the calibration.
 - Scene light level must be bright enough. Do not try calibration at night or in low-light.
 - If the calibration fails, change the environment and try again.
- > **ENABLE DAY&NIGHT SYNC FOCUS** : Enables refocusing whenever the day&night changes. It is not recommended to use this feature as it may lose focus over the night due to focusing failure at night.
- > **LENS INITIALIZE ON BOOT** : Mark ENABLE checkbox to enable lens initializing when camera is booting.

Full Menu Setup

• Day & Night

- > MODE : Selects how to control the day/night feature.
 - DAY : Disables the switching day/night filter and fixes it to DAY only.
 - NIGHT : Disables the switching day/night filter and fixes it to NIGHT only.
 - AUTOMATIC : Allows the day/night filter to switch via the amount of the incoming light through the lens only. Cameras without the built-in IR LED must select AUTOMATIC.
 - EXTERNAL : Allows the day/night filter to switch via the built-in light sensor only, like a photo sensor. Cameras with the built-in IR LED must select EXTERNAL.
 - COLOR DN [AUTOMATIC] : Produces the color video at night without switching day/night filter. Values in BRIGHTNESS, CONTRAST&SATURATION at SETUP>VIDEO&IMAGE>IMAGE>BASIC>DAY or NIGHT are applied to the scenes for day and night accordingly.
- > SWITCHING TIME : Delays switching the day/night filter to prevent from an undesirable transition.
- > THRESHOLD [D->N] : (Available in AUTOMATIC mode)
Sets the threshold level for day->night switching. Decrease the value to switch at low luminance.
- > THRESHOLD [N->D] : (Available in AUTOMATIC mode)
Sets the threshold level for night->day switching. Increase the value to switch at high luminance.
- > THRESHOLD [Current] : (Available in AUTOMATIC mode)
Shows current threshold level.

Basic	OSD	AE	AWB	AF	Day/Night	WDR	BLC	DNR	LDC	VerticalView
					Mode					
					Switching Time [sec]					
					Threshold [Day->Night]					
					Threshold [Night->Day]					
					Threshold [Current]					

Full Menu Setup

[CAUTION]

- The gap between THRESHOLD [D->N] and THRESHOLD [N->D] should be greater than 18. Otherwise, an undesirable transition may occur.
- Too high a value in THRESHOLD [N->D] can cause cameras at installed in low-light areas to stay in night mode permanently i.e. even during daytime.

● **WDR** (DOL WDR : Digital Overlap Wide Dynamic Range)

- > WDR : Improves the visibility and the dynamic range for the high contrast scene temporarily with multi scan images
- > DWDR: Improves the visibility by compensating dark area spatially.
- > DEFOG: Enhances the image contrast against fog.

The screenshot shows the camera's settings menu with the 'WDR' tab selected. The menu is divided into three sections: WDR, DWDR, and Defog. Each section has a 'Mode' and a 'Level' dropdown menu.

Section	Mode	Level
WDR	Off	3
DWDR	On	1
Defog	Automatic	30

● **BLC**

The screenshot shows the camera's settings menu with the 'BLC' tab selected. The menu is divided into two sections: BLC and HLC. Each section has a 'Mode' and a 'Level' dropdown menu.

Section	Mode	Level
BLC	Off	Level3
HLC	On	

Full Menu Setup

- > BLC (Back Light Compensation) :
 - MODE : ON enhances the visibility of the back-lit object.
 - LEVEL : Determines the strength of the bright-up. High value gets brighter.
- > HLC (High Light Compensation) :
 - ON compensates whole image against High light area.

- **DNR** (Dynamic Digital Noise Reduction)

- > 3DNR :
 - MODE: ON reduces the noise by cancelling the spatial & temporal components in 3 dimensional a way.
 - LEVEL: Determines the strength of the noise reduction. Higher values reduce more noise but can also lead to a ghosting effect.

Basic	OSD	AE	AWB	Day/Night	WDR	BLC	DNR	LDC	VerticalView
<div style="border: 1px solid #ccc; padding: 10px;"> <p>3DNR</p> <p>Mode <input type="text" value="On"/> <input type="checkbox"/></p> <p>Level <input type="text" value="Level2"/> <input type="checkbox"/></p> </div>									

- **LDC** (Lens Distortion Compensation)

- > MODE : ON compensates for the barrel distortion caused by wide angles.
- > LEVEL : Determines the amount of the compensation. Higher values expand the shrunken areas in the corners.

Basic	OSD	AE	AWB	Day/Night	WDR	BLC	DNR	LDC	VerticalView
<div style="border: 1px solid #ccc; padding: 10px;"> <p>Mode <input type="text" value="On"/> <input type="checkbox"/></p> <p>Level <input type="text" value="35"/> <input type="checkbox"/></p> </div>									

Full Menu Setup

• *VerticalView*

- > MODE : ON displays the video in vertical view format, 16:9->9:16 for narrow streets, corridors or hallways.
- > ROTATION : Determines the orientation to rotate.

Viewer

Mode : On
Rotation : 90 degree

Basic OSD AE AWB Day/Night WDR BLC DNR LDC VerticalView

Mode Off

Rotation 90 degree

Note

- The VerticalView can be activated when Digital Zoom is off

Full Menu Setup

3-2-5. Privacy Mask

Mark ENABLE checkbox to activate the privacy masks.

- > COLOR : Select the color to mask at each privacy area.
- > NAME : Input the individual name for each privacy mask.

Privacy Mask

Color: Black

Name: New

ID	Name	Delete
1	New	Delete

Note

- The position of mask can be changed only if digital zoom and corridor function are inactive

To set the privacy mask (up to 8 privacy areas) :

- 1) Mark ENABLE checkbox.
- 2) In the video window, place the mouse cursor anywhere and click the right mouse button. A mini pop up appears.
Select CREATE MASK AREA / DELETE MASK AREA.
- 3) In the video window, place the mouse cursor where you would like to create a mask.
Click the left-mouse button to create (or delete) a mask. The mask window can be moved or resized with the mouse.
- 4) Enter the name in the list and then click SAVE.

Full Menu Setup

3-2-6. Digital Zoom

- > Mark ENABLE checkbox to activate the digital zoom.
- > LEVEL selects the fixed digital zoom ratio. X1.0 is not digital zoomed.

3-2-7. DIS (Digital Image Stabilization)

- > Mark ENABLE checkbox to reduce and stabilize the shaky image from a camera installed in the vibrating area. FOV(Field of view) will be reduced if set to ENABLE .

The screenshot shows the camera's web interface. On the left is a sidebar with 'LIVE VIEW' and 'SETUP' (with a gear icon). Under 'SETUP', there are several menu items: Information, Video & Image (expanded), Source, Stream, Nuevo Smart Video Stream, Image, Privacy Mask, Digital Zoom, DIS (highlighted in orange), Audio, Event, and System. At the bottom of the sidebar is a 'LOG OUT' button. The main content area is titled 'DIS' and shows the breadcrumb 'SETUP / Video & Image / DIS'. There is a 'Save' button in the top right. Below the breadcrumb is a video feed showing a road with trees. At the bottom of the video feed area is an 'Enable' checkbox, which is currently unchecked.

Full Menu Setup

3-3. Audio

- > Mark **ENABLE** checkbox to activate the audio. Supports full duplex audio.
- > **COMPRESSION** : Selects audio compression codec. μ -law is used primarily in North America and a-law used in most other countries outside North America. G.711 μ -law tends to give more resolution to higher range signals while G.711 a-law provides more quantization levels at lower signal levels.
- > **SAMPLE RATE** : Fixed at 8KHz by G.711.
- > **BITRATE** : Fixed at 64Kbps by G.711,the international standard for encoding wired-telephone audio.
- > Mark **INPUT MUTE** checkbox to mute the input from audio-in.

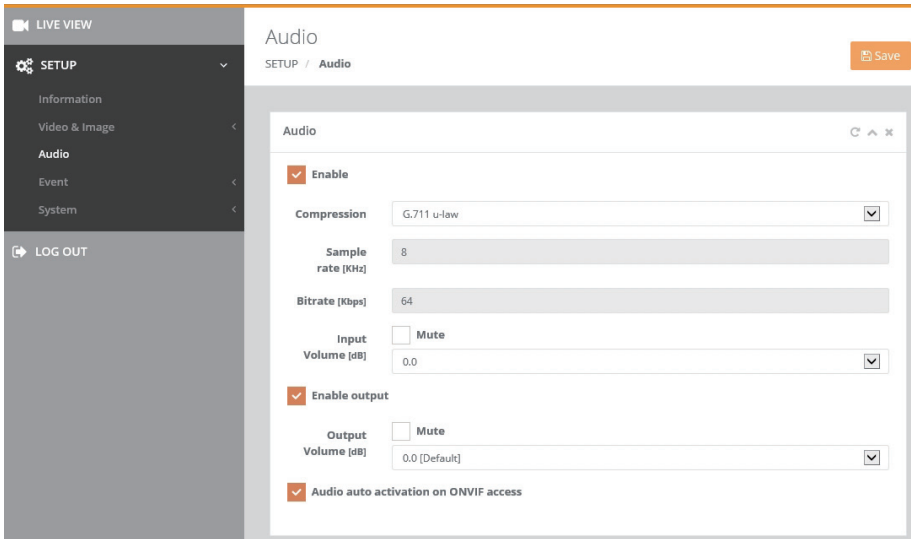

- > **INPUT VOLUME** : Adjusts the volume by the input signal level. -0.5dB reduces the volume about -6%, 0.0dB bypasses the signal without adjusting the volume and 3.0dB increases the volume about +41%.
- > Mark **ENABLE OUTPUT** checkbox to activate the audio. Supports full duplex audio.
- > Mark **OUTPUT MUTE** checkbox to mute the output to audio-out.
- > **OUTPUT VOLUME** : Adjusts the volume by the output signal level. -0.5dB reduces the volume about -6%, 0.0dB bypasses the signal without adjusting the volume and 3.0dB increases the volume about +41%.
- > **Audio auto activation on ONVIF access** If the checkbox is marked, Audio auto activation after reset or rebooting the camera is compatible to ONVIF.

Full Menu Setup

3-4. Record

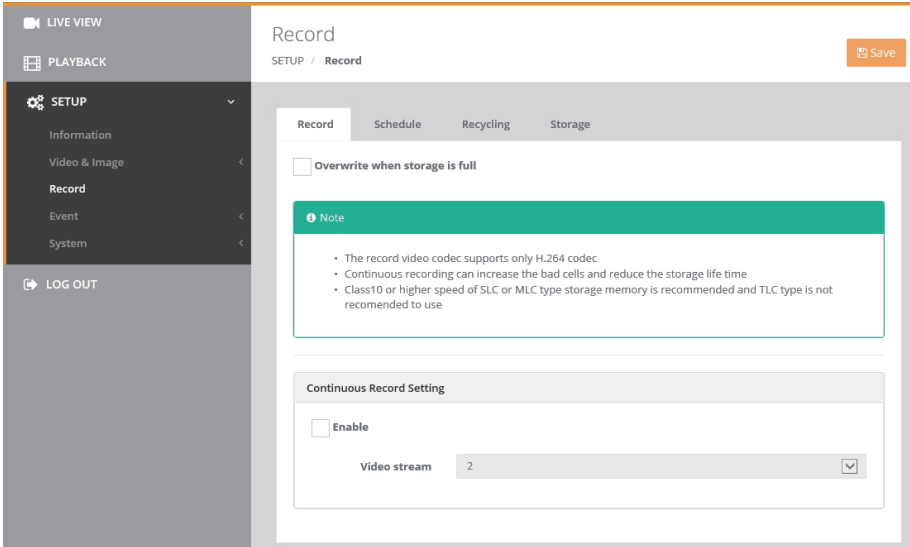

3-4-1. Record

- > Mark **OVERWRITE WHEN STORAGE IS FULL** checkbox to allow the storage to be overwritten.
 - > **CONTINUOUS RECORD SETTING** : Mark **ENABLE** checkbox to activate the continuous recording into the storage.
 - > **VIDEO STREAM** : Selects the stream to be recorded into the storage.
- [NOTE]** SD, SDHC or SDXC memory can be used as a storage device.
Refer to manual for the suitable memory size from standard SD or micro SD.

3-4-2. Schedule

- > Mark **ENABLE SCHEDULED RECORD** checkbox to activate the scheduled recording into the storage.
- > Mark each box in time and day matrix when to be recorded.
It can be selected a time zone or day of the week.

Full Menu Setup

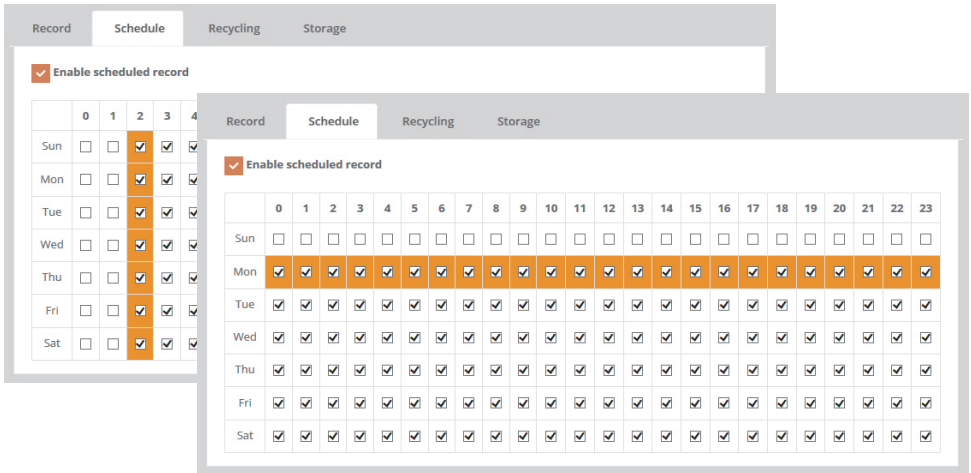

3-4-3. Recycling

- > Mark ENABLE RECYCLING checkbox to delete recorded video data in storage when certain time is passed. For example, if Recycling Time is set to 2 Months 1Day 0Hour, all the video data that passed 2 Months 1Day 0Hour will be deleted.
- > Recycling Time Setting : Set the storage period of recorded video data
 - Month : Set the Month of storage period from 0 to 12 Months.
 - Day : Set the Day of storage period from 0 to 30 days.
 - Hour : Set the Hour of storage period from 0 to 23 hours.

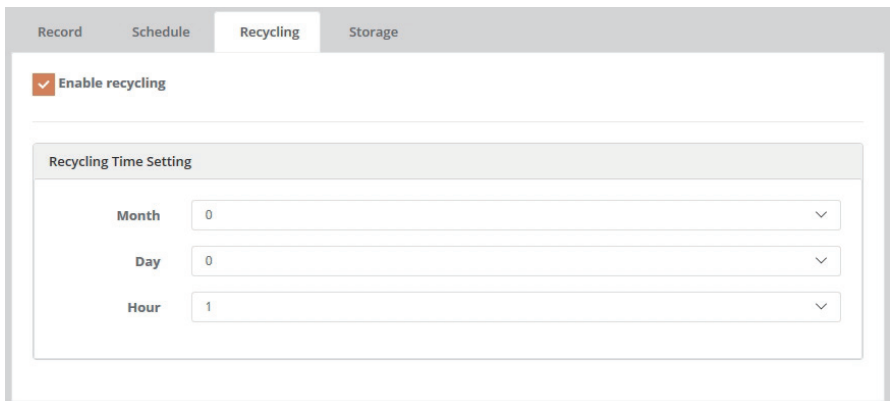

Full Menu Setup

3-4-4. Storage

- > **FORMAT** : Formats the storage. Backup the data before formatting the storage if necessary.
- > **REMOVE** : Helps removing the storage safely.

[NOTE]

Common Internet File System (CIFS) is a remote file access protocol that forms the basis for Windows file sharing, network printing, and various other network services. CIFS requires a large number of request/response transactions and its performance degrades significantly over high-latency WAN links such as the Internet. Network File System (NFS) is a network file system protocol, allowing a user on a client computer to access files over a network in a manner similar to how local storage is accessed. NFS, like many other protocols, builds on the Open Network Computing Remote Procedure Call (ONC RPC) system.

The screenshot shows a web interface for a network camera. At the top, there are four tabs: 'Record', 'Schedule', 'Recycling', and 'Storage'. The 'Storage' tab is selected. Below the tabs, there are two orange buttons: 'Format' and 'Remove'. The 'Format' button is followed by the text 'Format the storage.' and the 'Remove' button is followed by 'Remove and eject storage safely.'. Below this is a 'Storage Information' section. It shows 'Status' as 'Available' in a green box. Below that is a table with four columns: 'Total', 'Used', 'Available', and 'Used Percent'. The table contains the following data:

Total	Used	Available	Used Percent
7.41GB	7.19GB	222.55MB	97.07%

Full Menu Setup

3-5. Event

3-5-1. Triggers

EVENT TRIGGERS menu defines and sets the parameters for the various event sources.

[Important NOTE]

Once the event is generated, the camera can record the video into the storage, output the alarm signal, email the event, send the video clip to FTP, boost the video frame rate, move to PTZ preset or send the event to the notification server. These post processes require the settings at SETUP>EVENT>ACTIONS first and then SETUP>EVENT>RULES.

● **Motion :**

- > Mark ENABLE checkbox to create & activate up to 4 motion areas.
- > NAME : Input the individual name for each motion detection area.
- > SENSITIVITY: Sets the motion detection sensitivity for all areas. Higher values increase sensitivity
- > DWELL : Sets the time for the motion event once detected.

LIVE VIEW

SETUP

Information

Video & Image

Audio

Event

Triggers

Actions

Rules

System

LOG OUT

Triggers

SETUP / Event / Triggers Save

Motion
Alarm In
System
Manual
Network
Timer
Day/Night



Enable

Name:

Sensitivity: ▼

Dwell [sec]: ▼

ID	Name	Type	Dwell	Delete
1	default	Include	1	Delete

Full Menu Setup

To set the motion detection area (up to 4 include-types and 4 exclude-types) :

- 1) Mark ENABLE checkbox.
- 2) In the video window, place the mouse cursor where you would like to make a detection window and click&drag the right button. The following window is then generated.
 - INCLUDE-Type : defines areas where motion should be detected.
 - EXCLUDE-Type : defines areas within a window that should be ignored.
- 3) Enter a name and then click SAVE.

[NOTE]

Motion detection and VCA cannot be used simultaneously. If either one is enabled, the other one is disabled automatically.

• VCA (Video Contents Analysis)

Triggers

SETUP / Event / Triggers Save

Motion **VCA** Alarm In System Manual Network Timer Day/Night

OBJECT SETTING

Width :

Height :

Show object size

- Min. object size : 115 x 65 [px]
- Max. object size : 1152 x 648 [px]

Enable

Type

Name

Dwell time

ID	Name	Detector	Direction	Dwell	Delete

Full Menu Setup

- > Mark ENABLE checkbox to create & activate up to 3 VCAs(Line Cross, Field intrusion & Appear/Disappear)
- > NAME : Input the individual name for each VCA.
To set the VCA detection area (up to total 3 VCAs including Line Cross, Field intrusion & Appear/Disappear):
 - 1) Mark ENABLE checkbox.
 - 2) Click the mouse right button on the video viewer and a popup menu appears.
 - CREATE VCA DETECTOR : Select to create the VCA type, up to 3 VCAs.
 - CREATE MASKING AREA : Select to create the masking area which will exclude the detection.
 - DELETE VCA DETECTOR : Deletes the existing VCA window. VCAs can be deleted at the list too.
 - DELETE MASKING AREA : Deletes the existing VCA mask window.
 - 3) Enter a name and then click SAVE.

[NOTE] Motion detection and VCA cannot be used simultaneously.
If either one is enabled, the other one is disabled automatically.

> OBJECT SETTING:

Click the green rotating icon on the top-right of the video window and OBJECT SETTING menu will appear. To hide it, click the icon again.

Mark SHOW OBJECT SIZE checkbox and a black rectangle at the top-left corner of the video window will appear. The black rectangle is the reference size which shows the minimum (white box) & maximum (black box) detecting size of the object. To adjust the minimum (or maximum) object size to be detected, adjust the left (right) ends of the slide bars, WIDTH & HEIGHT, by moving them with clicking and holding the left mouse button. Objects can be detected only for the object size set between minimum and maximum, that is, an object which is smaller than minimum or greater than maximum can't be detected. Too small value in MINIMUM or too big value in MAXIMUM for the object size might increase the erroneous detections.

- WIDTH : Sets the minimum/maximum sizes in width of the objects to be detected.
- HEIGHT : Sets the minimum/maximum size in height of the objects to be detected.
- SHOW OBJECT SIZE : Shows the reference size of detection object.

Full Menu Setup

• Alarm In

- > Mark ENABLE checkbox to input the alarm signal from the alarm-in port.
- > TYPE : Lets the camera know the type of alarm contacts, NO=Normally Open & NC=Normally Close.
- > DWELL TIME : Sets the time for the alarm once detected by the alarm-in.

The screenshot shows the 'Alarm In' configuration menu. At the top, there are tabs for 'Motion', 'Alarm In', 'System', 'Manual', 'Network', 'Timer', and 'Day/Night'. The 'Alarm In' tab is selected. Below the tabs, there is a section with an 'Enable' checkbox that is checked. Underneath, there is a 'Type' dropdown menu set to 'NO' and a 'Dwell time [sec]' input field set to '5'.

• System

Used to trigger the event when the camera gets rebooted.

- > Mark ENABLE checkbox to activate the system event.
- > DWELL TIME : Sets the time for the alarm once the system event is detected.

The screenshot shows the 'System' configuration menu. At the top, there are tabs for 'Motion', 'Alarm In', 'System', 'Manual', 'Network', 'Timer', and 'Day/Night'. The 'System' tab is selected. Below the tabs, there is a section with an 'Enable' checkbox that is unchecked. Underneath, there is a 'Dwell time [sec]' input field set to '3'.

Full Menu Setup

• **Manual :**

Enables to user to set the event trigger optionally.

- > Mark ENABLE checkbox to enable the manual trigger icons on the live view menu.
- > DWELL TIME : Sets the time for the event once triggered by the manual trigger on the live view menu.

The screenshot displays the 'Manual' configuration menu. At the top, there is a navigation bar with tabs for Motion, Alarm In, System, Manual (selected), Network, Timer, and Day/Night. Below the navigation bar, there are four identical sections for Manual Trigger1, Manual Trigger2, Manual Trigger3, and Manual Trigger4. Each section contains an 'Enable' checkbox (currently unchecked) and a 'Dwell time [sec]' dropdown menu (currently set to 3).

Full Menu Setup

• **Network :**

Used to trigger the event when the network connection fails.

> Mark ENABLE checkbox to activate the network event.

> DWELL TIME : Sets the time for the event once triggered by the network connection event.

Motion VCA Tamper System Manual **Network** Timer Day/Night

Enable

Dwell time [sec] 3

• **Timer**

Mark ENABLE checkbox to trigger the event as defined Timer Interval.

(Hour/Minute/Second)

Motion VCA Tamper System Manual Network **Timer** Day/Night

Enable

Timer Interval

Hour 1

Minute 0

Second 0

• **Day / Night**

Mark ENABLE checkbox to trigger the event when Day/Night is switched.

> MODE : Select the mode, Day->Night or Night->Day.

> DWELL TIME : Sets the interval duration for the alarm event.

Motion VCA Tamper System Manual Network Timer **Day/Night**

Enable

Mode Day -> Night

Dwell time [sec] 3

Full Menu Setup

• **Audio Detect**

Mark ENABLE checkbox to detect Audio.

> Dwell time(sec) : Sets the dwell time(1~180 sec) for Audio detection.

> Volume Threshold : Sets the volume threshold value(1~100).

Below setting is necessary to integrate Audio detection and Alarm out.

1) Enable Audio Detect (Dwell time and Volume Threshold value should be adjusted according to the circumstance of site.)

Motion Alarm In System Manual Network Timer Day/Night **Audio Detect**

Enable

Dwell time [sec] 3

Volume Threshold 50

2) SETUP > Event > Triggers > Alarm IN

Make sure if Alarm IN is enabled. Alarm Type should be set to “NO” and dwell time should be 1 sec.

Motion **Alarm In** System Manual Network Timer Day/Night Audio Detect

Enable

Type NO

Dwell time [sec] 1

Full Menu Setup

3) SETUP > Event > Rules > Add

> Add Event rule as below.

Event type: Audio_Detect

Event Action: Alarm out

Add Rule ✕

Name

Event Trigger

Type

→ Event type - Audio_Detect

Event Action

Alarm out

→ Event Action - Alarm out

> Check if Event rule is normally added.

Rules

SETUP / Event / **Rules**

Event Processing ONVIF Mapping

#	Name	Trigger	Action
1	New Rule	Audio_Detect	AlarmOut1

Full Menu Setup

3-5-2. Actions

EVENT ACTIONS menu defines and sets the parameters for how to treat the various event sources.

The screenshot shows the 'Actions' configuration page. The left sidebar is expanded to 'SETUP' and 'Actions' is selected. The main content area has tabs for 'Record', 'E-Mail', 'FTP', 'Video Boost', and 'Notification Server'. The 'Record' tab is active, displaying the following settings:

- Enable
- Video stream: 1
- Recording time[sec]: 60
- Pre recording time[sec]: 0

A note box contains the text: "The record video codec supports only H.264 codec".

● **Record**

- > Mark ENABLE checkbox to enable recording into the built-in storage when the event occurs.
- > VIDEO STREAM : Selects the stream to be recorded when the event occurs.
- > RECORDING TIME : Sets the length of time to record after the event.
- > PRERECORDING TIME : Sets the length of time to record before the event.

● **Alarm Out**

- > Mark ENABLE checkbox to output the alarm signal to the alarm-out port.
- > TYPE : Selects the type of alarm contacts, NO=Normally Open & NC=Normally Closed. Alarm-out port is not an actual relay contact but outputs 0V for Low level & 3.3V for High level with the current driving capacity of 50mA max.

The screenshot shows the 'Alarm Out' configuration page. The left sidebar is expanded to 'SETUP' and 'Alarm Out' is selected. The main content area has tabs for 'Record', 'Alarm Out', 'E-Mail', 'FTP', 'Video Boost', and 'Notification Server'. The 'Alarm Out' tab is active, displaying the following settings:

- Enable
- Type: NO

Full Menu Setup

• *E-mail*

The camera can send email messages generated by the events via SMTP (Simple Mail Transfer Protocol).

- > Mark ENABLE checkbox to enable emailing.
 - SENDER : Enter the email address as the sender. Any virtual email address like sample@sample.com can be used if the recipient can recognize it from the camera.
 - INTERVAL : Sets the interval for emailing after the events occur.
 - AGGREGATE EVENTS : Sets the number of events which will be sent in an email.
- > Mark USE MAIL SERVER checkbox to set the mailing server.
 - MAIL SERVER : Enter the host name or IP addresses for the mail servers. If a host name is used, a valid DNS server must be specified in the Network-Basic settings.
 - PORT : Enter the port number of the mail server.
- > Mark ENABLE USE(SMTP) AUTHENTICATION checkbox if the mail server requires authentication.
 - USER NAME : Enter the user name as provided by the network administrator.
 - PASSWORD : Enter the password as provided by the network administrator.
 - LOGIN METHOD : Select one for SMTP authentication method allowed.

[NOTE]

If a PLAIN or LOGIN mechanism is negotiated, the camera sends the user name and password to the SMTP server. The LOGIN mechanism is supported by Microsoft, as well as some other clients. Most other clients support the PLAIN authentication mechanism. Since the vast majority of Email clients support only PLAIN or LOGIN, mail server administrators will probably want to consider using STARTTLS to provide an encryption "tunnel" between the client and server to protect the user name and password.

- > RECEIVER LIST : Enter the recipient's email addresses as the receivers.
- > E-MAIL(SMTP) TEST : Enter the recipient's email address in RECEIVER and click the TEST button to test if the mail servers are functioning and the email address is valid.

Full Menu Setup

Alarm Out
E-Mail
FTP
Video Boost
Notification Server

Enable

Sender

Interval [1... 86400] sec

Aggregate events [1... 100] EA

Use mail server

Mail server

Port

Enable use(SMTP) authentication

User name

Password

Login method

Secure connection

Receiver List

Receiver1 <input style="width: 100%;" type="text"/>	Receiver2 <input style="width: 100%;" type="text"/>
Receiver3 <input style="width: 100%;" type="text"/>	Receiver4 <input style="width: 100%;" type="text"/>
Receiver5 <input style="width: 100%;" type="text"/>	Receiver6 <input style="width: 100%;" type="text"/>
Receiver7 <input style="width: 100%;" type="text"/>	Receiver8 <input style="width: 100%;" type="text"/>

E-Mail(SMTP) Test

Receiver

Full Menu Setup

• FTP

FTP notification will save files on the specified FTP server.

> Mark ENABLE checkbox to set the FTP server.

- **SERVER** : Enter the IP address or host name of the specific FTP server.
- **PASSIVE MODE** : Under normal circumstances the network camera simply requests the target FTP server to open the data connection. Checking this box issues a PASV command to the FTP server and establishes a passive FTP connection; whereby the network camera actively initiates both the FTP control and data connections to the target server. This is normally desirable if there is a firewall between the network camera and the target FTP server.
- **PORT** : Enter the port number used by the FTP server. The port number can be adjusted in the range 1-65535. The default setting is 21.
- **REMOTE DIRECTORY**: Specify the path to the directory where the uploaded images will be stored. If this directory doesn't already exist on the FTP server, an error message shows up when uploading.
- **USER NAME**: Enter the user name provided by the network administrator.
- **ANONYMOUS LOGIN**: Mark ANONYMOUS LOGIN checkbox if anyone is permitted to access the FTP server.
- **PASSWORD**: Enter the password provided by the network administrator.

Record
E-Mail
FTP
Video Boost
Notification Server

Enable

Server

Port

Remote directory

User name

Password

Passive mode

Anonymous login

JPEG Setting

Pre-event [sec] [fps]

Post-event [sec] [fps]

Prefix file name

Additional suffix None Date&Time Sequence number

Full Menu Setup

> JPEG SETTING : Configures JPEG for the FTP server.

- PRE-EVENT : Sets the time & the frame rate for JPEG images to be sent to FTP before the event.
- POST-EVENT : Sets the time & the frame rate for JPEG images to be sent to FTP after the event.
- PREFIX FILE NAME : Input the prefix for JPEG image file names to be sent to FTP.
- ADDITIONAL SUFFIX : Selects the suffix for JPEG image file names to be added after the file name. Selecting NONE will overwrite the previous file and thus DATE & TIME is most preferable.

• Video Boost

Sets the frame rate and bitrate for H.264 stream and the quality for JPEG stream at EVENT STATE when the event occurs.

[NOTE] Video boost is disabled during SD recording.

Alarm Out	E-Mail	FTP	Video Boost	Notification Server
Video Boost 1				
<input type="checkbox"/> Enable				
	Normal State		Event State	
Frame rate	28		30 <input type="button" value="v"/>	
Bitrate	2500		2500 <input type="button" value="v"/>	
Video Boost 2				
<input type="checkbox"/> Enable				
	Normal State		Event State	
Frame rate	30		30 <input type="button" value="v"/>	
Bitrate	1000		1000 <input type="button" value="v"/>	
Video Boost 3				
<input type="checkbox"/> Enable				

Full Menu Setup

• Notification Server

- > Mark ENABLE checkbox to notify the event to the notification server when it occurs.
 - TYPE : Selects the network protocol to connect the notification server.
 - SERVER URL : Input the server URL of the notification sever. To enable the audio when the event occurs, copy the URL at SETUP>AUDIO and paste it on the server URL like `http://x.x.x.x/setup/audio/audio.php`
 - USERNAME : Enter the username (default : admin)
 - PASSWORD : Enter the password (default : admin)
- > NOTIFICATION TEST: Input the test message and click TEST button.

[NOTE]

There could be several event actions like FTP, e-mail etc. For detailed URL per event actions, refer to API documents. In case Notification server is set as event rule, the same URL from Notification Test should be entered in RULE>ADD>NOTIFICATION SERVER.

The screenshot shows a web interface for configuring a Notification Server. At the top, there are tabs for 'Record', 'E-Mail', 'FTP', 'Video Boost', and 'Notification Server'. The 'Notification Server' tab is active. Below the tabs, there is a section for enabling the notification server. An 'Enable' checkbox is checked. Below this, there are four input fields: 'Type' (a dropdown menu set to 'HTTP'), 'Server URL' (a text box containing 'http://'), 'Username' (an empty text box), and 'Password' (an empty text box). Below these fields is a 'Notification Test' section. It contains a 'Message' text box and a 'Test' button.

Full Menu Setup

3-5-3. Rules

EVENT RULES menu defines and sets the parameters for what to do for the various event sources.

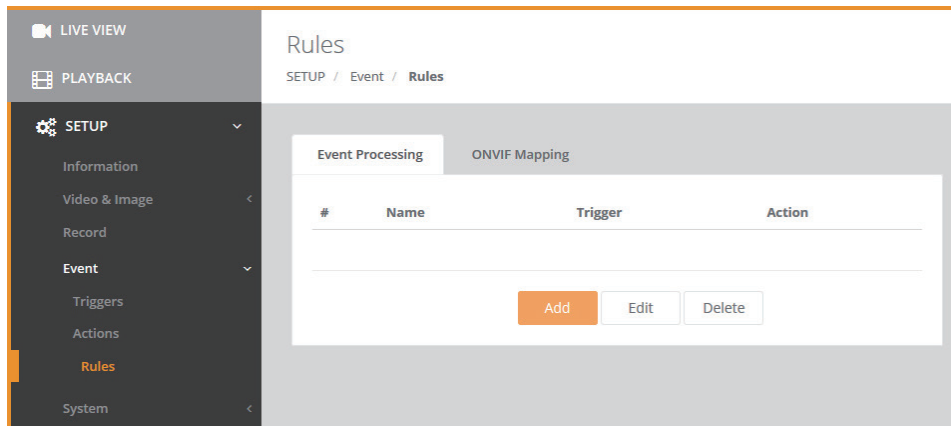

• **Event Processing**

Event process lists have to be generated and can be edited for what to do when the event occurs. List shows the rule name, trigger source and type of action for each event process. To edit or delete the rule in the list, click the listed line and then click EDIT or DELETE button.

ADDing & EDITing RULES

> NAME : Input the rule name which is descriptive to the rule.

EVENT TRIGGER

> TYPE : Select the type of the event trigger source.

EVENT ACTION

> E-MAIL :

- Input the email addresses to be emailed.
- Mark the checkbox for the email addresses to be emailed as set in SETUP>EVENT> ACTIONS>E-MAIL when the selected event occurs
- SUBJECT of email is a required field and ADDITIONAL INFO is optional to input.

> NOTIFICATION SERVER: Mark the checkbox to use the notification server as set in SETUP>EVENT> ACTIONS> NOTIFICATION SERVER when the selected event occurs.

- MESSAGE : Input the message to be sent to the notification server.

Full Menu Setup

- > FTP : Mark the checkbox to use FTP as set in SETUP>EVENT>ACTIONS>FTP when the selected event occurs.
- > VIDEO BOOST : Select the video stream to be boosted up.
[NOTE] Video boost is disabled if RECORD is enabled.
- > RECORD : Mark the checkbox to record the image into the built-in storage, if available, as set in SETUP>EVENT>ACTIONS>RECORD when the selected event occurs.

Add Rule ✕

Name

Event Trigger

Type **AND**

Event Action

Alarm out

E-Mail

Address1 Address2

Address3 Address4

Address5 Address6

Address7 Address8

Subject

Additional info

Notification Server

Message

FTP

Video Boost Video1 Video2 Video3 Video4

Record

Full Menu Setup

• ONVIF Mapping

Onvif mapping is provided to map the various events generated by this camera, but not defined by Onvif, to assign them to Onvif events for the Onvif compatible VMSeS or NVRs. Two mappings for Motion and Alarm In are provided to be mapped and can be used by editing them.

For example, any of the selected items in tns1:VideoSource/MotionAlarm will notify the Onvif compatible VMSeS or NVRs as Motion Alarm. In the same way, any of the selected items in tns1: Device/Trigger/Digital Input will notify the Onvif compatible VMSeS or NVRs as Alarm IN.

Event Processing		ONVIF Mapping	
#	Event Topic	Event Notification	
1	tns1:VideoSource/MotionAlarm	Motion Detection	<input type="button" value="Edit"/>
2	tns1:Device/Trigger/DigitalInput	Network Loss	<input type="button" value="Edit"/>

> Select which type of event notifications you want to send as motion alarm via ONVIF.
Event Notification: Motion Detection, VCA, Alarm IN, System Booting, Network loss, Manual Trigger, Timer, Day&Night

Full Menu Setup

3-6. System

3-6-1. Security

• Users

Manages the user accounts by names, groups and authorities.

> USERS : Can be added, edited or deleted.

The screenshot shows the 'Security' management page. The breadcrumb is 'SETUP / System / Security'. The 'Users' tab is selected, showing a table with the following data:

#	Name	Group	Authority
1	admin	administrator	live, setup, system

Buttons for 'Add', 'Edit', and 'Delete' are located below the table.

The 'Add User' dialog box contains the following fields and options:

- Name:
- Password:
- Confirm Password:
- Group: (dropdown menu)
- ptz
- playback

Buttons:

The 'Edit User' dialog box contains the following fields and options:

- Name:
- Password:
- Confirm Password:
- Group: (dropdown menu)

Buttons:

Full Menu Setup

• HTTPS

Selects the CONNECTION MODE.

The screenshot shows the 'HTTPS' configuration page. At the top, there are tabs for 'Users', 'HTTPS', 'IP Filter', 'ONVIF', 'Video Stream', and 'Export / Import'. The 'HTTPS' tab is active. Below the tabs, there is a 'Connection mode' dropdown menu currently set to 'HTTP&HTTPS'. Below that, there is a checkbox labeled 'Redirect HTTP to HTTPS' which is checked.

- > HTTP : Transfers data without encryption. Supports a URL that only starts with "HTTP: "
- > HTTPS : Transfer data with encryption by Hypertext Transfer Protocol over SSL protocol. Supports a URL that only starts with "HTTPS: "
- > HTTP&HTTPS : Supports both HTTP and HTTPS protocols.
- > Redirect HTTP to HTTPS : Enables to redirect HTTP to HTTPS.

[NOTE]

To ensure security on the internet, all web browsers provide several security levels that can be adjusted for sites that use SSL (Secure Socket Layer) technology to transfer data. SSL encrypts communications, making it difficult for unauthorized users to intercept and view user names and passwords. SSL requires signed certificates to determine if the web browser accessing the camera has the required authentication. This camera can generate a self-signed certificate using Open SSL.

• IP Filter

- > Mark ENABLE IP ADDRESS FILTERING to filter the IP addresses.
- > Mark ON/OFF for the IP address range to use IP filtering.
- > Select ALLOW or DENY to permit or filter out the IP address range.
- > Input the IP address ranges with START IP and END IP.

The screenshot shows the 'IP Filter' configuration page. At the top, there are tabs for 'Users', 'HTTPS', 'IP Filter', 'ONVIF', 'Video Stream', and 'Export / Import'. The 'IP Filter' tab is active. Below the tabs, there is a checkbox labeled 'Enable IP address filtering' which is unchecked. Below that is a table with 5 rows for IP filtering rules. Each row has columns for 'On/Off', 'Priority', 'Policy', 'Start IP', and 'End IP'.

On/Off	Priority	Policy	Start IP	End IP
<input type="checkbox"/>	1	ALLOW <input type="checkbox"/>	0 . 0 . 0 . 0	0 . 0 . 0 . 0
<input type="checkbox"/>	2	ALLOW <input type="checkbox"/>	0 . 0 . 0 . 0	0 . 0 . 0 . 0
<input type="checkbox"/>	3	ALLOW <input type="checkbox"/>	0 . 0 . 0 . 0	0 . 0 . 0 . 0
<input type="checkbox"/>	4	ALLOW <input type="checkbox"/>	0 . 0 . 0 . 0	0 . 0 . 0 . 0
<input type="checkbox"/>	5	ALLOW <input type="checkbox"/>	0 . 0 . 0 . 0	0 . 0 . 0 . 0

Full Menu Setup

[NOTE] To add a subnet of network addresses, these must be added in CIDR (Classless Inter-Domain Routing) notation. For example: entering 192.168.1.0/24 will add all the addresses in the range 192.168.1.1 to 192.168.1.254. Contact your network administrator for more detail. If the network camera is accessed via a proxy server, the IP address for the proxy server must be added as an allowed address.

● ONVIF

> Mark ENABLE WS SECURITY to provide the ONVIF compliance.

● Video Stream

- > ENABLE RTSP AUTHORIZATION : If marked, the authorization is required when the RTSP is requested.
- > ENABLE JPEG SNAPSHOT AUTHORIZATION : If marked, the authorization is required when the Jpeg snapshot image is requested.
- > ENABLE JPEG/HTTP PUSH AUTHORIZATION : If marked, the authorization is required when the Jpeg/HTTP PUSH image is requested.

The screenshot shows the 'Video Stream' configuration menu. At the top, there are tabs for 'Users', 'HTTPS', 'IP Filter', 'ONVIF', 'Video Stream', and 'Export / Import'. The 'Video Stream' tab is selected. Below the tabs, there are three checkboxes, all of which are unchecked:

- Enable RTSP authorization
- Enable JPEG Snapshot authorization
- Enable JPEG/HTTP PUSH authorization

● Export / Import

> Mark ENABLE ENCRPTION FOR EXPORT AND IMPORT FILE :
System configuration file, which is exported at SETUP>SYSTEM>MAINTENANCE>SETUP EXPORT, is encrypted with the password herein.

[NOTE] THIS PASSWORD MUST BE USED when System configuration file is imported by other cameras if the file was exported with the password.

> If the checkbox is not marked, system configuration file is exported without encryption.

The screenshot shows the 'Export / Import' configuration menu. At the top, there are tabs for 'Users', 'HTTPS', 'IP Filter', 'ONVIF', 'Video Stream', and 'Export / Import'. The 'Export / Import' tab is selected. Below the tabs, there is a checkbox labeled 'Enable encryption for Export and Import file' which is checked. Below this checkbox are two password input fields:

- Password:
- Confirm Password:

Full Menu Setup

3-6-2. Date & Time

• **Current Time**

Shows the current date and time. Clicking SAVE tap updates and saves the date and time with the selected time in NEW TIME.

• **New Time**

Select one of the following server times.

> SYNCHRONIZE WITH COMPUTER TIME : Obtains the time from the computer.

> SET MANUALLY : Sets the date and time manually.

> SYNCHRONIZE WITH NTP SERVER : Obtains the time from the assigned NTP server at every hour in INTERVAL. The NTP server's IP address or host name has to be specified in the time server.

• **Time Zone**

Select the time zone to be referenced to the NTP server where the camera is installed. Mark AUTOMATICALLY ADJUST FOR DAYLIGHT SAVING CHANGES check box to update the time automatically with daylight savings.

• **Date & Time Display**

Select the date & time formats to be displayed.

The screenshot displays the 'Date & Time' configuration page. On the left is a navigation menu with 'LIVE VIEW', 'PLAYBACK', 'SETUP', and 'LOG OUT'. The 'SETUP' menu is expanded to show 'Date & Time' selected. The main content area is titled 'Date & Time' and includes a 'Save' button. It is divided into three sections: 'Current Time' (showing Date: 01-01-1970, Time: 23:57:25), 'New Time' (with 'Synchronize with computer time' selected, Date: 13-01-2016, Time: 17:04:23; 'Set manually' with Date: 01-01-1970, Time: 23:57:10; and 'Synchronize with NTP server' with Server: 0.pool.ntp.org, Interval: 12 hours), and 'Time Zone'.

Full Menu Setup

3-6-3. Network

• TCP/IP

> IPv4 ADDRESS :

- **OBTAIN IP ADDRESS VIA DHCP** : Gets the IP address assigned by the DHCP (Dynamic Host Configuration Protocol) server.
- **STATUS** : 'Allocated' shows that the IP address is obtained from the DHCP.
- **IP ADDRESS, SUBNET MASK, GATEWAY** : Displays the current IP address which is obtained from the DHCP.
- **USE THE FOLLOWING ADDRESS** : Requires the input of a static IP address manually.

> IPv6 ADDRESS : Mark ENABLE check box to use IPv6 address and click SAVE button, then new IPv6 address will be obtained.

> DNS :

- **OBTAIN DNS ADDRESS VIA DHCP SERVER** : Obtains the DNS address automatically assigned by DHCP server.
- **USE THE FOLLOWING DNS ADDRESS** : Requires manual input as per below.
 - **DOMAIN NAME** : Enter the domain for the host name
 - **PRIMARY DNS SERVER** : Enter the IP address of the primary DNS server.
 - **SECONDARY DNS SERVER** : Enter the IP address of the secondary DNS server.

> HOSTNAME : This camera can be accessed using a host name instead of an IP address. The host name is usually the same as the assigned DNS name.

The screenshot displays the 'Network' setup page in a web interface. The left sidebar shows navigation options: LIVE VIEW, PLAYBACK, and SETUP (expanded). Under SETUP, 'System' is selected, and 'Network' is highlighted. The main content area is titled 'Network' and includes a breadcrumb trail 'SETUP / System / Network' and a 'Save' button. Below the title, there are tabs for 'TCP/IP', 'DDNS', 'RTP', 'UPnP', 'Zeroconf', and 'Bonjour'. The 'TCP/IP' tab is active, showing the 'IPv4 Address' configuration. The 'Obtain IP address via DHCP server' option is selected with a checked radio button. The 'Status' is 'Allocated'. The 'IP address' is 192.168.0.87, the 'Subnet mask' is 255.255.255.0, and the 'Gateway' is 192.168.0.1. There is also an unselected radio button for 'Use the following IP address'.

Full Menu Setup

IPv6 Address	
<input type="checkbox"/> Enable	
IPv6 address	fe80::211:22fffe33:4455/64
DNS	
<input checked="" type="radio"/> Obtain DNS address via DHCP server	
<input type="radio"/> Use the following DNS address	
Domain name	
Primary DNS	168 . 126 . 63 . 1
Secondary DNS	0 . 0 . 0 . 0
Hostname	
Hostname	RWS-H4MIPAF39-IR001122334455
Port	
HTTP port	80
HTTPS port	443
RTSP port	554
Ethernet Property	
Speed & Duplex	Auto <input type="checkbox"/>

Full Menu Setup

> PORT :

- HTTP PORT : Use a port number in the range 1024-65535. Default is 80.
- HTTPS PORT : Use a port number in the range 1024-65535. Default is 443.
- RTSP PORT : Use a port number in the range 1024-65535. Default is 554.

> Ethernet Property : Enable to set speed and duplex.

● **DDNS** (Dynamic Domain Naming Service)

> Mark ENABLE checkbox to use DDNS.

> DDNS server : Select the DDNS server to use.

> Input REGISTERED HOST name, USER NAME, PASSWORD and INTERVAL.

[NOTE]

If the camera has not been registered to the DDNS host previously, the registration is required. If the camera is already registered but its IP address changes, the DDNS must be updated with this new IP address. It will update at a regular interval.

TCP/IP	DDNS	RTP	UPnP	Zeroconf	Bonjour
<input type="checkbox"/> Enable					
DDNS server		dyndns.org <input type="button" value="v"/>			
Registered host		<input type="text"/>			
User name		<input type="text"/>			
Password		<input type="text"/>			
Confirm password		<input type="text"/>			
Update interval		1 hour <input type="button" value="v"/>			

Full Menu Setup

• RTP

- > **START PORT & END PORT** : RTP port range defines the range of the ports from which ports of the video/audio are automatically selected. This feature is useful if the camera is connected to a NAT router with manually configured port mapping. Limit the range of the ports permitted for RTP unicast/multicast by entering **START PORT** and **END PORT**.
- > **MULTICAST - STREAM1, 2, 3** : Only IP addresses within certain ranges can be used for multicasting. The camera has been pre-configured with addresses from these ranges and does not normally need to be reconfigured. If an address needs to be changed, please contact the network administrator.
 - Mark **ENABLE** checkbox to use the multicast for each stream.
 - **DESTINATION IP**: Type IP address in the range. Multicast addresses are allocated according to these IANA policies.
 - **PORT** : Use the port number in the range 1024-65532. Default is 4000.
 - **TTL** : When IP packets or data fails to be delivered to the destination within TTL (Time To Live), this setting tells the network router when to discard the packet. The value is usually measured in 'hops', i.e. the number of network routers that can be passed before the packet arrives at its destination or is dropped.

TCP/IP	DDNS	RTP	UPnP	Zeroconf	Bonjour
Start port		<input type="text" value="30000"/>	[30000... 39800; Only even values are available]		
End port		<input type="text" value="30199"/>			
Multicast - Stream 1					
<input type="checkbox"/> Enable					
Destination IP		<input type="text" value="231"/> · <input type="text" value="1"/> · <input type="text" value="128"/> · <input type="text" value="20"/>	[224.0.0.0... 239.255.255.255]		
Port		<input type="text" value="40000"/>	[1024... 65530; Only even values are available]		
TTL		<input type="text" value="1"/>	[1... 255]		
Multicast - Stream 2					
<input type="checkbox"/> Enable					
Destination IP		<input type="text" value="231"/> · <input type="text" value="1"/> · <input type="text" value="128"/> · <input type="text" value="21"/>	[224.0.0.0... 239.255.255.255]		
Port		<input type="text" value="40000"/>	[1024... 65530; Only even values are available]		
TTL		<input type="text" value="1"/>	[1... 255]		
Multicast - Stream 3					

Full Menu Setup

• UPNP

UPnP is enabled by default so that the network camera can be automatically detected by operating systems and clients that support this protocol.

> FRIENDLY NAME : Enter the name up to 32 alphanumeric characters like Model Name-MAC address.

[NOTE]

UPnP must also be enabled on your Windows computer. To do this, open the Control Panel from the Start Menu and select Add/Rename programs. Select Add / Remove Windows Components and open the Networking Services section. Click Details and then select UPnP as the service to add.

TCP/IP DDNS RTP **UPnP** Zeroconf Bonjour

Enable

Friendly name

• Zeroconf

ZeroConf (Zero configuration) networking enables the network to establish automatically with the automatic assignment of numeric network addresses (zeroconf IP addresses) without requiring manual operator intervention or special configuration servers when the DHCP server is not available in the network.

> Mark ENABLE to use ZeroConf networking.

> ZeroConf ADDRESS : 169.254.xxx.xxx as default.

TCP/IP DDNS RTP UPnP **Zeroconf** Bonjour

Enable

Zeroconf address

• Bonjour

Bonjour is Apple's implementation of zero-configuration networking (zeroconf), a group of technologies that includes service discovery, address assignment, and hostname resolution.

TCP/IP DDNS RTP UPnP Zeroconf **Bonjour**

Enable

Friendly name

Full Menu Setup

3-6-4. Language

4 languages are available to select from English, Deutsch (German), Français (French), and 한국어 (Korean).

3-6-5. Maintenance

The screenshot shows the 'Maintain' menu with the following options:

- Restart**: Restart the unit.
- Reset**: Resets all parameters to the original factory settings, except the IP address and PTZ configurations.
- Default**: Resets all parameters to the original factory settings.

The 'Upgrade' section includes a note:

- Please make sure that 'Reset' is essential after downgrading the firmware.
- Please do the Reset in SETUP > System > Maintenance > Reset.

Below the note, there is a text area for the firmware file and an 'Upgrade' button.

The 'Setup Export' section has an 'Export' button to save all parameters and user-defined scripts.

The 'Setup Import' section has an 'Import' button to import configurations from an exported file.

● **Maintain**

- > **RESTART** : Restarts the camera without changing any settings.
- > **RESET** : Restarts and loads the factory settings but does not change IP address and PTZ settings.
- > **DEFAULT** : Loads and saves the factory defaults for all parameters including IP address and PTZ settings.

[CAUTION]

Do not disconnect the power or network cable during RESET or DEFAULT operations.

Full Menu Setup

• **Upgrade**

Bring the firmware file to the drop box or click the drop box to browse for the firmware file, and then click the UPGRADE button.

[**CAUTION**] Do not disconnect the power or network cable during firmware UPGRADE.

• **Setup Export**

Current configurations for the camera can be saved as a file by clicking the EXPORT button.

• **Setup Import**

The exported configuration file from a reference camera or a backup configuration can be imported and configured/reloaded onto other cameras.

[**NOTE**]

- SETUP EXPORT/SETUP IMPORT can only be used on the same camera models with the same firmware. This feature is not intended for the configuration of multiple units or for firmware upgrades.
- When the encrypted System configuration file with the password is imported, type the password at SETUP>SYSTEM>SECURITY>EXPORT/IMPORT with the SAME password which was used in exporting the system configuration file from the reference camera. Otherwise, 'INVALID FILE' error appears.

3-6-6. Logs & Report

• **Logs**

The log file records the story into the unit since the system restarts.

- > DATABASE CAPACITY: Shows the useable system memory space for Log file.
- > SEARCH CONDITION: Allows you to search the log as per the type. E.g. System, Access, Event and Media, Start-End date and Start-End time.
- > LOG LIST: Shows the logs as per the search.

• **Logs Server**

Mark ENABLE checkbox to receive log data from camera to server.

- > TLS Encryption: Mark checkbox to encrypt the communication data.
- > Type: Selects the network protocol to connect the server.
- > Format: Selects the log protocol.
- > Server address: Inputs the server address.
- > Server port: Inputs the server port.

• **Report**

Provides overall information about the server status.

Full Menu Setup

4. 4 EYES PRINCIPLE

> Four Eyes Principle Setting :

- Mark **ENABLE** checkbox to enable 4 EYES PRINCIPLE function.
Administrators(user authority) are authorized to **ENABLE/DISABLE** 4 EYES PRINCIPLE function.

Two individual administrators(user authority) should approve to playback recorded data on Micro SD card for data security.

One administrator should click Approval #1 and the other administrator should click Approval #2.

- Mark **DISABLE** checkbox to disable 4 EYES PRINCIPLE function.
Single administrator(user authority) can access **PLAYBACK** menu and replay recorded data on Micro SD.
All users with **REPLAY** authority can access the **PLAYBACK** menu.

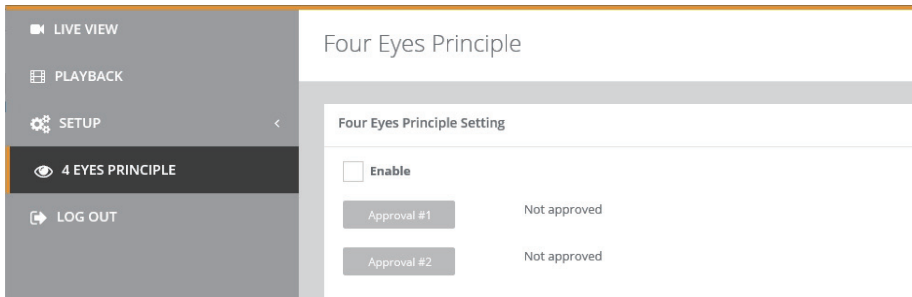

Troubleshooting

If you suspect a problem is being caused by incorrect configuration or some other minor problem, consult the troubleshooting guide below.

Upgrading the Firmware

Firmware is software that determines the functionality of the network camera. One of your first actions when troubleshooting a problem should be to check the current firmware. The latest version may contain a correction that fixes your particular problem. The current firmware version in your camera is displayed on the Basic Configuration or About. For the latest firmware of the camera, please contact with your product administrator.

Detailed instructions on how to perform the upgrade process are provided with each new release.

General Troubleshooting

The following list covers some of the problems that may be encountered and suggests how to remedy them:

Symptom	Guide
The camera cannot be accessed by some clients.	If using a proxy server, try disabling the proxy setting in your browser. Check all cabling and connectors.
The camera works locally, but not externally	Check if there are firewall settings that need to be adjusted. Check if there are router settings that need to be configured.
Poor or intermittent network connection.	If using a network switch, check that the port on that device uses the same setting for the network connection type (speed/duplex).
The camera cannot be accessed via a host name.	Check that the host name and DNS server settings are correct.
Not possible to log in.	When HTTPS is enabled, ensure that the correct protocol (HTTP or HTTPS) is used. When attempting to log in, you may need to manually type in http or https in the browser's address bar.
No image using Refresh and/or slow updating of images.	If images are very complex, try limiting the number of clients accessing the camera.
Images only shown in black & white.	Check the Video & Image setting.
Blurred images.	Refocus the camera.

Troubleshooting

Poor image quality.	Increased lighting can often improve image quality. Check that there is sufficient lighting at the monitored location. Check all image and lighting settings.
Rolling dark bands or flickering in image.	Try adjusting the Exposure Control setting under AE and AWB part.
H.265, H.264 not displayed in the client.	Check that the correct network interface is selected in the Video & Image/Stream.
Multicast H.265, H.264 not displayed in the client.	Check with your network administrator that the multicast addresses used by the camera are valid for your network. Check that the Enable multicast checkbox are enabled in the System/Network/RTP tab. Checks with your network administrator to see if there is a firewall preventing viewing.
Multicast H.265, H.264 only accessible by local clients.	Check if your router supports multicasting, or if the router settings between the client and the server need to be configured. The TTL value may need to be increased.
Color saturation is different in H.265, H.264 and Motion JPEG.	Modify the settings for your graphics adapter. Please see the adapter's documentation for more information.
Poor audio quality.	Too many users/clients connected to the camera may affect the sound quality adversely. Try limiting the number of clients allowed to connect.
Distorted audio.	Check that the correct Audio Input source is selected. Select Microphone for a connected external microphone. Select Line for a connected line in source.



eneo® is a registered trademark of
VIDEOR E. Hartig GmbH
Exclusive distribution through specialised
trade channels only.

VIDEOR E. Hartig GmbH
Carl-Zeiss-Straße 8
63322 Rödermark/Germany
Tel. +49 (0) 6074 / 888-0
Fax +49 (0) 6074 / 888-100
www.videor.com
www.eneo-security.com

Technical changes reserved

© Copyright by VIDEOR E. Hartig
GmbH Version 11/2020