



EN

User Manual

**Network Video Recorder, H.265,
HDMI, VGA, PoE, w/o HDD**

IER-28R040005A



IER-28R080005A

IER-28R160005A

WARNING

TO REDUCE THE RISK OF FIRE OR ELECTRIC SHOCK, DO NOT EXPOSE THIS PRODUCT TO RAIN OR MOISTURE. DO NOT INSERT ANY METALLIC OBJECT THROUGH THE VENTILATION GRILLS OR OTHER OPENINGS ON THE EQUIPMENT.

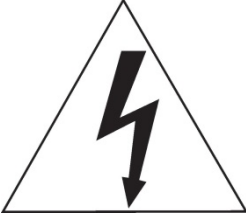
CAUTION

	CAUTION RISK OF ELECTRIC SHOCK DO NOT OPEN	
<p>WARNING: TO REDUCE THE RISK OF ELECTRIC SHOCK, DO NOT REMOVE COVER (OR BACK). NO USER-SERVICABLE PARTS INSIDE. REFER SERVICING TO QUALIFIED SERVICE PERSONNEL</p>		

EXPLANATION OF GRAPHICAL SYMBOLS



The lightning flash with arrowhead symbol, within an equilateral triangle, is intended to alert the user to the presence of dangerous voltage within the products enclosure that may be of sufficient magnitude to constitute a risk of electric shock to persons.



The exclamation point within an equilateral triangle is intended to alert the user to the presence of important operating and maintenance (servicing) instructions in the literature accompanying the product.

FCC COMPLIANCE STATEMENT

This device complies with Part 15 of the FCC Rules. Operation is subject to the following two conditions: (1) this device may not cause harmful interference, and (2) this device must accept any interference received, including interference that may cause undesired operation.

FCC INFORMATION: This equipment has been tested and found to comply with the limits for a Class A digital device, pursuant to Part 15 of the FCC Rules. These limits are designed to provide reasonable protection against harmful interference when the equipment is operated in a commercial environment. This equipment generates, uses, and can radiate radio frequency energy and, if not installed and used in accordance with the instruction manual, may cause harmful interference to radio communications. Operation of this equipment in a residential area is likely to cause harmful interference in which case the user will be required to correct the interference at his own expense.

CAUTION: Changes or modifications not expressly approved by the party responsible for compliance could void the user's authority to operate the equipment.

This Class A digital apparatus complies with Canadian ICES-003.
Cet appareil numérique de la classe A est conforme à la norme NMB-003 du Canada.

CE COMPLIANCE STATEMENT

WARNING

This is a Class A product. In a domestic environment this product may cause radio interference in which case the user may be required to take adequate measures.

CAUTION

RISK OF EXPLOSION IF BATTERY IS REPLACED BY AN INCORRECT TYPE.
DISPOSE OF USED BATTERIES ACCORDING TO THE INSTRUCTIONS.

IMPORTANT SAFETY INSTRUCTIONS

1. Read these instructions.
2. Keep these instructions.
3. Heed all warnings.
4. Follow all instructions.
5. Do not use this apparatus near water.
6. Clean only with dry cloth.
7. Do not block any ventilation openings. Install in accordance with the manufacturer's instructions.
8. Do not install near any heat sources such as radiators, heat registers, stoves, or other apparatus (including amplifiers) that produce heat.
9. Do not defeat the safety purpose of the polarized or grounding-type plug. A polarized plug has two blades with one wider than the other. A grounding type plug has two blades and a third grounding prong. The wide blade or the third prong is provided for your safety. If the provided plug does not fit into your outlet, consult an electrician for replacement of the obsolete outlet.
10. Protect the power cord from being walked on or pinched particularly at plugs, convenience receptacles, and the point where they exit from the apparatus.
11. Only use attachments/accessories specified by the manufacturer.
12. Use only with the cart, stand, tripod, bracket, or table specified by the manufacturer, or sold with the apparatus. When a cart is used, use caution when moving the cart/apparatus combination to avoid injury from tip-over.
13. Unplug this apparatus during lightning storms or when unused for long periods of time.
14. Refer all servicing to qualified service personnel. Servicing is required when the apparatus has been damaged in any way, such as power-supply cord or plug is damaged, liquid has been spilled or objects have fallen into the apparatus, the apparatus has been exposed to rain or moisture, does not operate normally, or has been dropped.
15. **CAUTION – THESE SERVICING INSTRUCTIONS ARE FOR USE BY QUALIFIED SERVICE PERSONNEL ONLY. TO REDUCE THE RISK OF ELECTRIC SHOCK DO NOT PERFORM ANY SERVICING OTHER THAN THAT CONTAINED IN THE OPERATING INSTRUCTIONS UNLESS YOU ARE QUALIFIED TO DO SO.**
16. **Use satisfy clause 2.5 of IEC60950-1/UL60950-1 or Certified/Listed Class 2 power source only.**
17. ITE is to be connected only to PoE networks without routing to the outside plant.



Table of Contents

Table of Contents	1
1. Overview	3
1.1 Package Contents.....	4
1.2 NVR Description.....	4
2. Installation	6
2.1 Installing HDD	7
2.2 Connecting with Exterior Device	7
2.3 Starting System	9
2.4 Quick Setup	9
2.4.1 Account.....	10
2.4.2 System.....	12
2.4.3 Network	12
2.4.4 Time/Date	13
2.4.5 Easy Installation Wizard.....	14
3. Live Screen Configuration	15
3.1 Icons in Live screen.....	16
3.2 Live Launcher menu	18
3.2.1 Backup.....	19
3.3 Quick menu.....	21
3.3.1 PTZ Control	22
3.3.2 Camera Registration.....	24
3.3.3 Status > System log.....	26
3.3.4 Status > Event.....	27
3.3.5 Status > Record	28
3.3.6 Status > Disk.....	29
4. Setup menu	30
4.1 General buttons in Setup menu	32
4.2 SYSTEM.....	33
4.2.1 System.....	33
4.2.2 Time/Date	35
4.2.3 Account > User	37
4.2.4 Config (Configuration)	40

4.3	CAMERA	42
4.3.1	Basic	42
4.3.2	Advanced	44
4.3.3	Registration	48
4.3.4	Account.....	49
4.4	DEVICE.....	52
4.4.1	Display.....	52
4.4.2	Disk > Setup.....	56
4.4.3	PTZ > PTZ.....	59
4.4.4	Serial Device > Serial Device.....	60
4.4.5	TEXT > TEXT.....	61
4.5	RECORD	63
4.5.1	Schedule > Schedule.....	63
4.5.2	Stream.....	66
4.6	EVENT.....	69
4.6.1	System/Disk.....	69
4.6.2	Alarm In.....	71
4.6.3	Motion	74
4.6.4	Video Loss > Setup.....	77
4.6.5	Notification	78
4.7	NETWORK.....	80
4.7.1	Basic	80
4.7.2	DVRNS.....	84
4.7.3	E-Mail	85
4.7.4	FTP	86
4.7.5	Remote Access.....	87
4.7.6	P2P	89
4.7.7	Notification Server	90
5.	Search/Playback	93
5.1	Search.....	93
5.2	Playback.....	98
6.	Webviewer	100
7.	Appendix	104
7.1	Installing System Keyboard.....	104
7.2	Product Specification	109

1. Overview

This chapter describes NVR overview, components and their terms and features.

This manual introduces a network video recorder (NVR) which monitors or record, controls images via a network camera.

Multiple users may monitor video at the same time, and many cameras can be controlled simultaneously by a manager. Also, through a PC or a smartphone, video might be monitored by transmitting video and audio using a network.

The device features include the following:

- Convenient UI from user's viewpoint
- IP camera input 4/8/16 channels
- Providing H.264 and H.265 compression
- Up to 4K real time recording
- HDD information and status presentation
- HDD overwriting
- High capacity back-up with USB 3.0
- Simultaneous recoding and playing of 4/8/16 channels
- Various search mode (time, event, thumbnail, smart search, text and VCA)
- Various recording mode (manual, event, timed recording, panic recording)
- Remote monitoring through a network viewer, a web viewer, and a mobile viewer

1.1 Package Contents

The device package contents consist of the following:

 **Note** Please check all components involved.

Table 1-1 Package contents

No.	Name	No.	Name
1	NVR	5	Program CD
2	DC Adapter & Power cord	6	SATA cable
3	Mouse	7	SATA power cable
4	Quick guide	8	HDD fixing screw

1.2 NVR Description

Each part is listed in the below:

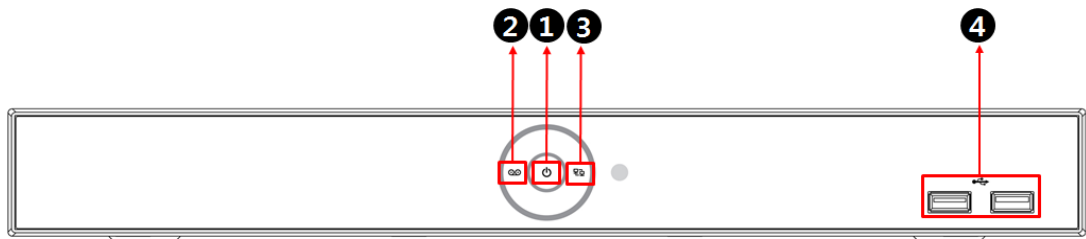
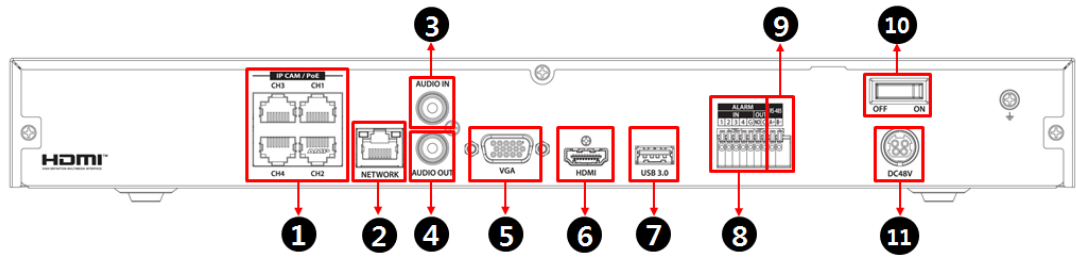

Figure 1-1 Name and Connection of each front section

Table 1-2 Name and Function of each front section

No.	Name	Function
1	Power status LED	Pointing out device on/off.
2	Recording status LED	Pointing out recording in process.
3	Network LED	With a network viewer, pointing out network in connection.
4	USB port	USB port is connected for USB mouse or firmware upgrade, and data back-up.

4CH NVR



8CH NVR

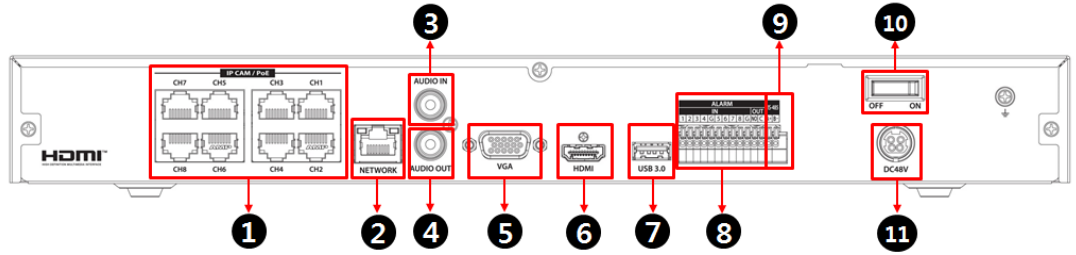

16CH NVR

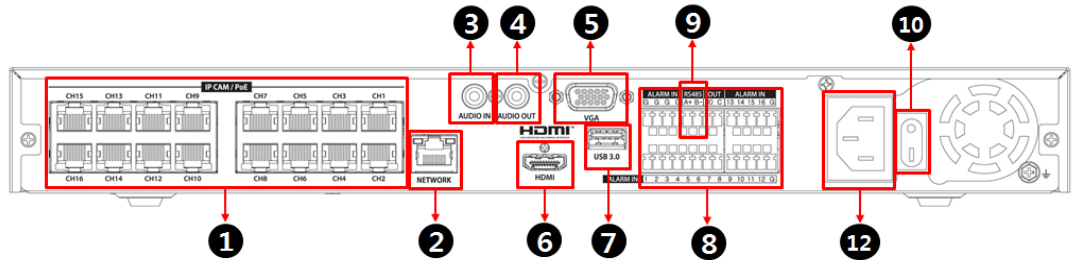

Figure 1-2 Name and Connection of rear section of 4ch, 8ch and 16ch NVR

Table 1-3 Name and Function of rear section of 4ch, 8ch and 16ch NVR

No.	Name	Function
1	IP CAM / PoE	IP camera input port, IEEE802.3at PoE support.
2	Network	Network connector.
3	Audio In	Audio input port.
4	Audio Out	Audio output port.
5	VGA	VGA output port.
6	HDMI	HDMI output port.
7	USB 3.0	USB 3.0 port is connected for data back-up.
8	Alarm In/Out	Alarm connector.
9	RS485	RS-485 communication connector.
10	Power Switch	Power On-Off.
11	DC48V	DC Adapter input port.
12	AC POWER INPUT	AC Power cord input port.

2. Installation

This chapter describes the way to install NVR.

When installing a device, connect rear of the device with each port on the basis of below connection map.

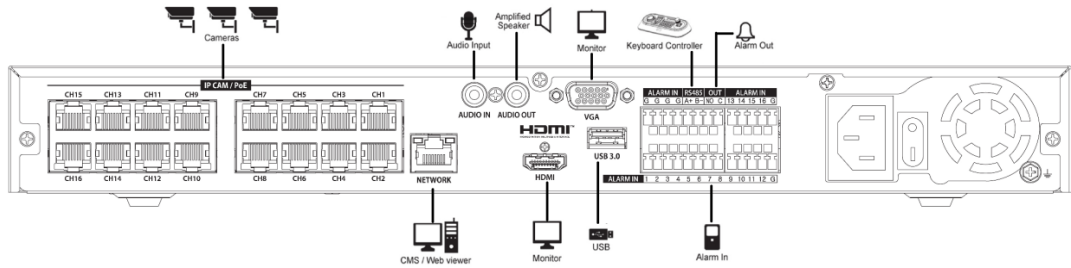

Figure 2-1 Connection map

The device starts first like below sequences:

- 1 Installing HDD
- 2 Connecting with an exterior device
- 3 Starting a system
- 4 Setting a quick setup

2.1 Installing HDD

How to install HDD in the device:



- Withdraw the mains plug before installing HDD to reduce the risk of injury or electrical shock, or device malfunction.
- Make sure to check the compatibility of HDD with the device.

- 1 Always switch off and unplug the unit.
- 2 Unscrew with a screw driver (+) and open the unit cover.
- 3 Install HDD in the bottom case.
- 4 Connect a data cable and power cable with HDD.
- 5 Close the cover and tighten screws.

2.2 Connecting with Exterior Device

How to connect each port to rear section of the unit:

- 1 Place the unit in a stable flat surface.
- 2 Make a room between front/rear sides of the device not to break connectors.



Do NOT install the device too close to the wall. Protrusive connects rear the unit may be forcedly curved or pressed, which cause fires, electric shocks, or injury.

- 3 Check to switch off and unplug the unit.



Make sure to withdraw the mains plug before installing the device.

- 4 Connect input ports of IP camera .

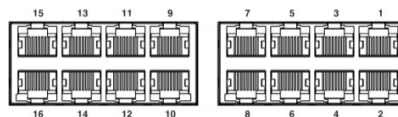

Note Connecting a camera port with the unit automatically detects the camera.

- 5 Connect audio input and output port with a mic and speaker.



Note Assure regulations in the area whether recording to be legal or not.

- 6 Connect a monitor with VGA or HDDMI port.



7 Connect a network port.

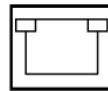

NETWORK

8 Connect an alarm and RS485 device.

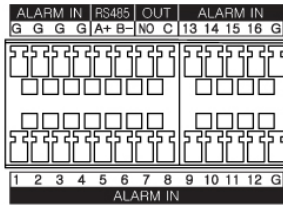

9 Connect USB port for data back-up.

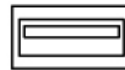

USB

10 Supply the main power after completion.

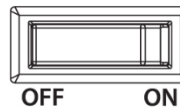

Power Switch

2.3 Starting System

Power supply begins with system operation as follows:

11 Switching on initialize with below icons in order.



Note Installing new HDD might take more initialize time.

12 With buzzer sounds, the start screen is presented.

13 In **Log in** screen, enter the **ID, Password** and press **OK**.

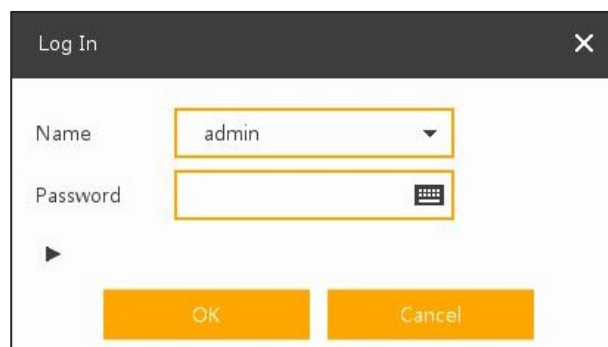

Note Default ID & Password is admin/admin

 **Attention** Please change password after login due to security.

Click  to see the MAC address.

Note If lost password, inform the MAC address to supplier to create temporary password.

2.4 Quick Setup

First start of the system operates Easy Installation as follows:

- 1 Account
- 2 System
- 3 Network
- 4 Time/Date
- 5 Easy Installation Wizard

2.4.1 Account

How to set Account of Easy Installation:

- 1 Click the keyboard icon to set **ID** and **Password** users want.

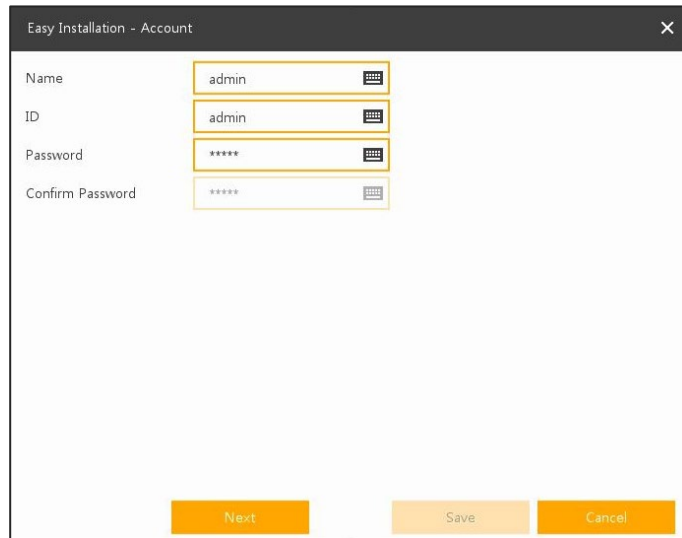

- 2 Creation if an error occurs, an error window is provided, and then a confirmation window is provided.

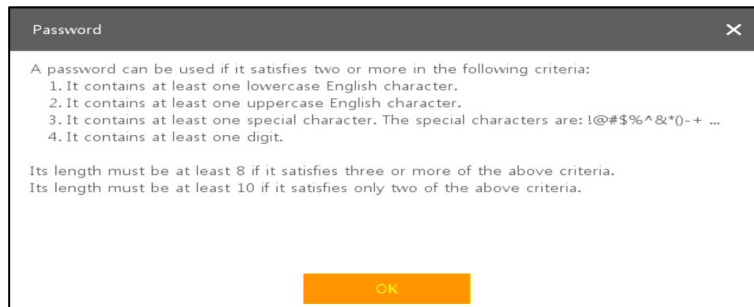

Note

A password can be used if it satisfies two or more in the following criteria:

1. It contains at least one lowercase English character.
2. It contains at least one uppercase English character.
3. It contains at least one special character. The special characters are: !@#\$\$%^&*()-+ ...
4. It contains at least one digit.

Its length must be at least 10 if it satisfies only two of the above criteria.

Its length must be at least 8 if it satisfies three or more of the above criteria.

- 3 With keyboard UI, set the **ID** and **Password**, and press **OK**.

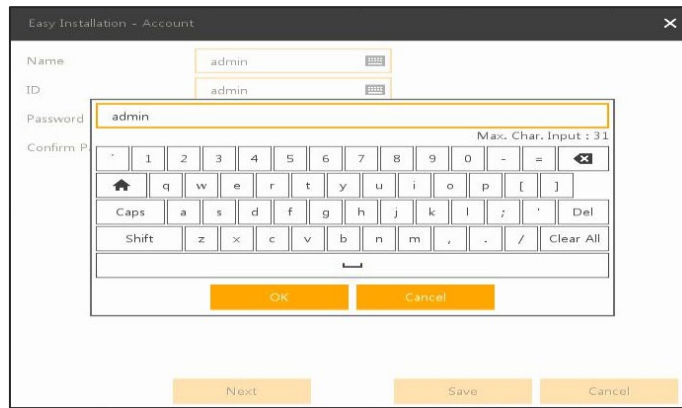

- Default ID/Password is admin/admin.
- Change the password for security.
- Max character length is 16.

Note

- 4 Press the **Save** button to save newly set **ID** and **Password**.
- 5 Press **Next** button to end Account setting and move the next setting phase.

2.4.2 System

How to set the system of Easy Installation:

- 1 Set each item in **System** setting screen.

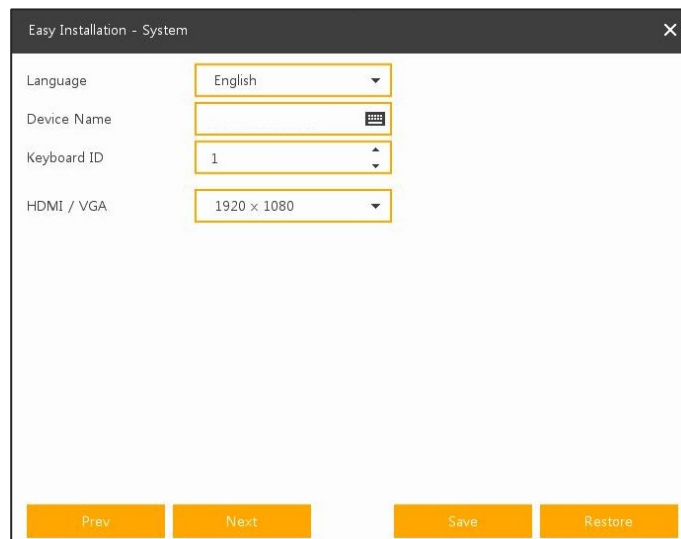

The screenshot shows a window titled "Easy Installation - System" with a close button (X) in the top right corner. The window contains four configuration items, each with a label and a control element:

- Language:** A dropdown menu currently showing "English".
- Device Name:** A text input field with a keyboard icon on the right.
- Keyboard ID:** A dropdown menu currently showing "1".
- HDMI / VGA:** A dropdown menu currently showing "1920 x 1080".

At the bottom of the window, there are four orange buttons: "Prev", "Next", "Save", and "Restore".

- Language: Select system language.
- Device Name: Enter the device name.
- Keyboard ID: To identify device usages in controlling NVR with RS485 through a keyboard
- Selecting the device ID. In case of simultaneous use of equipment, set ID with difference.

Note ■ As for using many NVRs, set ID with difference.

- HDMI/VGA: Set resolution of a monitor connected to the device.

Note ■ Video is not displayed through VGA port if set 3840x2160 resolution.
■ If resolution is set to 3840x2160 and a monitor that does not support this resolution is connected to the HDMI port, it will automatically change to 1024x768 resolution.

2 Press **Save** button to save set value.

3 Press **Next** to end System setting and move the next setting phase.

2.4.3 Network

How to set the network of Easy Installation:

- 1 Set each item in **Network** setting screen.

Easy Installation - Network

WAN Port Static IP DHCP (Dynamic)

IP Address 192.168.1.10

Subnet Mask 255.255.255.0

Gateway 192.168.1.1

DNS 8.8.8.8

Port (TCP) 9350

Port (HTTP / HTTPS) 80 443

PoE Ports Server 192.168.30.1

Prev Next Save Cancel

- WAN Port: Select whether to use static IP or dynamic IP.
 - IP Address, Subnet Mask, Gateway, DNS, and Port: As for dynamic IP, enter information in each space.
- 2 Press **Save** button to save set value.
 - 3 Press **Next** to end Network setting and move the next setting phase.

2.4.4 Time/Date

How to set the time/date of Easy Installation:

- 1 Set each item in **Time/Date** setting screen.

Easy Installation - Time / Date

Network Time Sync Use

System Time 2019/08/14 16:31:12 DST

Time Zone 00:00 Casablanca, Coordinated Universal Time, Dublin, Edinbur

DST Start 1 1st SUN (0H:0M)

DST End 12 1st SUN (0H:0M)

Prev Next Save Cancel

- Network Time Sync: Select network for synchronizing with time server.
- System Time: Not for synchronizing with network time server, set the device time; otherwise (applying for Daylight saving time), select DST.
- Time Zone: Select time zone for the system being installed.
- DST Start/End: For applying Daylight saving time, set the application period.

- 2 Press **Save** button to save set value.
- 3 Press **Next** to end Time/Date setting and move the next setting phase.

2.4.5 Easy Installation Wizard

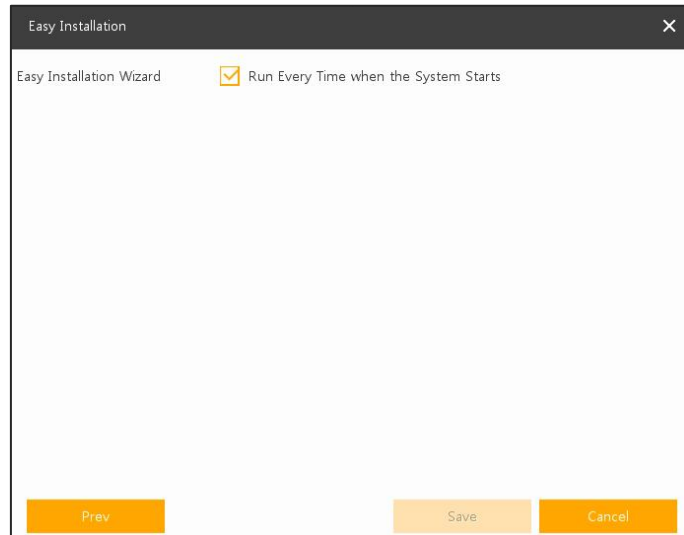

- 1 Select to run Easy Installation every time when the system start.
- 2 Press **Save** button to save set value and end Easy Installation.

3. Live Screen Configuration

UI screen is configured like below figure.

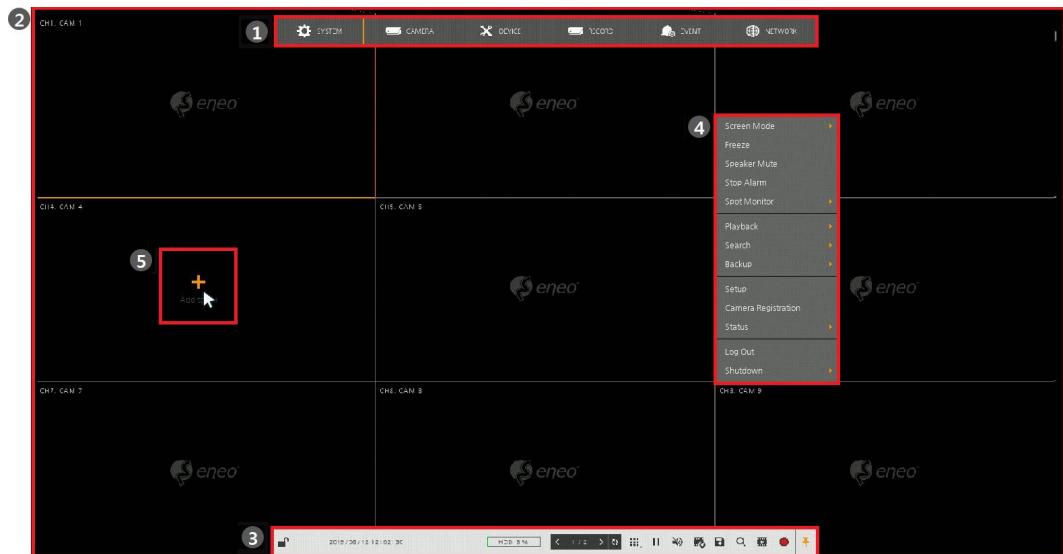

Figure 3-1 UI Screen Configuration

Table 3-1 Items and Description of UI Screen Configuration

No.	Item	Description
1	Setup menu	Setting menu is located in the corner of upper screen. See "4 Setup menu" to display detailed information about the setting menu.
2	Live screen	Show live video of connected cameras.
3	Launcher menu	Launcher menu is located in the corner of below screen. See "3.2 Live Launcher menu" to display detailed information about the launcher menu.
4	Quick menu	Clicking the right button of a mouse displays Quick menu. See "3.3 Quick menu" to display detailed information about the quick menu.
5	Add to CH	Move mouse cursor on the center of window to register IP camera manually. See "3.3.2 Camera Registration" to display detailed information about the camera registration.

3.1 Icons in Live screen

Each icon in the live screen displays a present setting status or a function. UI screen consists of like below.



Figure 3-2 Live screen icon

Table 3-2 Live screen icon and its description

No.	Icon	Description
1	CH1 CAM1	Channel numbers and camera titles.
2		A camera with PTZ function.
3		PTZ control function in process.
4		Recording in alarm event mode.
5		Recording in motion event mode.
6		Recording in panic recording mode.
7		Recording in consecutive recording mode.
8		Video loss icon.
9		Mic on/off.
10		Speaker on/off.
11		Displaying present time and date.

Note Chosen live screen is marked as a blue frame; mouse-located live screen is marked as yellow one.

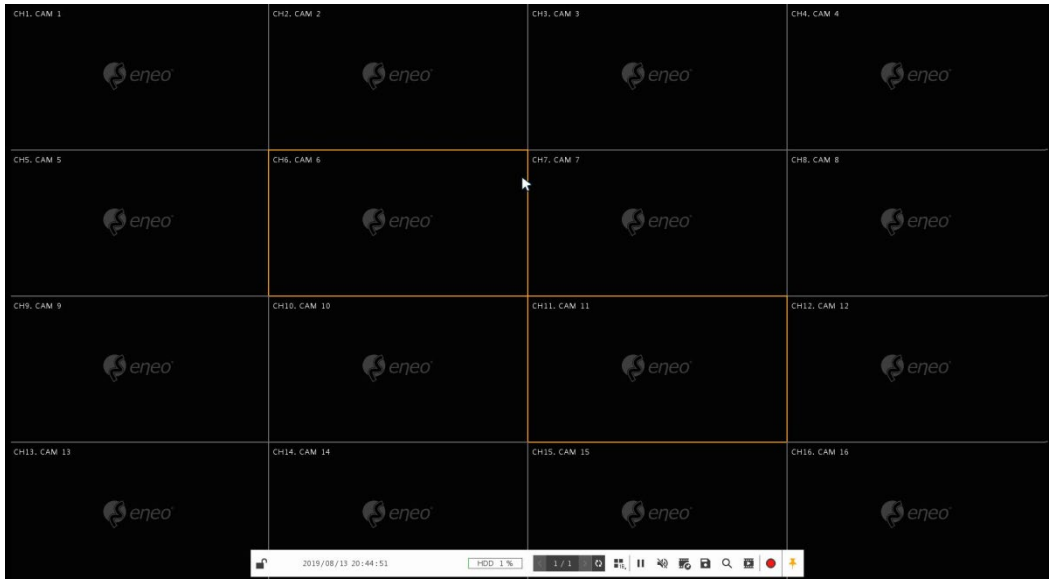

Figure 3-3 Chosen live screen channel

3.2 Live Launcher menu

This chapter describes Launcher menu in the bottom of the screen.



Figure 3-4 Launcher menu

Table 3-3 Launcher menu Item and Description

No.	Item	Description
1		Log in/out status and logged in ID.
2	Date & Time	Displaying present date and time.
3	HDD	Displaying HDD capacity in use.
4		Moving to previous/next partition screen.
5		Displaying live screen in order set (toggle).
6		Selecting partition mode to mark in live screen (single screen, 4-, 9-, and 16-partition).
7		Stopping or replaying selected live screen images (toggle).
8		Audio on or mute chosen live screen(toggle).
9		Instant recording for 10 seconds.
10		Make a backup video of users want. See "3.2.1 Backup" to display detailed information about back-up.
11		Searching recording data (time, event, thumbnail, smart search, text and VCA). See "5.1 Search" to display detailed information about search.
12		Playback recorded data.
13		Starting immediate recording of selected channel.
14		Locking or releasing launcher menu (toggle).

3.2.1 Backup

The device provides a back-up function of live screen.

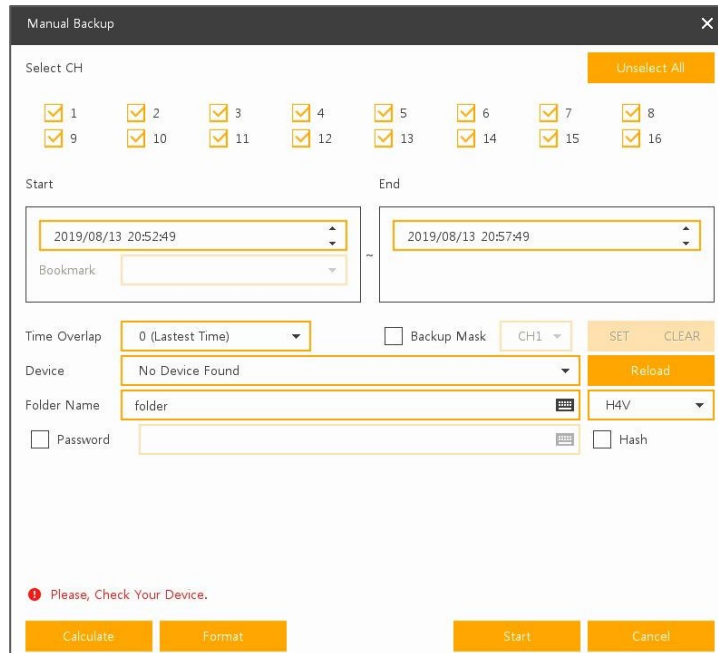

Figure 3-5 Backup

Table 3-4 Backup Item and Description

No.	Item	Description
1	Select CH	Selecting a channel users want to back-up.
2	Select All/ Unselect All	Select or clear all channels.
3	Start	Setting back-up start time (Bookmark: bookmark list).
4	End	Setting back-up ending time (Bookmark: bookmark list).
5	Time Overlap	Selecting time if there are two recorded data in the same time.
6	Backup Mask	User can mask selected area. It works H4V format only.
7	Device	Selecting the device to save back-up files.
8	Reload	Opening the device information.
9	Folder Name	Entering a folder name to save back-up files.
10	File format	Selecting a file format to back-up.
11	Calculate	Calculating data capacity to back-up.
12	Format	Formatting the device to back-up.
13	Start	Starting back-up.
14	Cancel	Closing the backup screen.
15	Hash	Insert Hash information into the backup file. The hash information can be used to verify the forgery of the backup file.

Select **Backup Mask** and click **SET** button to open the Privacy Mask pop-up window.

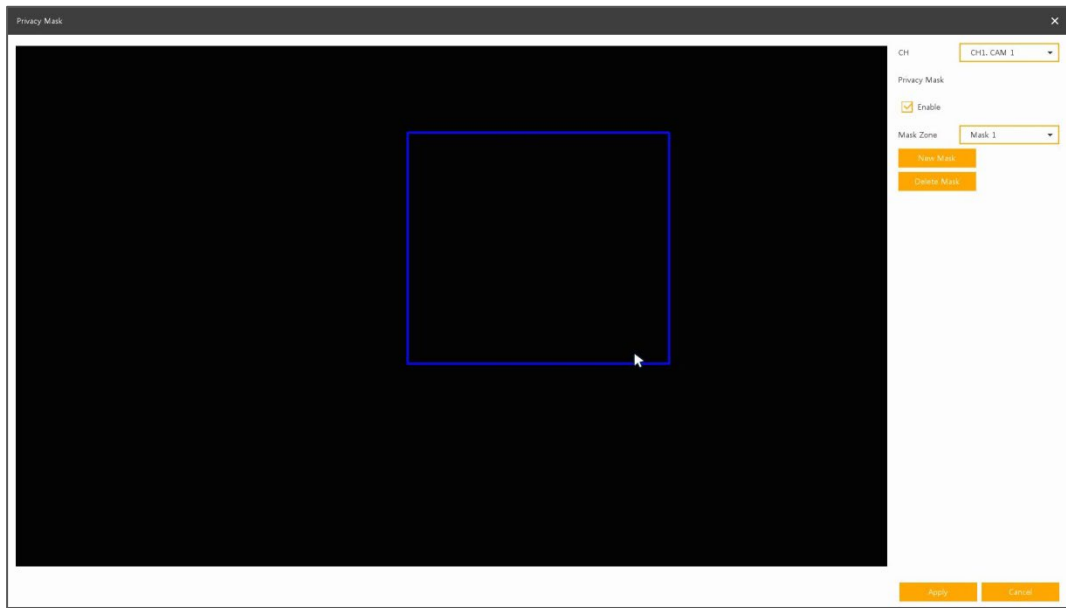

Figure 3-6 Backup Mask

Table 3-5 Backup Mask Item and Description

No.	Item	Description
1	Select CH	Select the channel to set the privacy zone.
2	Privacy Mask Enable	Select whether to use the Privacy Mask.
3	Mask Zone	Apply all or only the selected mask.
4	New Mask	Create a new privacy zone. Up to 4 masks can be created.
5	Delete Mask	Delete all or selected privacy zones.

3.3 Quick menu

This chapter depicts Quick menu when users click the right button of the mouse in live screen.

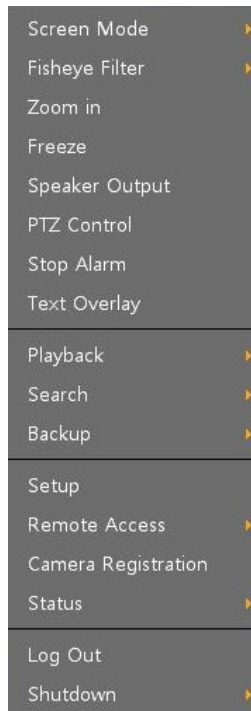

Figure 3-7 Quick menu

Table 3-6 Quick menu Item and Description

No.	Item	Description
1	Screen Mode	Selecting the partition mode of live screen (Full, 2X2, 3X3, and 4x4).
2	Fisheye Filter	Selecting Fisheye filter. This menu is shown when fisheye camera connected.
3	Zoom in	Magnifying selected live screen (Zoom out, 2 times, 4 times, and 8 times). This menu is shown full screen mode only.
4	Freeze	Freezes the video selected live screen images (toggle on / off).
5	Speaker Output/Mute	Turning on/off a sound speaker.
6	PTZ Control	Controlling PTZ function. This menu is shown when PTZ camera connected.
7	Stop Alarm	Stopping monitoring alarm output and event.
8	Text Overlay	POS text overlaid on the screen. This menu is show when enable Text menu.
9	Playback	Playing selected live screen images (before 30 sec, 1 min, 5 min, 10 min, 30 min, 1-hour, Go to last play time, and Go to last record time).
10	Search	Searching recording data (time, event, thumbnail, smart search, text and VCA). See "5.1 Search" to display detailed information about search.
11	Backup	Backup video to USB drive. See "3.2.1 Backup" to display detailed information about back-up.

No.	Item	Description
12	Setup	Opens the NVRs main set up menu. For more information about setting menu, see section "4 Setup menu".
13	Remote Access	Monitor and control for remote recorder.
14	Camera Registration	Opens a pop-up menu for IP camera registration.
15	Status	Opens a pop-up menu showing: device system log, event, and recording status (system log, event, and record).
16	Log in/Log out	Log in/Log out.
17	Shutdown	Shuts down or restarts the device (shutdown, restart).

Select Fisheye filter to dewarp fisheye camera.

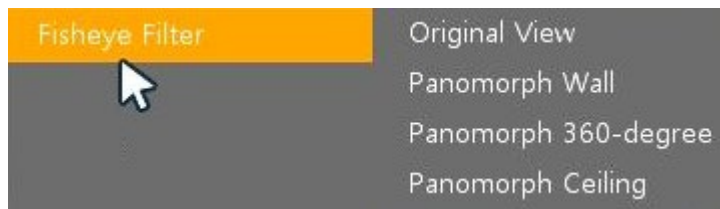

There are 3 dewarping mode as 180° Panoramic, 360° Panoramic and Dual-panoramic view.

3.3.1 PTZ Control

Users click the right button of the mouse in live screen and select PTZ control menu to control PTZ.

Note When the PTZ camera is registered, the  icon is displayed at the top of the screen. The PTZ control selection menu appears only in full screen mode.

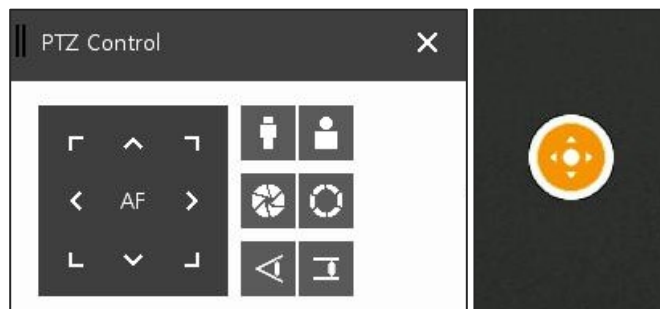
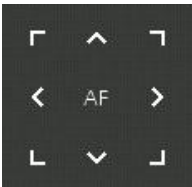









Figure 3-8 Quick menu > PTZ Control

Table 3-7 Quick menu > PTZ Control Item and Description

No.	Item	Description
1		Control pan & tilt with direction buttons.

No.	Item	Description
2		Control pan & tilt with drag the PTZ ball. Long dragging speeds up the pan/tilt speed.
3	AF	Adjusting screen focus automatically.
4	 Zoom Out	Zoom function of PTZ camera.
5	 Zoom In	
6	 IRIS Close	Adjust Iris manually.
7	 IRIS Open	
8	 Focus Far	Adjust focus manually.
9	 Focus Near	

In PTZ Control screen, clicking the right button of the mouse displays Quick menu.

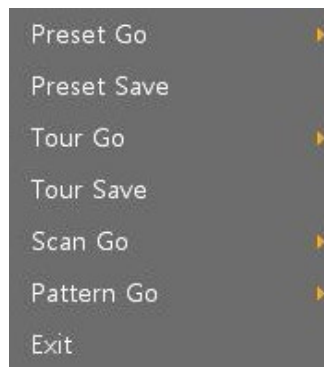

Figure 3-9 PTZ Control Quick menu

Table 3-8 PTZ Control Item and Description in Quick menu

No.	Item	Description
1	Preset Go	Run selected Preset number.
2	Preset Save	Save specific positions of the camera, at most 255 settings.
3	Tour Go	Run Tour function.
4	Tour Save	Save multiple preset positions to run each position in order.
5	Scan Go	Run Scan function.
6	Pattern Go	Run Pattern function.
7	Exit	Exit to live screen menu in PTZ Control menu.

3.3.2 Camera Registration

Users can register the IP cameras.

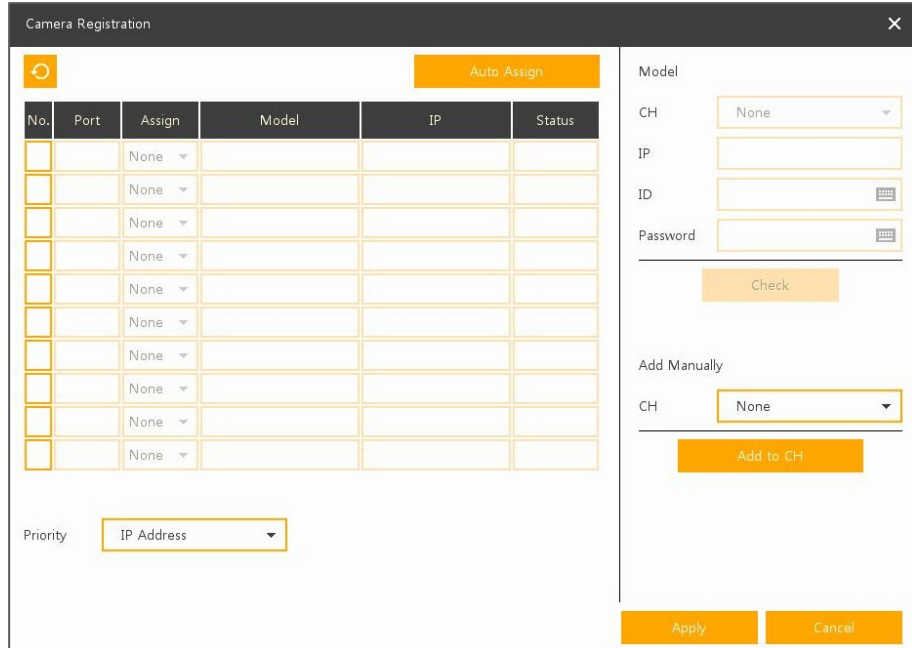





Figure 3-10 Camera Registration

Table 3-9 Camera Registration

No.	Item	Description
1		Search the connected IP cameras.
2	Auto Assign	Automatically assign the channel windows.
3	Port	Show the detected camera port (WAN, PoE).
4	Assign	Selecting the channel windows manually.
5	Model	Show detected camera model number.
6	IP	Show detected camera IP address.
7	Status	Show connection status.
8	Priority	Select IP Address or Zero conf IP. When camera have IP address and zero conf IP, NVR display selected priority address.
9	Add Manually	Select channel and click  to open manual add window.

Add Manually

Click  to open Camera Registration. Or move mouse point at the middle of channel window on the live screen and click .

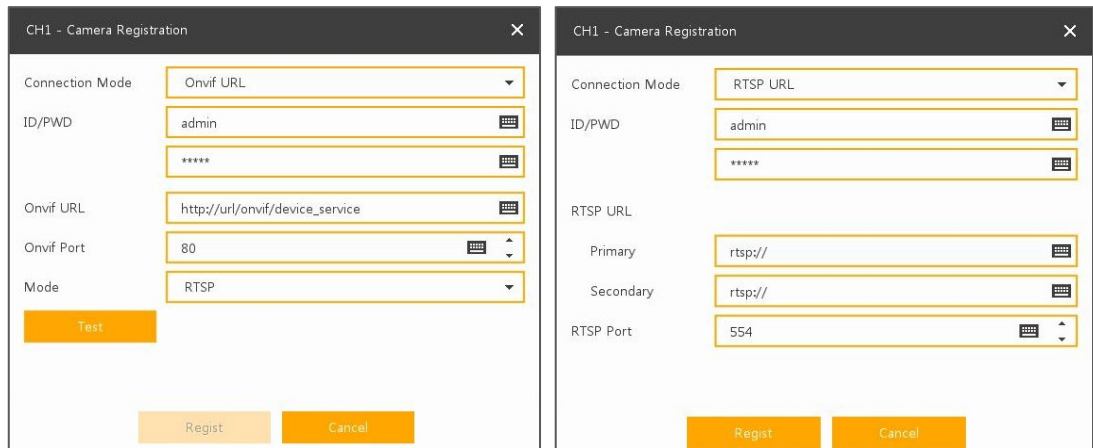

Figure 3-11 Camera Registration (manual add)

Table 3-10 Camera Registration (manual add)

No.	Item	Description
1	Connection Mode	Select connection mode as Onvif or RTSP.
2	ID/PWD	Enter ID and password of IP camera.
3	Onvif URL	Enter camera IP address.
4	RTSP URL	Enter Primary and Secondary RTSP IP address and URL.
5	Onvif Port	Enter web port. Default port is 80.
6	RTSP Port	Enter RTSP port. Default port is 554.
7	Mode	Select video stream format (RTSP/HTTP).

3.3.3 Status > System log

Users can see the system log information in **System log** tap in **Status** screen.

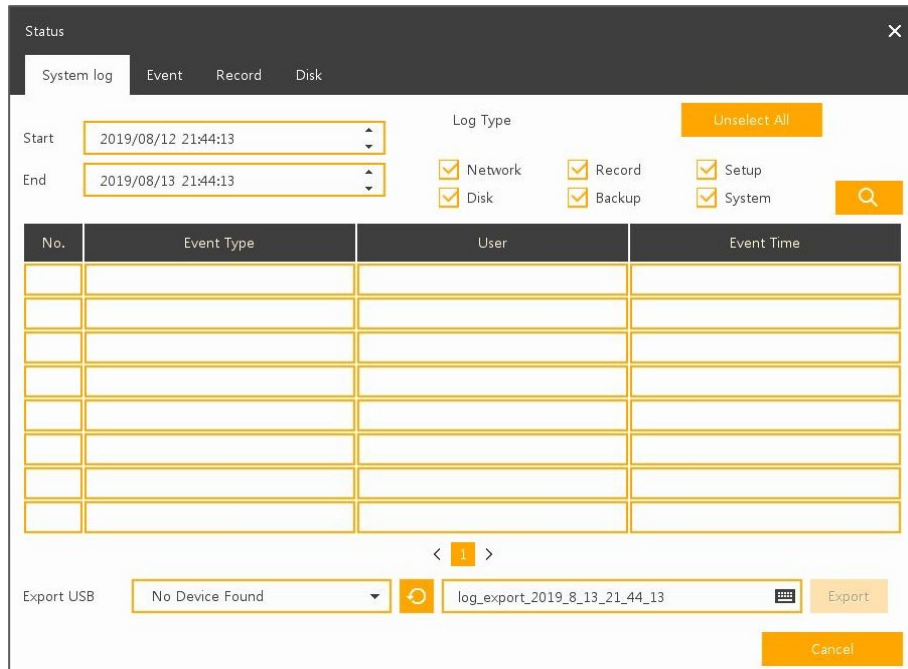



Figure 3-12 Status > System log in Quick menu

Table 3-11 Status of Quick menu > System log Item and Description

No.	Item	Description
1	Start	Setting starting time of system log to search.
2	End	Setting ending time of system log to search.
3	Log Type	Selecting log types (Network, Record, Setup, Disk, Backup, and System)
4	Select All /Unselect All	Selecting or clearing all log types (toggle).
5		Pressing search button search on the basis of set condition.
6	System log list	Displaying system log lists.
7	Export USB	Export the log data to USB thumb drive. File format is csv.
8	Cancel	Completing the status screen.

Detailed log informations

GDPR

- Users with the required authorisation can access detailed log-in records to find out with absolute certainty who exported video data, when they did so and whether they complied with the company's privacy policy (according to Art. 32 GDPR).

3.3.4 Status > Event

Users can see the real-time event information of the unit in **Event** tap in **Status** screen.

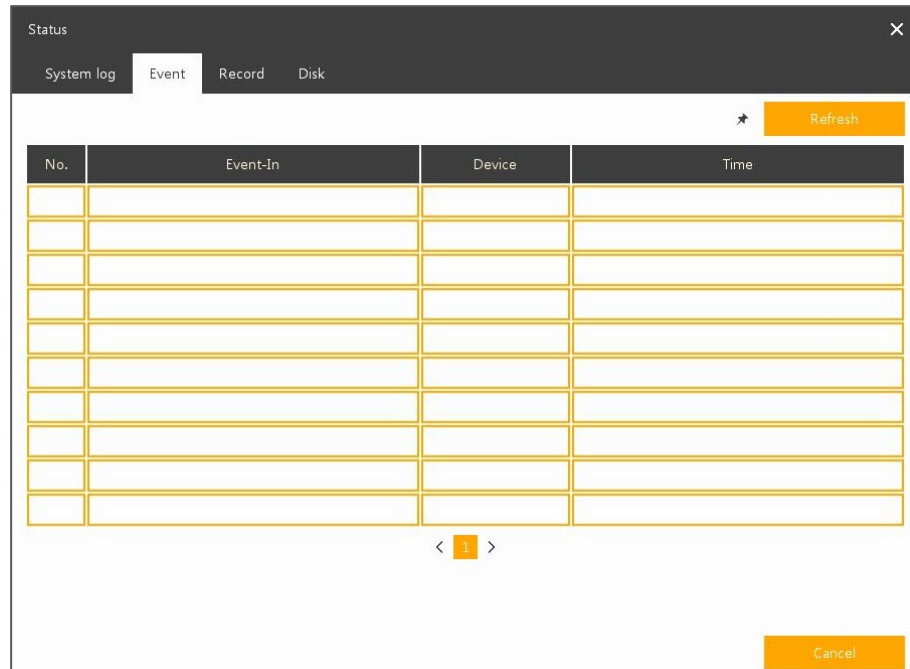

Figure 3-13 Status > Event in Quick menu

Table 3-12 Status > Event Item and Description in Quick menu

No.	Item	Description
1	★	Temporary fixing or releasing an event list (toggle).
2	Refresh	Deleting the event list.
3	Event list	Displaying the event list.
4	Cancel	Completing the status screen.

3.3.5 Status > Record

Users can see the recording status in **Record** tap in **Status** screen.

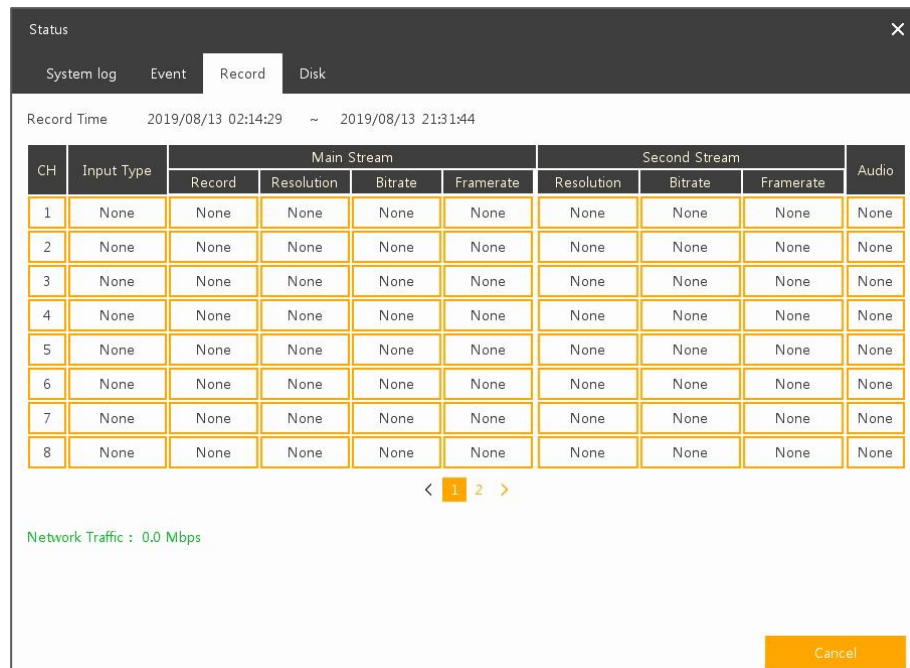

Figure 3-14 Status > Record in Quick menu

Table 3-13 Status > Record Item and Description in Quick menu

No.	Item	Description
1	Record time	Marking recorded period.
2	Record list	Displaying the record setting status.
3	Cancel	Completing the status screen.

3.3.6 Status > Disk

Users can see the disk status in **Disk** tap in **Status** screen.

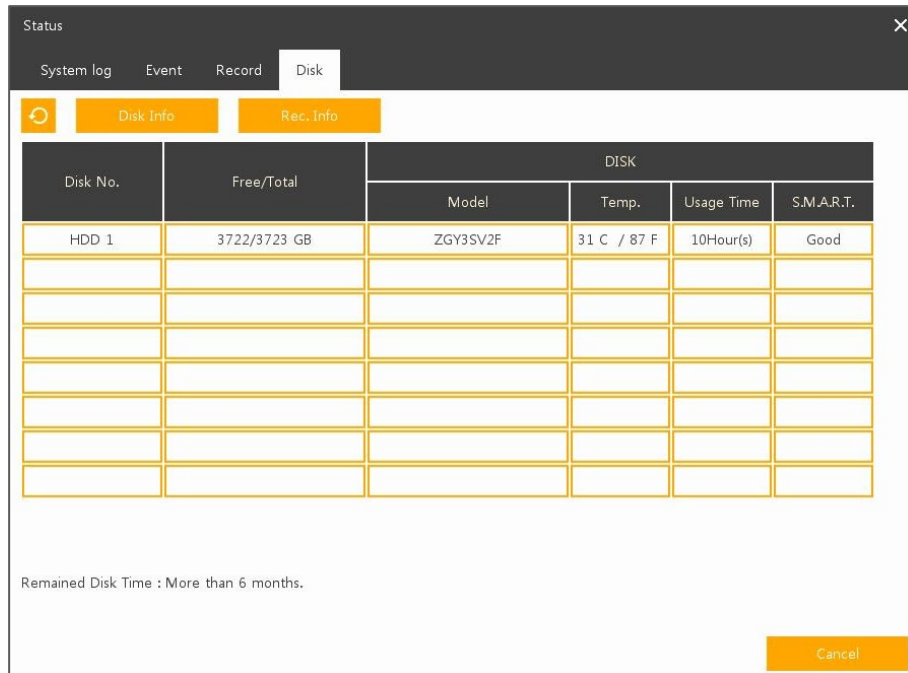

Figure 3-15 Status > Disk in Quick menu

Table 3-14 Status > Disk Item and Description in Quick menu

No.	Item	Description
1	Disk Info	Display disk temperature and S.M.A.R.T information.
2	Rec. Info	Display recording period.
3	Cancel	Completing the status screen.

4. Setup menu

This chapter describes Setup menu in the upper side of the screen.



Figure 4-1 Setup menu

Selecting the menu opens the setting screen.

Note Setup screen is available to click **Setup in** Quick menu by clicking the right button of the mouse.

Table 4-1 Setup menu Item and Description

No.	Item	Description
1	SYSTEM	Setting the system environment.
2	CAMERA	Setting the camera.
3	DEVICE	Setting the non-camera devices connected to the NVR.
4	RECORD	Setting the recording parameters.
5	EVENT	Setting each event.
6	NETWORK	Setting the network environment.

Setup menu includes:

Table 4-2 Setup menu tree

1 Depth	2 Depth	3 Depth
SYSTEM	System	System
		F/W Upgrade
	Time/Date	Time/Date
		Holiday
	Account	User
Configuration	Export/Import	
	Factory Default	
CAMERA	Basic	Basic
		Audio In/Out
	Advanced	Advanced
Registration	Registration	
DEVICE	Display	Display
		OSD
		Sequence

1 Depth	2 Depth	3 Depth
	Disk	Setup
		iSCSI
	PTZ	PTZ
	Serial Device	Serial Device
	Text	Text
	Schedule	Schedule
	Stream	Main Stream
		Sub Stream
Panic		
EVENT	System/Disk	System
		Disk
	Alarm In	Setup
		Schedule
	Motion	Setup
		Schedule
	Video Loss	Setup
	Notification	Periodic
		Schedule
	NETWORK	Basic
PoE Port		
IP Filter		
DVRNS		DVRNS
E-Mail		E-Mail
FTP		FTP
Remote Access		Registration
P2P		P2P
Notification Server		Notification Server
	Notification Message	

4.1 General buttons in Setup menu

This section depicts General buttons in Setup menu.

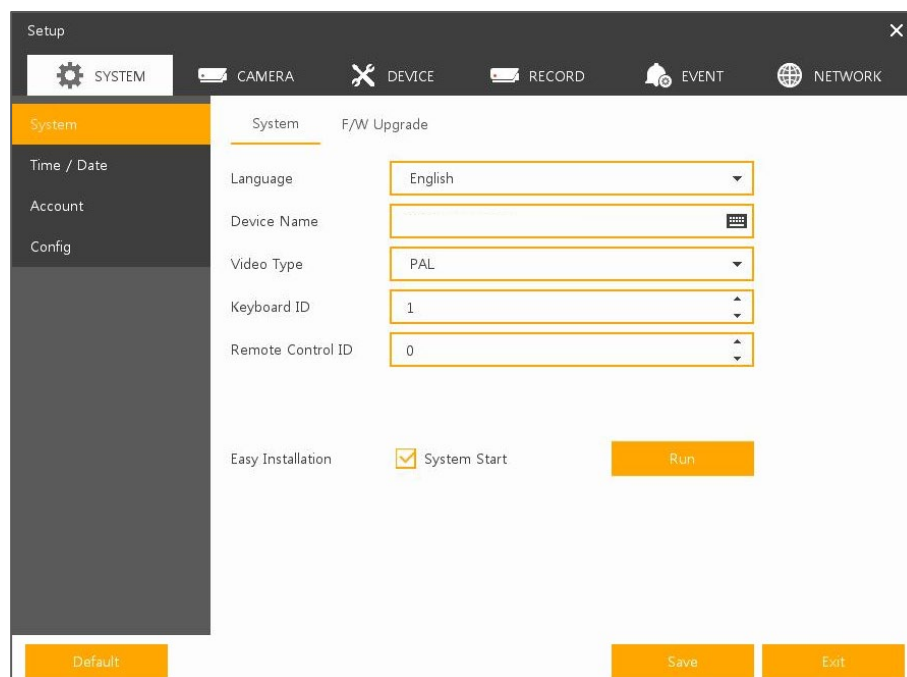

Figure 4-2 General buttons in Setup menu

Table 4-3 Item and Description of General buttons in Setup menu

No.	Item	Description
1	Default	Reverse changed setting value to default in factory.
2	Save	Save the set content.
3	Cancel	Close window.
4	Restore	Cancel the set value, and reverse it to previous value.
5	Apply	Apply the content set.

4.2 SYSTEM

In **SYSTEM**, basic system environment is set.

4.2.1 System

Set and upgrade the basic items of the system.

System > System

Set the basic items in the System.

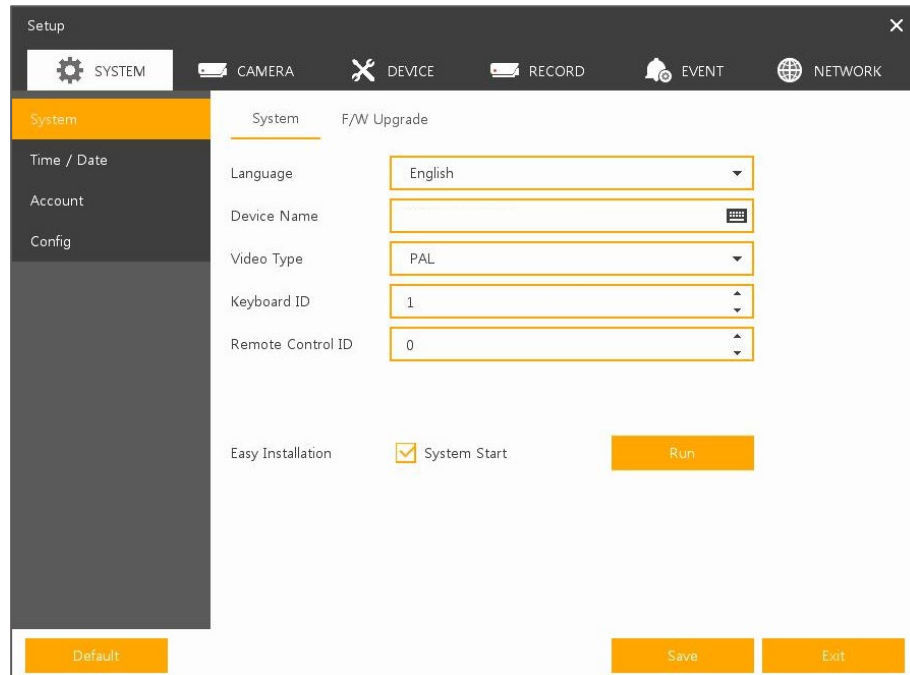

Figure 4-3 SYSTEM > System > System

Table 4-4 SYSTEM > System > System Item and Description

No.	Name	Function
1	Language	Set the system language.
2	Device Name	Enter the device name (Only English is possible).
3	Video Type	Select image standard types (NTSC, PAL).
4	Keyboard ID	Select keyboard ID (1~255).
5	Easy Installation	Select System start to run Easy Installation in starting the system.
6	Run	Run Easy Installation.

Caution If change video type, system will reboot and all setup go to factory default.

System > F/W Upgrade

Set the upgraded items of the system.

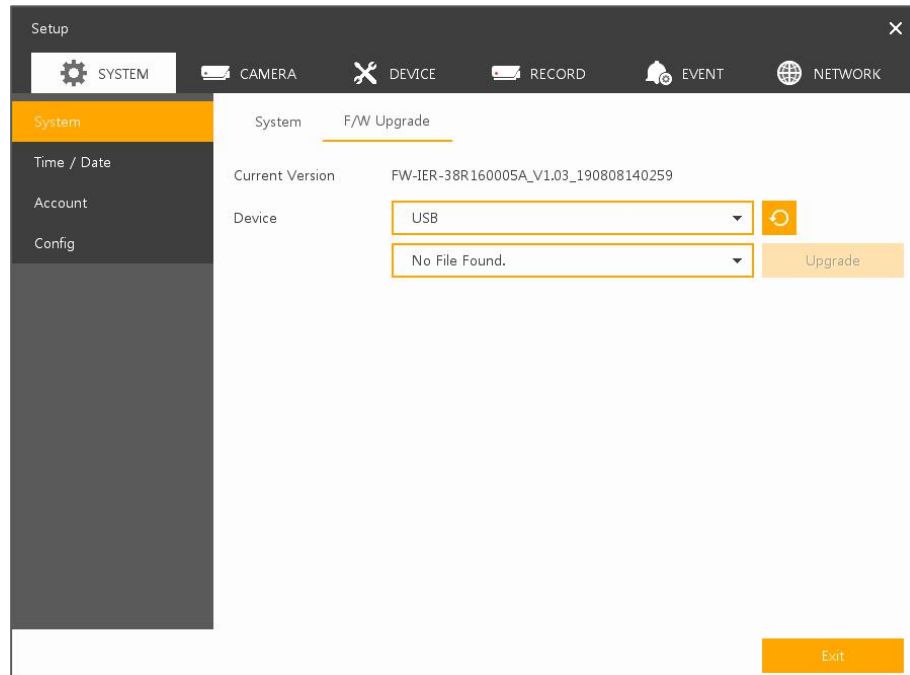

Figure 4-4 SYSTEM > System > F/W Upgrade

Table 4-5 SYSTEM > System > F/W Upgrade Item and Description

No.	Name	Function
1	Current Version	Display the present firmware version.
2	Device	Connect USB memory that has files to upgrade to the USB port, select files to upgrade.

- Note**
- If firmware version in the USB drive is lower than present system version, system does not display the firmware in the USB drive.
 - To upgrade through network, recorder must have HDD.

4.2.2 Time/Date

Set the date, time, and holidays of the system.

Time/Date > Time/Date

Set the date, time, and holidays of the system.

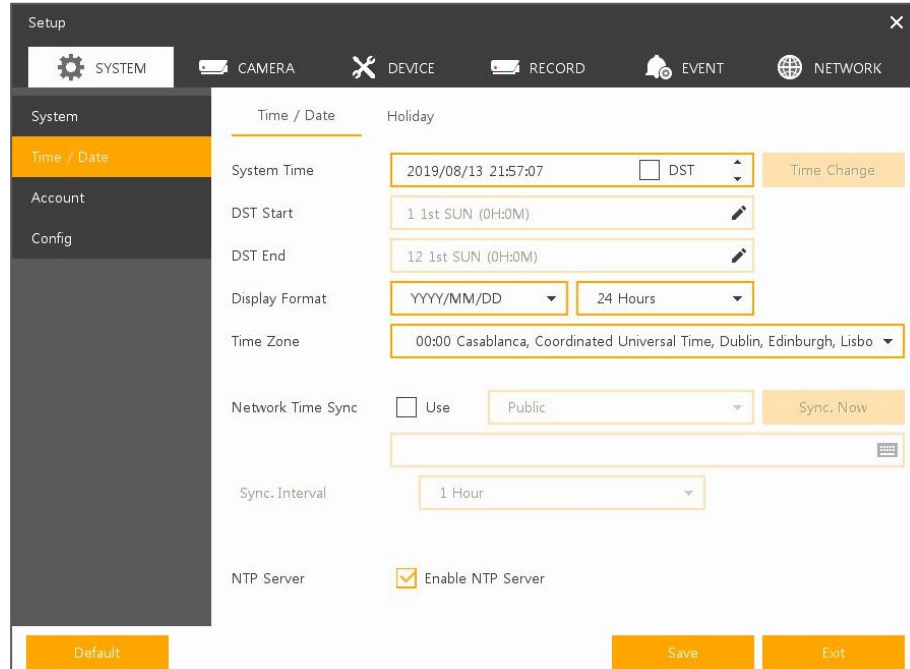

Figure 4-5 SYSTEM > Time/Date > Time/Date

Table 4-6 SYSTEM > Time/Date > Time/Date Item and Description

No.	Name	Function
1	System Time	<p>Set the date and time.</p> <ul style="list-style-type: none"> ▪ DST: Select whether to use summer time. ▪ Time change: Save changed time. <p>If time changed to older time, time overlap list will be created and user can select the list from search and backup menu. Time overlap list can be created up to 20 lists a day.</p>
2	DST Start	Set the starting date of summer time
3	DST End	Set the ending date of summer time
4	Display Format	Select the format to present date and time.
5	Time Zone	Select time zone.
6	Network Time Sync	<p>For using a specific network time server, click the Use checkbox and enter the server address.</p> <ul style="list-style-type: none"> ▪ Sync. Interval: Select synchronization period (1~7-hour) ▪ Last Sync. Time: Displaying the final synchronized time
7	NTP Server	System run NTP(Network Time Protocol) server for NTP client.

Time/Date > Holiday

Set holidays of the system.

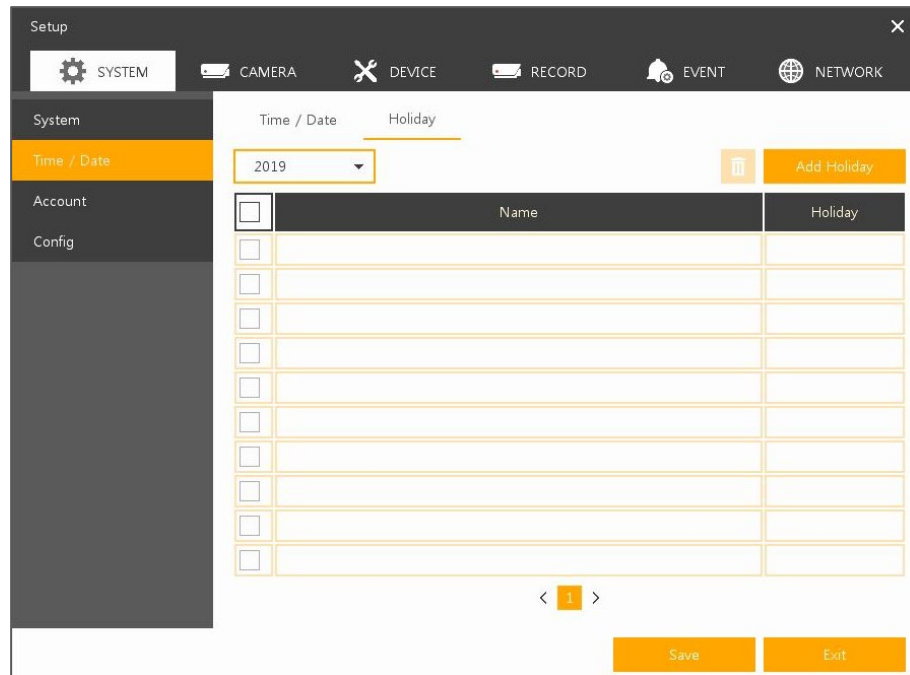



Figure 4-6 SYSTEM > Time/Date > Holiday

Table 4-7 SYSTEM > Time/Date > Holiday Item and Description

No.	Name	Function
1	Year	Select years to set holidays.
2		Delete selected holidays.
3	Add Holiday	Add holidays.
4	List	Display added holiday lists.

Clicking **Add Holiday** displays holiday addition screen like below.

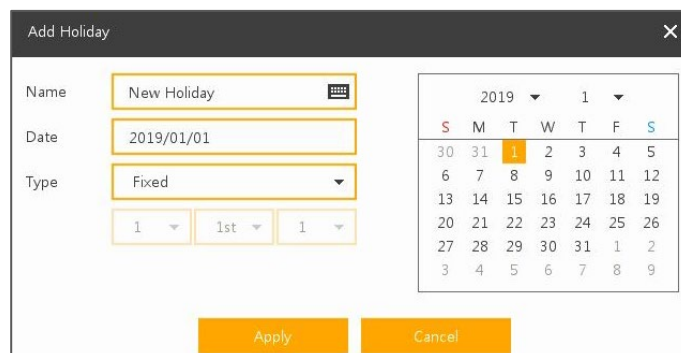

Figure 4-7 SYSTEM > Time/Date > Holiday > Add Holiday

Table 4-8 SYSTEM > Time/Date > Holiday > Add Holiday Item and Description

No.	Name	Function
1	Name	Enter the holiday name.

No.	Name	Function
2	Date	Display chosen date.
3	Type	Select the holiday types. e.g.,) Selecting Relative and 1, first , and Sun , which designates annual January of the 1 st Sunday as a holiday.
4	Calendar	Select the holiday to add.

4.2.3 Account > User

Set the user's account of the system.

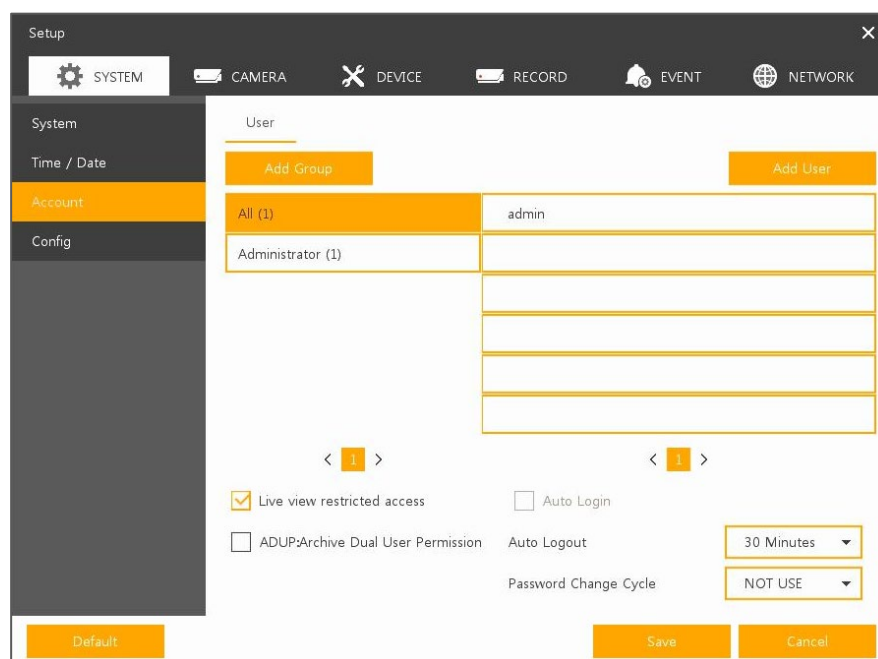

Figure 4-8 SYSTEM > Account > User

Table 4-9 SYSTEM > Account > User Item and Description

No.	Name	Function
1	Add Group	Add users' group.
2	Add User	Add users.
3	Group List	Display a total group list.
4	User List	Display user lists across groups.
5	Live view restricted access	Do not display live video if log it out.
6	ADUP(Archive Dual User Permission)	Two users should access to search, playback and back-up. The user should have administrator permission.
7	Auto Login	When a user selected, Auto Login menu will be activated and if click Auto Login check box, system will be auto login to the selected user.
8	Auto Logout	Select automatic logout time (Null, 1 min, 2 min, 3 min, 4 min, 5 min, 6 min, 7 min, 8 min, 9 min, 10 min, and 30 min).

No.	Name	Function
9	Password Change Cycle	If enable, user should change the password periodically.

Four-eye principle

- In order to access or export video data, two users must log on to the device with their credentials one after the other. This may be one employee and the company's data protection officer, for example (according to Art. 32 GDPR).

GDPR

Password change cycle & automatic logout during inactivity

- If someone forgets to log out ...
- ... so that passwords are changed regularly! (according to Art. 32 GDPR)

GDPR

Press **Add Group** button, then **Add Group** screen displays.

Figure 4-9 SYSTEM > Account > User > Add Group

Table 4-10 SYSTEM > Account > User > Add Group Item and Description

No.	Name	Function
1	Name	Enter the group name.
2	PERMISSION	Select items to permit access.
3		Select channels to permit access.

Differentiated authorization management

GDPR

- Different user groups with different authorizations can be created in the configuration menu. Camera selection for each user. Individual group configuration. Maintenance user without video access (e.g. for installers) (according to Art. 32 GDPR).

Press **Add User** button, then **Add User** screen displays.

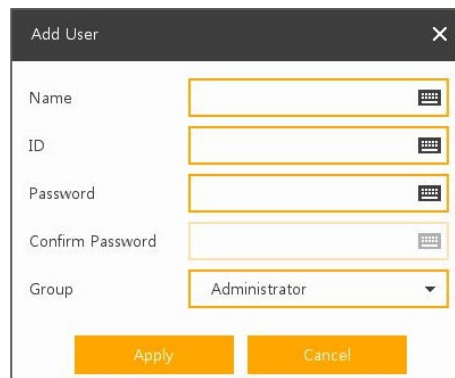

Figure 4-10 SYSTEM > Account > User > Add User

Table 4-11 SYSTEM > Account > User > Add User Item and Description

No.	Name	Function
1	Name	Enter the user name.
2	ID	Enter the user ID.
3	Password	Enter the password.
4	Confirm Password	Confirm the password.
5	Group	Select to the group to which belongs.

4.2.4 Config (Configuration)

Set Export/Import and Factory Default of the system.

Config > Export/Import

Through a save medium, users may apply information set to other devices identically.

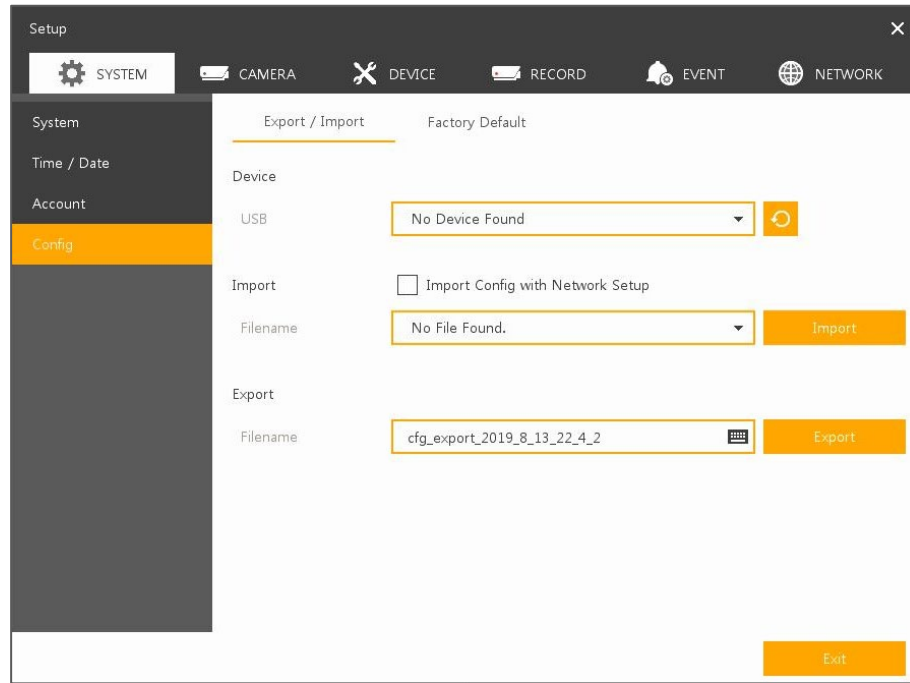

Figure 4-11 SYSTEM > Config > Export/Import

Table 4-12 SYSTEM > Config > Export/Import Item and Description

No.	Name	Function
1	Device	<p>Select an exterior connector with USB.</p> <ul style="list-style-type: none"> USB: Displays the USB device connected. Refresh button: Re-recognize the device.
2	Import	<p>Apply information saved in USB to the device.</p> <ul style="list-style-type: none"> Import Config with network setup: The network setting information is brought from the setting information. Import button: The file in USB is brought to the designated device.
3	Export	<p>Save the set information in the USB.</p> <ul style="list-style-type: none"> Export Config with network setup: Save the information including network setting one from the setting information to be exported. <p>Export button: Save the set information in the USB.</p>

Config > Factory Default

Default the setting value of the device.

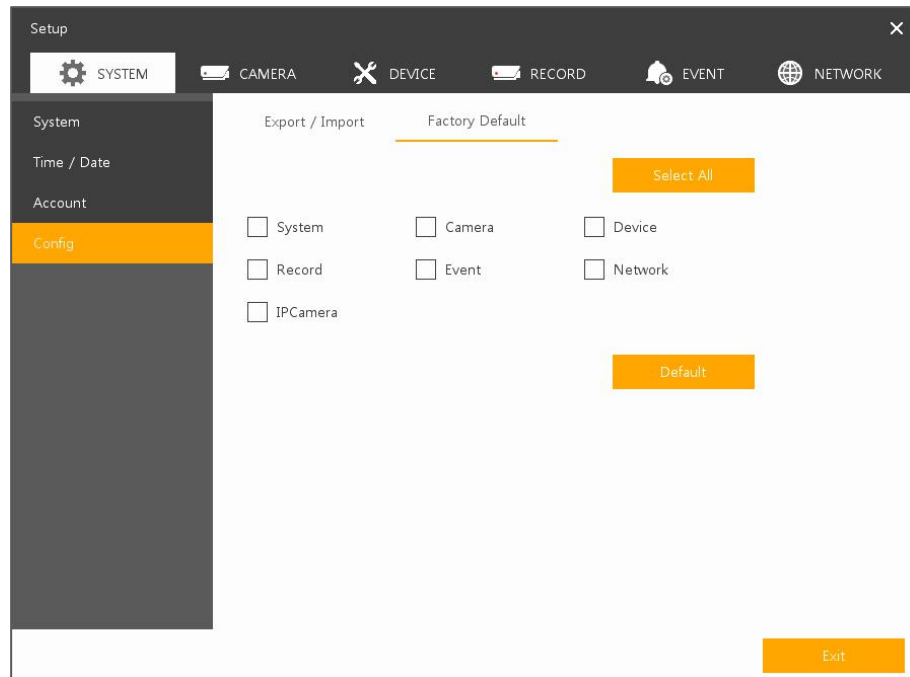

Figure 4-12 SYSTEM > Config > Factory Default

Table 4-13 SYSTEM > Config > Factory Default Item and Description

No.	Name	Function
1	Select All /Unselect All	Select/deselect all items to be defaulted.
2	Default Item	Select/deselect related items to be defaulted.
3	Default button	Default the system to the basics.

4.3 CAMERA

In **CAMERA** section, set the camera to be connected with the device.

4.3.1 Basic

Set the fundamental functions of camera and audio.

Basic > Basic

Set the basic items of camera by channels.

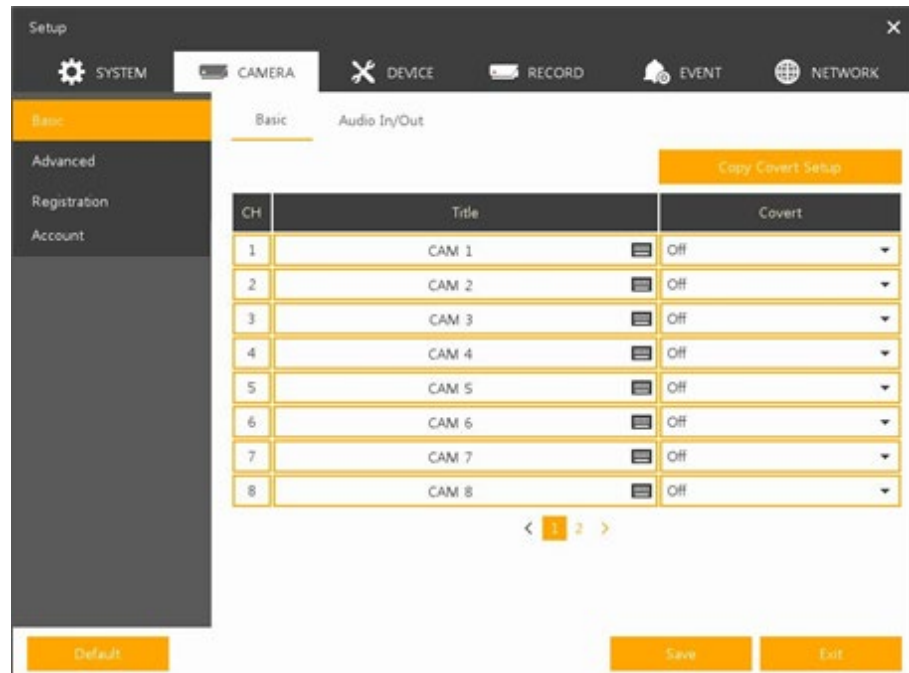

Figure 4-13 CAMERA > Basic > Basic

Table 4-14 CAMERA > Basic > Basic Item and Description

No.	Name	Function
1	CH	Display the channel name.
2	Title	Enter the camera name of relevant channels.
3	Covert	Select images to be shown in the Live screen by channels and whether to mark a status message or not (OFF, Video Only, Video and Text).
4	Copy Covert Setup	In Covert, set items can be duplicated to other channels.

Press **Copy Covert Setup** button, then **Copy Covert Setup** screen displays.

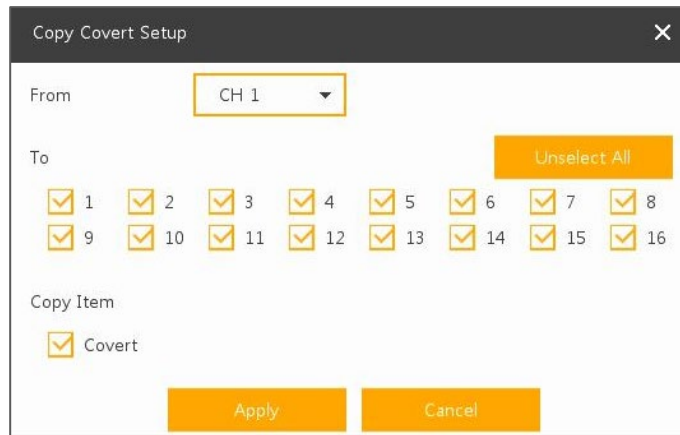

Figure 4-14 CAMERA > Basic > Basic > Copy Covert Setup

Table 4-15 CAMERA > Basic > Basic > Copy Covert Setup Item and Description

No.	Name	Function
1	From	Select a channel converted setting.
2	To	Select a channel to be copied.
3	Select All /Unselect All	Select/deselect all channels.

Basic > Audio In/Out

How to set audio of camera across channels

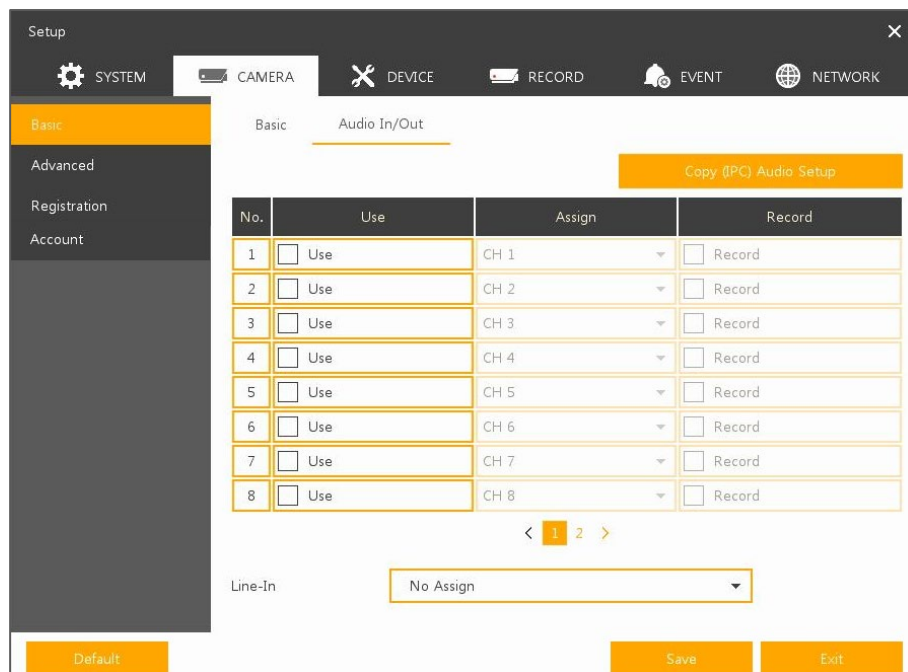

Figure 4-15 CAMERA >Basic > Audio In/Out

Table 4-16 CAMERA > Basic > Audio In/Out Item and Description

No.	Name	Function
1	No.	Display channels of audio

No.	Name	Function
2	Use	Select/deselect whether to use audio.
3	Assign	Select channels to be assigned audio.
4	Record	Select/deselect whether to save audio.
5	Line-In	Assign recorder line in to camera channel. IP camera audio will be disabled.

4.3.2 Advanced

As advanced function of camera, users can set privacy.

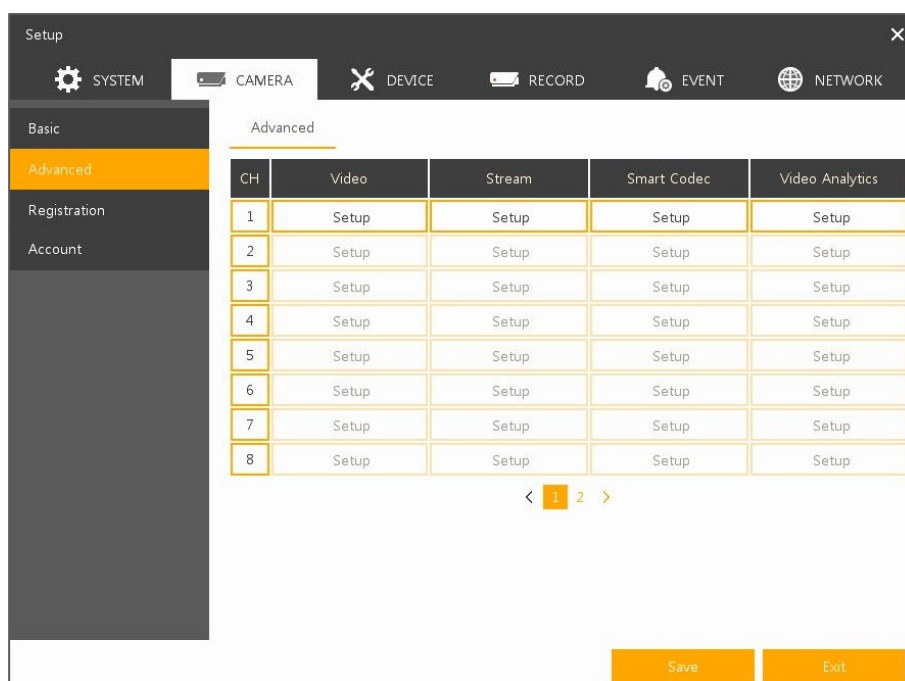

Figure 4-16 CAMERA > Advanced

Table 4-17 CAMERA > Advanced Item and Description

No.	Name	Function
1	CH	Display channels.
2	Video	Setup camera image such as Color, White Balance, WDR, AE and etc.
3	Stream	Setup camera stream such as Resolution, Framerate, Bitrate and etc.
4	Smart Codec	Setup Smart Codec function if camera supports this function.
5	Video Analytics	Setup Video Analytics function if camera support this function.

Video Setup



Figure 4-17 CAMERA > Advanced > Video Setup

Table 4-18 CAMERA > Advanced > Video Setup Item and Description

No.	Name	Function
1	CH	Display channel.
2	Init.	Initialize setting value.
3	Brightness, Saturation, Contrast, Sharpness, White Balance	Change camera image settings. The setting range varies depending on the connected camera. For details, refer to the connected camera manual.
7	Backlight Compensation	Enable or disable BLC function.
9	Wide Dynamic Range	Enable or disable WDR function.
10	IR Cut Filter	Select Day&night control type. The setting value may differ depending on the connected camera. For details, refer to the camera manual.
11	Auto Focus	Sets Auto focus mode on zoom camera. For details, refer to the connected camera manual.
12	Exposure	Sets Exposure mode. For details, refer to the connected camera manual.
13	Fisheye Filter	Click to use Fisheye View menu.

Stream Setup

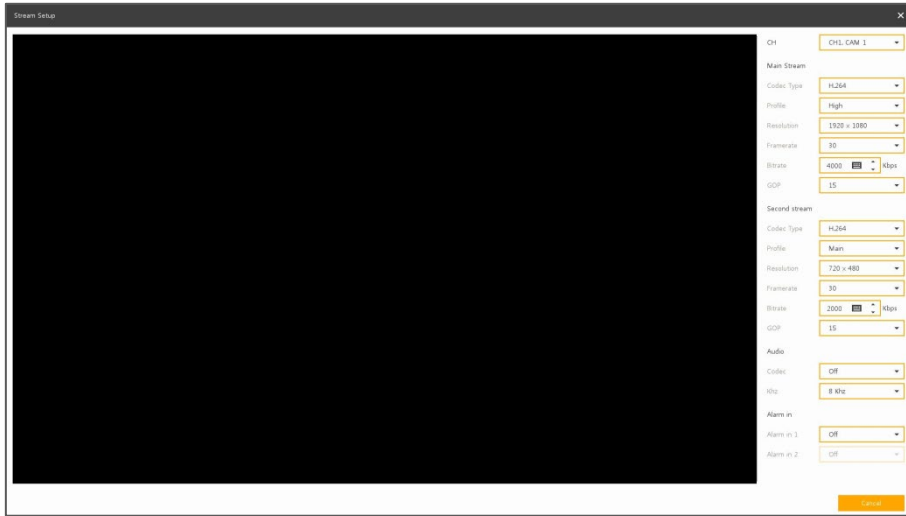

Figure 4-18 CAMERA > Advanced > Stream Setup

Table 4-19 CAMERA > Advanced > Stream Setup Item and Description

No.	Name	Function
1	CH	Display channel.
2	Main Stream	Sets Codec type, Profile, Resolution, Framerate, Bitrate, GOP of Main stream. The values that can be set depend on the connected camera. For details, refer to the connected camera manual.
3	Sub Stream	Sets Codec type, Profile, Resolution, Framerate, Bitrate, GOP of Sub stream. The values that can be set depend on the connected camera. For details, refer to the connected camera manual.
4	Audio	Enable or disable Audio setup. Codec type and frequency depend on the connected camera.
5	Alarm In	Sets Alarm in type as NO(Normally Open) or NC(Normally Close).

Video Analytics Setup



Figure 4-19 CAMERA > Advanced > Video Analytics Setup

Table 4-20 CAMERA > Advanced > Video Analytics Setup Item and Description

No.	Name	Function
1	CH	Display channel.
2	Mode	Select whether to use this function in the NVR.
3	Enable Video Contents Analysis	Select to activate the VCA menu on the camera.

- Note**
- The Video Analytics(VA) menu is displayed only when a camera with VA function is connected..
 - The setting contents differ depending on the connected camera. For details, refer to the camera manual.

Smart Codec Setup

The Smart Codec function allows reduce bandwidth by using compression and frame rate control.

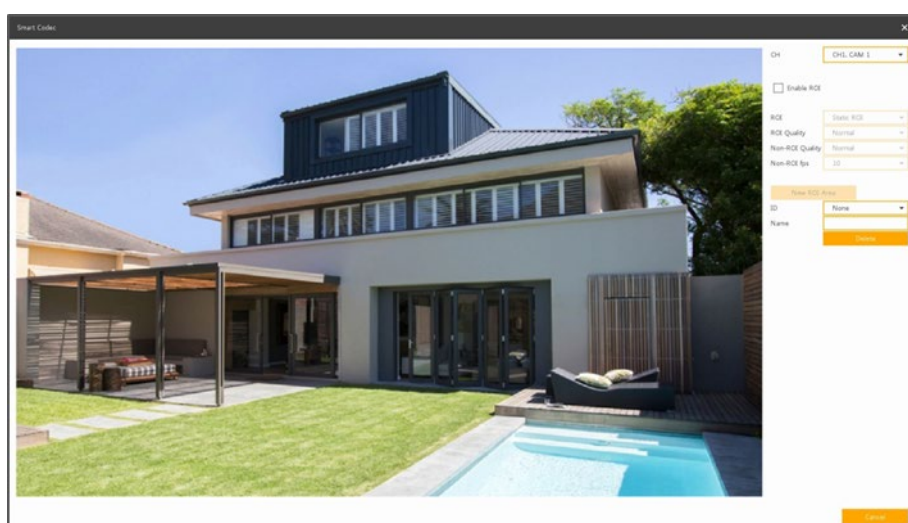

Figure 4-20 CAMERA > Advanced > Smart Codec Setup

Table 4-21 CAMERA > Advanced > Smart Codec Setup Item and Description

No.	Name	Function
1	CH	Display channel.
2	Enable ROI	Select to activate Hi-Stream function. Video mode will be fixed to CVBR.
3	ROI	Select Static ROI or Dynamic ROI. Static ROI is controlled based on the selected area. Dynamic ROI is controlled based on the entire area.
4	ROI Quality	Set quality of the selected area.
5	Non-ROI Quality	Set quality of the non-selected area.
6	Non-ROI fps	Set frame rate of the non-selected area.
8	New ROI Area	Click to create ROI area.

- Note**
- The Smart Codec menu is displayed only when a camera with Smart Codec function is connected.

4.3.3 Registration

As registration function of camera, users can set IP camera registration.

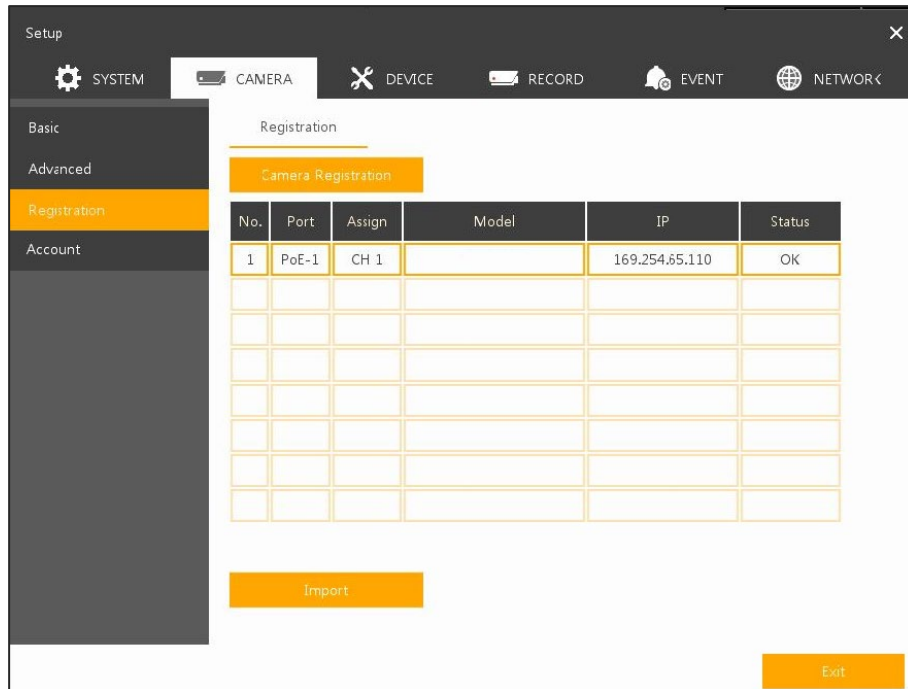

Figure 4-21 CAMERA > Registration

Table 4-22 CAMERA > Registration Item and Description

No.	Name	Function
1	Camera Registration	Register IP Camera. See "3.3.2 Camera Registration" to display detailed information about the camera registration.
2	Registration list	Displays the status of the currently registered IP camera.
3	Import	Register IP camera using text file format.

Click the **Import** button to open the Import window as shown blow.



Figure 4-22 CAMERA > Registration > Import

Table 4-23 CAMERA > Registration > Import Item and Description

No.	Name	Function
1	Import USB	Check the USB device is connected. If you connect a USB device with pop-up window open, click  button to rescan.

No.	Name	Function
2	File Name	Enter the file name include extension to import the IP camera list.
3	Import	Import the camera list.
4	Connect	Register the IP cameras based on the information from the list.

Note The contents of the IP camera list are written in the following order.
Channel number, IP address, ID, Password, Device service address, Web port,
Camera title.
Ex) 1,192.168.0.8,admin,admin,http://192.168.0.8/onvif/device_service,80,CAM1

Attention

- After importing, you need to click **Connect** to read the camera information and register the camera.
- When creating IP camera list, the encoding method should be saved in UTF-8 formation.

4.3.4 Account

As registration function of camera, users can set IP camera account.

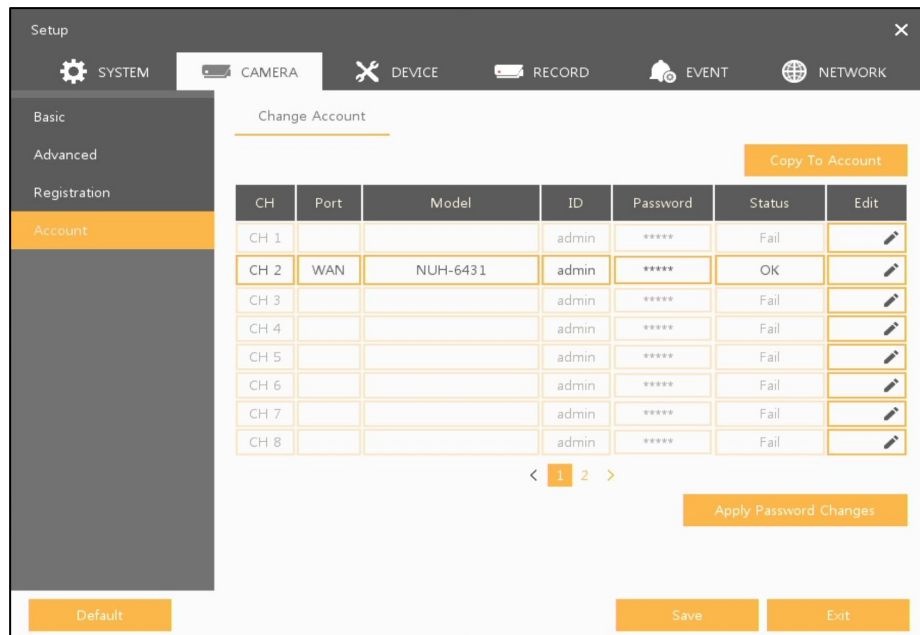

Figure 4-23 CAMERA > Account

Table 4-24 CAMERA > Account

No.	Name	Function
1	Copy To Account	Used to copy account information or IP-CAM account information for access.
2	Account List	Display a total account list.
3	Apply Password Changes	This button to change your password.

Press **Copy To Account** button, then **Copy To Account** screen displays.

Figure 4-24 CAMERA > Account > Copy To Account

Table 4-25 CAMERA > Account > Copy To Account

No.	Name	Function
1	From	Select a channel converted setting.
2	To	Select a channel to be copied.
3	Select All /Unselect All	Select / unselect all channels.

Press  button, then **Edit Account: IP CAMERA** screen displays.

Figure 4-25 CAMERA > Account > Account List

Table 4-26 CAMERA > Account > Account List

No.	Name	Function
1	ID	Enter ID of account
2	Password	Enter Password of account
3	Confirm Password	Enter Confirm Password of account

Note If the password change is successful, the edit entry in the list displays "OK"
If password change fails, edit entries in the list show "Fail"

Caution Expose warning window when entering a vulnerable password on the virtual keyboard.

Press **Apply Password Changes** button, then **Apply Password Changes** screen displays.

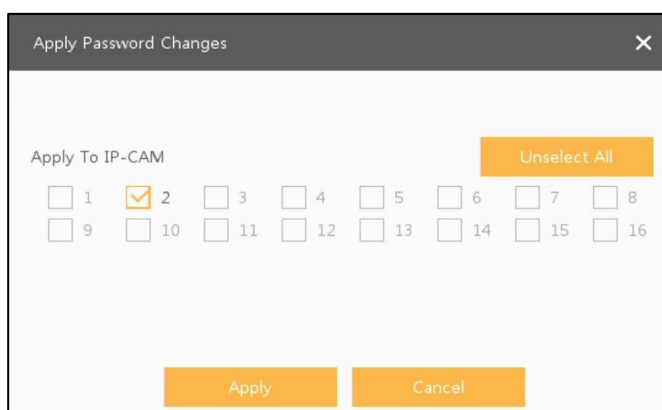

Figure 4-26 CAMERA > Account > Apply Password Changes

Table 4-27 CAMERA > Account > Apply Password Changes

No.	Name	Function
1	Apply To IP-CAM	Select a channel converted setting.
2	Select All /Unselect All	Select / unselect all channels.

4.4 DEVICE

In **DEVICE**, set the device to connect with the unit.

4.4.1 Display

Set matters related to a display device and live screen.

Display > Display

Set the display device.

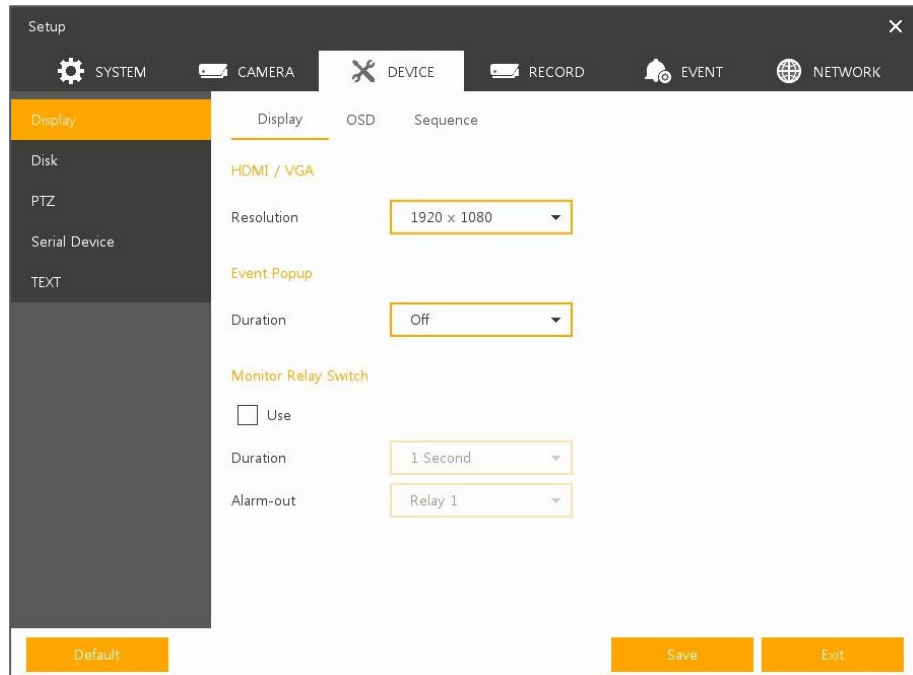

Figure 4-27 DEVICE > Display > Display

Table 4-28 DEVICE > Display > Display Item and Description

No.	Name	Function
1	HDMI/VGA	Select the resolution of the display device (1024x768, 1280x720, 1920x1080, and 3840x2160).
2	Event Popup	Set duration of event popup screen. Screen go back to original layout after duration time
3	Monitor Relay Switch	Select whether to use monitor alarm. When channel change or split mode change of live screen, alarm is generated by selected alarm output.



Caution

- VGA port does not support 3840x2160 resolution.
- If resolution is set to 3840x2160 and a monitor that does not support this resolution is connected to the HDMI port, it will automatically change to 1024x768 resolution.

Display > OSD

Set the OSD of the display device.

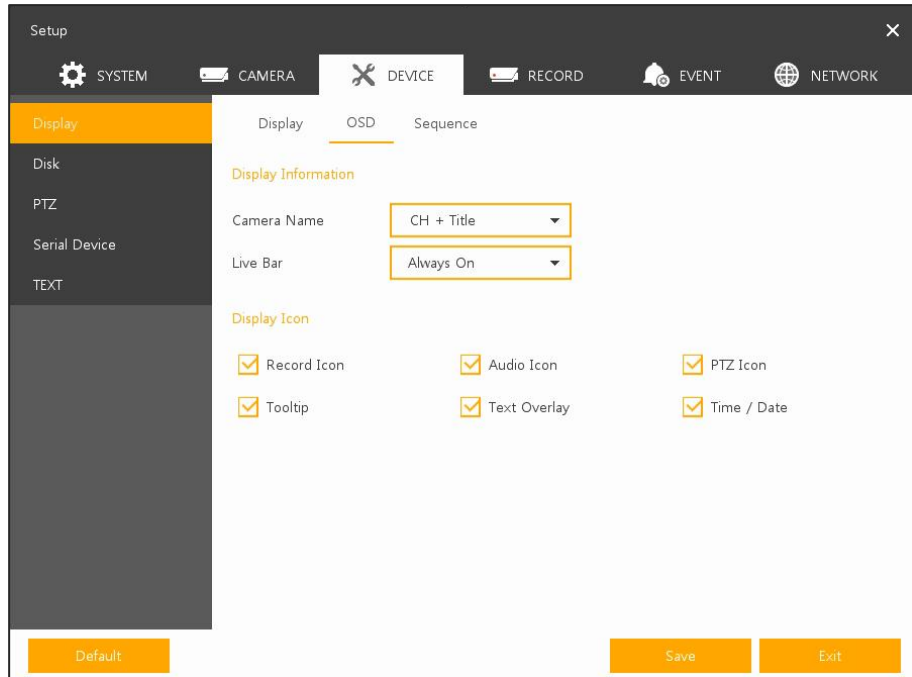

Figure 4-28 DEVICE > Display > OSD

Table 4-29 DEVICE > Display > OSD Item and Description

No.	Name	Function
1	Camera Name	Select the way to display camera in live screen (Off, CH+Title, CH, Title).
2	Live Bar	Select the way to display the live bar (Always On, Auto Hide).
3	Display Icon	Select/deselect icons to display in the live screen.

Display > Sequence

How to set the play sequence of live screen

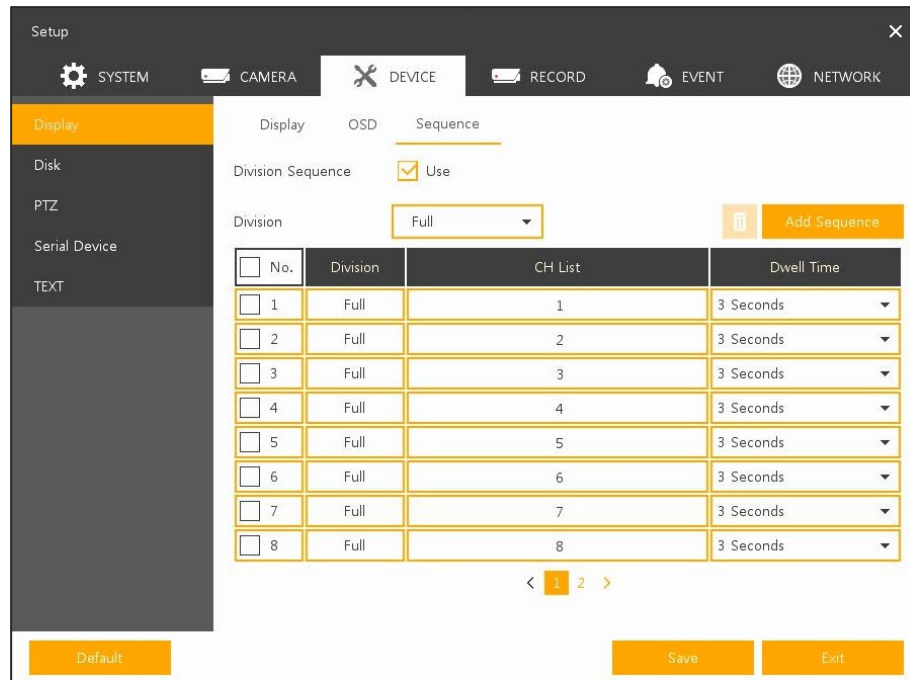



Figure 4-29 DEVICE > Display > Sequence

Table 4-30 DEVICE > Display > Sequence Item and Description

No.	Name	Function
1	Division Sequence	Set to convert automatically as 4-partition screen on the time basis.
2	Division	Select screen partition mode to be marked in the below table (Full, Quad and 3x3).
3	Sequence List	Display the sequence list based on division selected value.
4	Add Sequence	Add items to be included in the play sequence.
5	No.	Automatically controvert screens in number order.
6	Division	Displays as full, Quad and 3x3.
7	CH List	Set automatic conversion CHs. In case of choosing CH3 in No. 1, CH3 is shown in advance.
8	Dwell Time	Set the remaining time for automatic conversion (3 sec~30 sec)
9	Default	Reverse to changed set value in default.
10		Revise the list.
11		Delete the list.

Clicking **Add Sequence** displays **Add Sequence** screen.

The screenshot shows a dialog box titled "Add Sequence" with a close button (X) in the top right corner. Inside the dialog, there are three dropdown menus: "Dwell Time" with "3 Seconds" selected, "Division" with "Full" selected, and "Channel Selection" with "CH 1" selected. At the bottom of the dialog, there are two buttons: "Apply" and "Cancel".

Figure 4-30 DEVICE > Display > Sequence > Add Sequence

Table 4-31 DEVICE > Display > Sequence > Add Sequence Item and Description

No.	Name	Function
1	Dwell Time	Select time to play (3 sec, 5 sec, 10 sec, 15 sec, and 30 sec).
2	Division	Select the partition screen to play.
3	Channel Selection	Select channels to play.

4.4.2 Disk > Setup

Disk > Setup

The way to set the disk

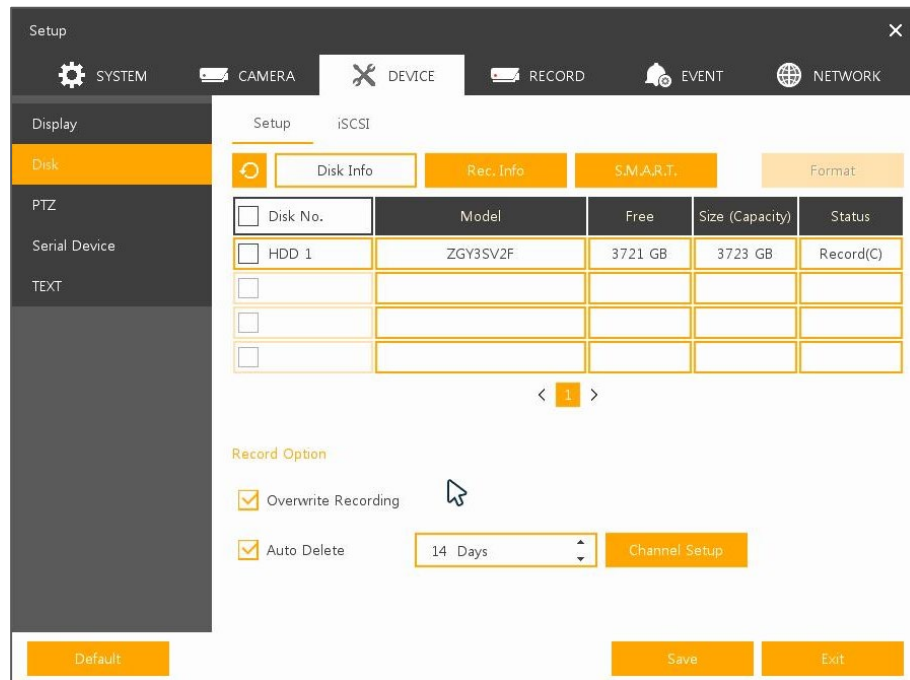

Figure 4-31 DEVICE > Disk > Setup

Table 4-32 DEVICE > Disk > Setup Item and Description

No.	Name	Function
1		Refresh disk information.
2	Disk Info	Display the basic disk information in disc list. <ul style="list-style-type: none"> Model: disk model name Free: disk capacity to save Size (Capacity): total disk capacity Status: disk status
3	Rec. Info	Display saved disk information in disc list. <ul style="list-style-type: none"> Start Recording Time: starting time for saving information in the disk End Recording Time: ending time to stop saving information in the disk Status: disk status
4	S.M.A.R.T.	Display S.M.A.R.T. information in disc list. <ul style="list-style-type: none"> Model: disk model name Temp.: disk temperature Usage Time: running time after turning on the disk S.M.A.R.T.: a presenter of disk's malfunction
5	Disk List	Display the disk list select/deselect disc to be formatted
6	Format	Format the disk selected.

No.	Name	Function
7	Overwrite Recording	Select/deselect to rewrite new data on the existing disk in case of insufficient saving space remained
8	Auto Delete	Select/deselect to use the function to delete saved data automatically (1-365 days).

Defined storage times per video channel

- Users can define – for each video channel individually – how long the video material will be stored for. This serves to avoid unintentional violations of the GDPR since video data will be deleted automatically as soon as the purpose of their collection is fulfilled (according to Art. 17 GDPR).

GDPR

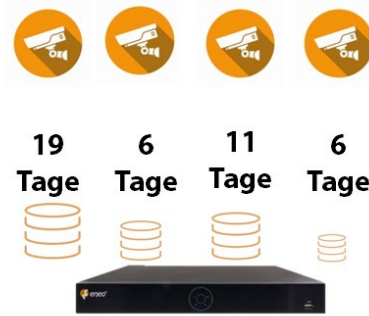
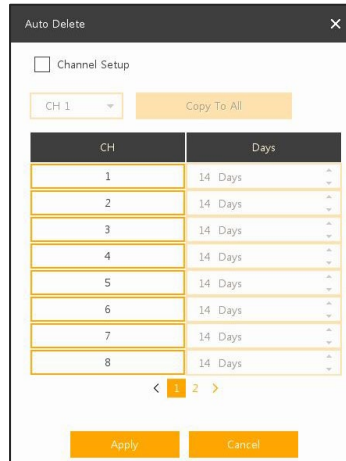

Disk > iSCSI

The way to set the iSCSI

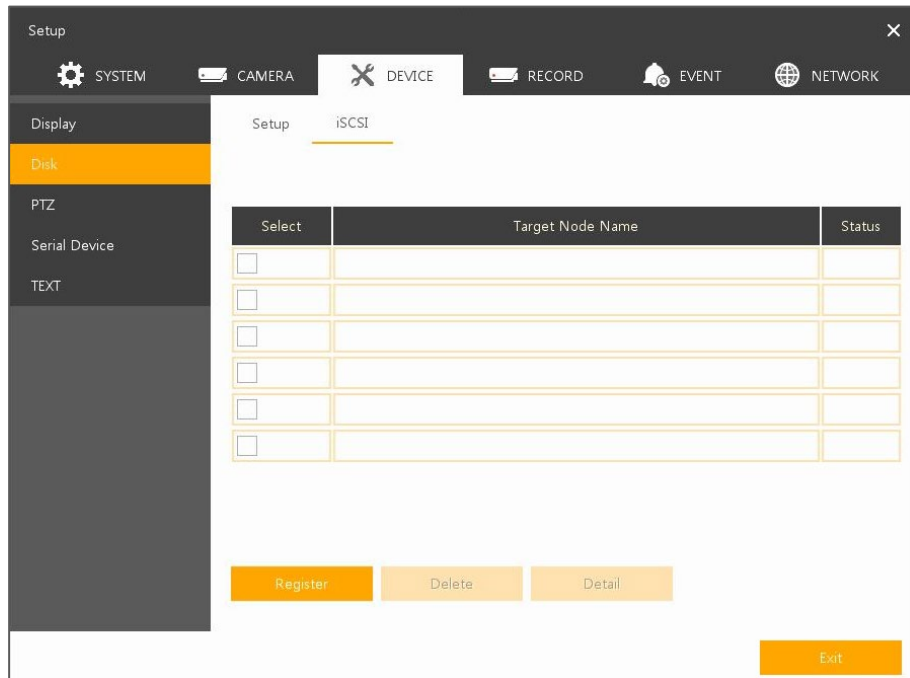

Figure 4-32 DEVICE > Disk > iSCSI

Table 4-33 DEVICE > Disk > iSCSI Item and Description

No.	Name	Function
1	Select	Display iSCSI device number. Up to 6 devices support.
2	Target Node Name	Display registered IQN (iSCSI Qualified Name).
3	Status	Display connection status (Good or Bad).
4	Register	Open iSCSI registration window.
5	Delete	Delete registered iSCSI storage.
6	Detail	Display selected iSCSI IP address and port number.

Note

- Recorder support Max. 6 volumes (Target Node).
- Each volume supports Max. 16TB.

Clicking **Register** displays **iSCSI Register** screen.

Figure 4-33 DEVICE > Disk > iSCSI > Register

Table 4-34 DEVICE > Disk > iSCSI > Register Item and Description

No.	Name	Function
1	Target Address Target Port HTTP Port	Input IP address and ports for Iscsi.
2	Discover	Click to search iSCSI storage.
3	Enable CHAP	Select Enable CHAP if iSCSI use CHAP authentication.
4	User Name	Enter user name of CHAP authentication.
5	Password	Enter password of CHAP authentication.

No.	Name	Function
6	Add	Click to register the discovered iSCSI storage. User can add iSCSI one by one. If recorder does not have any internal HDD, the recorder reboot automatically and complete mounting process.

Note

- If iSCSI file system is different with recorder, it must be formatted.
- If user wants to change recorder IP address, iSCSI must be deleted.
- iSCSI device block size must be set as 512byte.
- iSCSI device IP address must be set as static IP not DHCP.

4.4.3 PTZ > PTZ

To use PTZ Function of the device, users need to match ID, protocol, and speed with each camera.

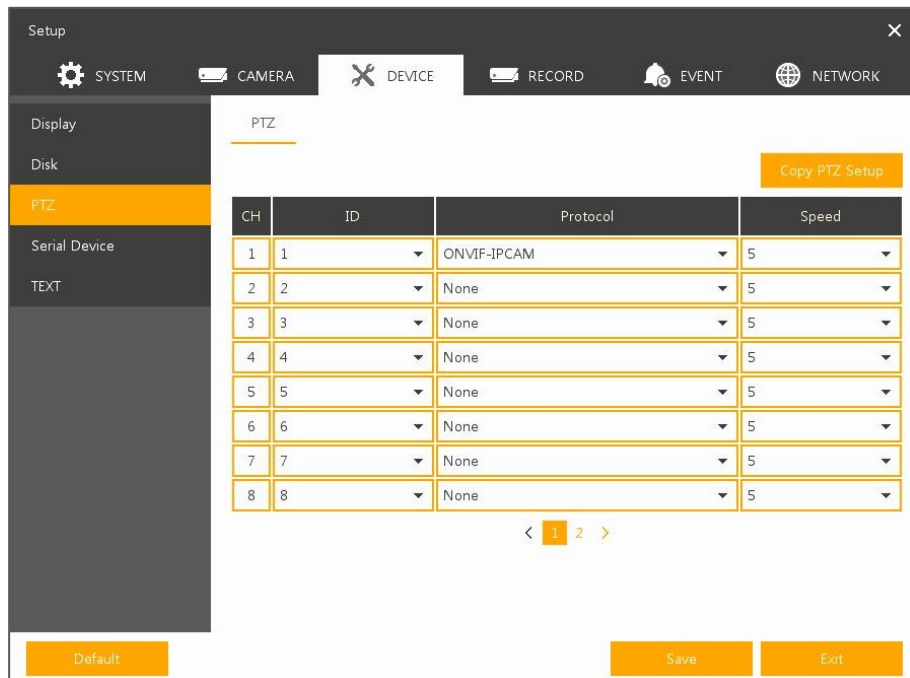

Figure 4-34 DEVICE > PTZ > PTZ

Table 4-35 DEVICE > PTZ > PTZ Item and Description

No.	Name	Function
1	Copy PTZ Setup	Apply setting history to all or selected channels in the same way.
2	CH	Display channels.
3	ID	Select camera ID connected to relevant channels (1-255).
4	Protocol	Select protocol of camera connected to relevant channels.
5	Speed	Select pan-tilt of camera connected to relevant channels (1-8).

Note

- For more information about camera ID, protocol information, and details, sees Instruction of relevant PTZ Function camera.

4.4.4 Serial Device > Serial Device

Users need to set Serial Device to connect PTZ camera, USB device with the unit.

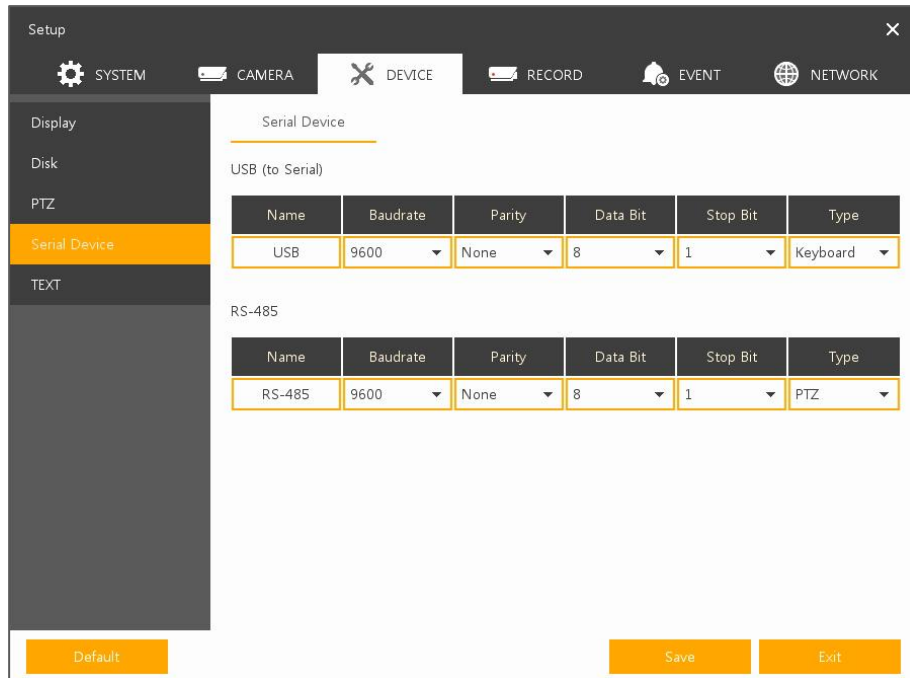

Figure 4-35 DEVICE > Serial Device > Serial Device

Table 4-36 DEVICE > Serial Device > Serial Device Item and Description

No.	Name	Function
1	USB (to Serial)	Set communication transmission value of USB device.
2	RS-485	Set communication transmission value of RS-485 connector.

Set the communication transmission value based on the device to be connected and select the medium (PTZ, keyboard, or Text device).

4.4.5 TEXT > TEXT

Set the input device such as ATM or POS, etc.

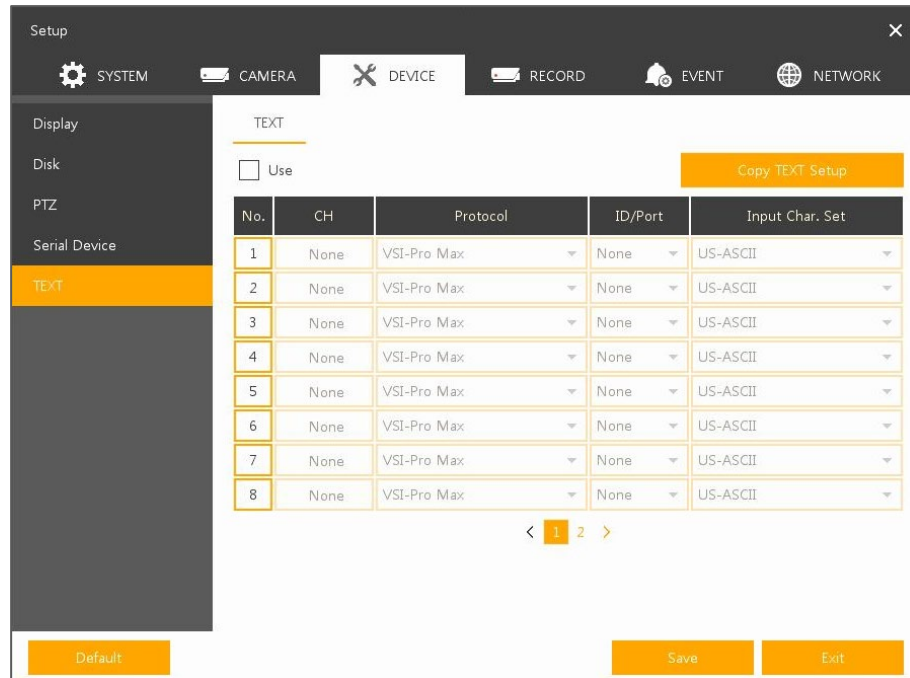

Figure 4-36 DEVICE > TEXT > TEXT

Table 4-37 DEVICE > TEXT > TEXT Item and Description

No.	Name	Function
1	Use	Select/deselect whether to use text function.
2	CH	Select camera channels to connect with the text input device.
3	Protocol	Select protocol to correspond with the text input device.
4	ID/Port	Select ID and port no. to correspond with the text input device.
5	Input Char. Set	Select a character format of the text input device.
6	Copy Text Setup	As for connecting multiple units, duplicate set value to others.

Press **Copy to TEXT Setup** button, then **Copy to TEXT Setup** screen displays.

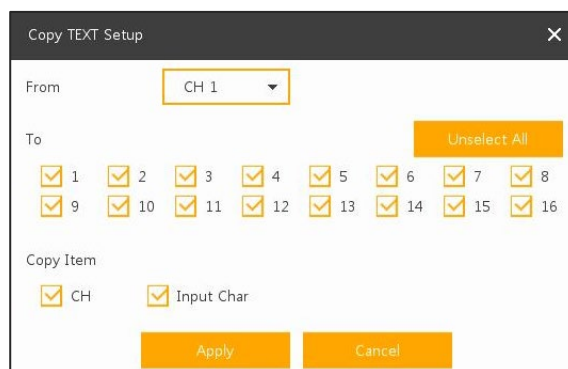

Figure 4-37 DEVICE > TEXT > TEXT > Copy to TEXT Setup

Table 4-38 DEVICE > TEXT > TEXT > Copy to TEXT Setup Item and Description

No.	Name	Function
1	From	Select channels set.
2	To	Select the device to be copied.
3	Select All /Unselect All	Select/unselect all channels.
4	Copy Item	Select/unselect items to be copied.

4.5 RECORD

In **RECORD**, users may set matters related to recording.

4.5.1 Schedule > Schedule

Recording types can be set across channels and time.

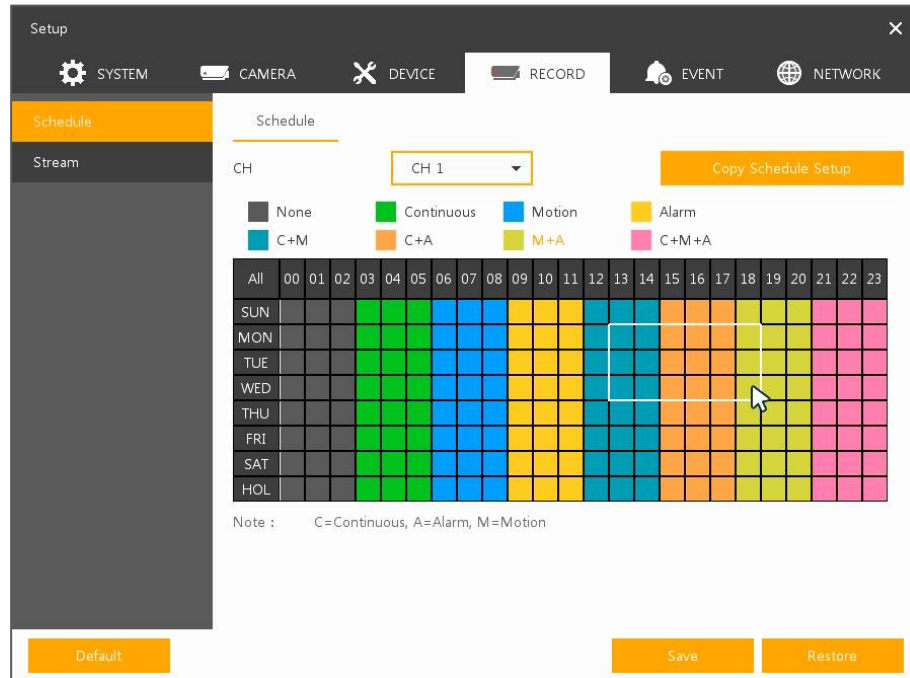









Figure 4-38 RECORD > Schedule > Schedule

Table 4-39 RECORD > Schedule > Schedule Item and Description

No.	Name	Function
1	CH	Select channels to set schedules.
2	Schedule Type Selection	Select the types of schedules.
3	Schedule Table	Display the schedule users set.
4	Drag Field	Display the area dragged with a mouse.
5	Copy Schedule Setup	Copy set recording schedule to other channels.

The function of each scheduling type involves:

Table 4-32 Function of each scheduling type

Color	Scheduling type	Function
	None	Do not record.
	Continuous	Record on consecutive mode when time set.
	Motion	Record on event recording mode when motion sensitive event occurs.
	Alarm	Record on event recording mode when alarm occurs.
	C+M	Record on event recording mode when motion sensitive event occurs during consecutive mode recording.
	C+A	Record on event recording mode when alarm occurs during consecutive mode recording.
	M+A	Record on event recording mode when only alarm and motion sensitive event occur.
	C+M+A	Record on event recording mode when only alarm and motion sensitive event occur during consecutive mode recording.

The way to schedule recording across channels

- 1 Select channels to schedule.



- 2 Select items in scheduling types.



- 3 Position the mouse to the schedule table.

- 4 Drag the area to be scheduled with a mouse.

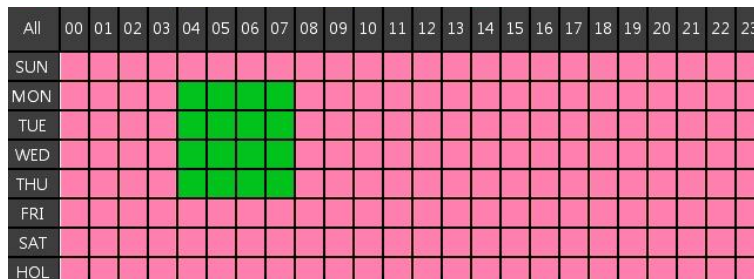

- 5 Selected field is presented as scheduling type colors.

- 6 Click **Copy Schedule Setup** if you want to copy the schedule to other channels.



7 **Copy Schedule Setup** screen displays.



8 Select channels to be copied.



9 Select channels to apply copied content.



10 Copy the schedule by pressing **Apply**.



1 Press **Save** to save the schedule.

4.5.2 Stream

To set the image resolution when event occurs across channels or general recording is in process.

Stream > Main Stream

To set the image quality and resolution of Main Stream

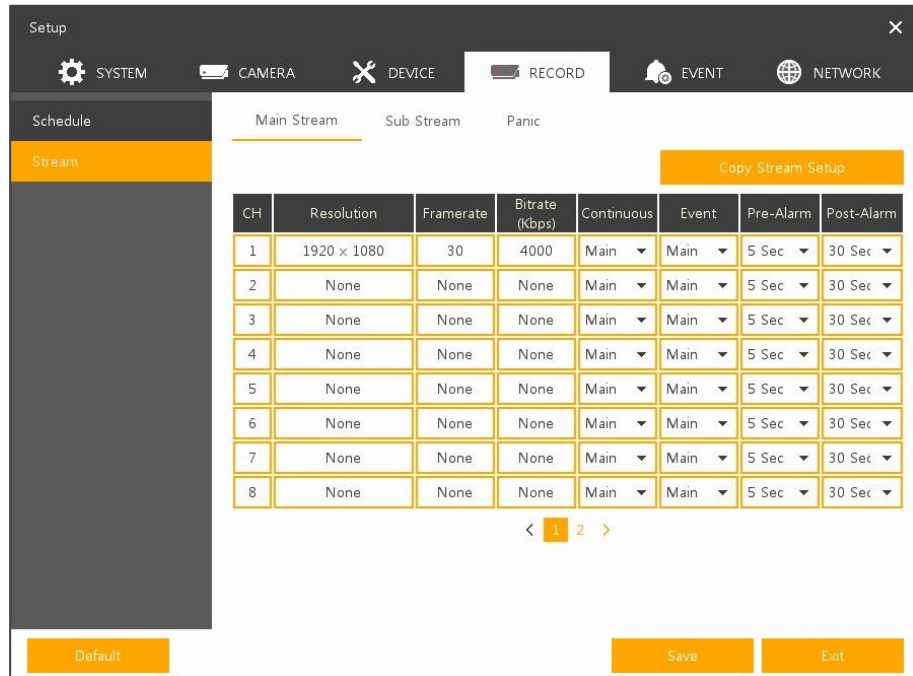

Figure 4-39 RECORD > Stream > Main Stream

Table 4-40 RECORD > Stream > Main Stream Item and Description

No.	Name	Function
1	CH	Display channels.
2	Resolution Framerate Bitrate(Kbps)	Show camera main stream setup status.
3	Continuous	Select recording stream in case of Continuous mode.
4	Event	Select recording stream in case of Event mode.
5	Pre-Alarm	Start recording before set time, if event occurs. (none, 1 sec, 2 sec, 3 sec, 4 sec, and 5 sec)
6	Post-Alarm	Recording after set time until event ends. (5 sec, 10 sec, 30 sec, 1 min, 5 min, 10 min, 30 min, and 1hour)
7	Copy Stream Setup	Copy main recording image set value to other channels.

Clicking **Copy Stream Setup** opens **Copy Stream Setup**.

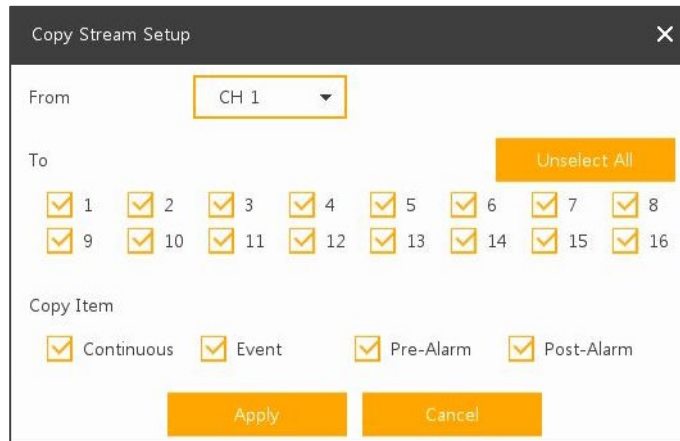

Figure 4-40 RECORD > Stream > Main Stream > Copy Stream Setup

Table 4-41 RECORD > Stream > Main Stream > Copy Stream Setup Item and Description

No.	Name	Function
1	From	Select the channel set.
2	To	Select the device to be copied.
3	Select All /Unselect All	Select/deselect all channels.
4	Copy Item	Select/deselect items to be copied.

Stream > Sub Stream

To set the image quality and resolution of Sub Stream

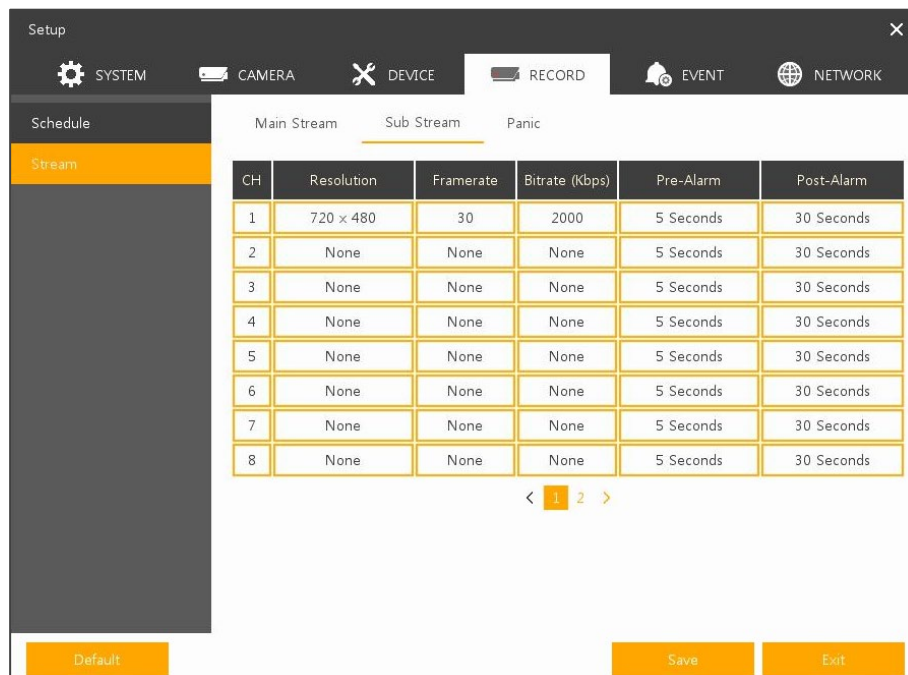

Figure 4-41 RECORD > Stream > Sub Stream

Table 4-42 RECORD > Stream > Sub Stream Item and Description

No.	Name	Function
1	CH	Display channels.
2	Resolution Framerate Bitrate(Kbps)	Show camera second stream setup status.
3	Pre-Alarm	Start recording before set time, if event occurs.
4	Post-Alarm	Recording after set time until event ends.

Stream > Panic

How to set immediate recording

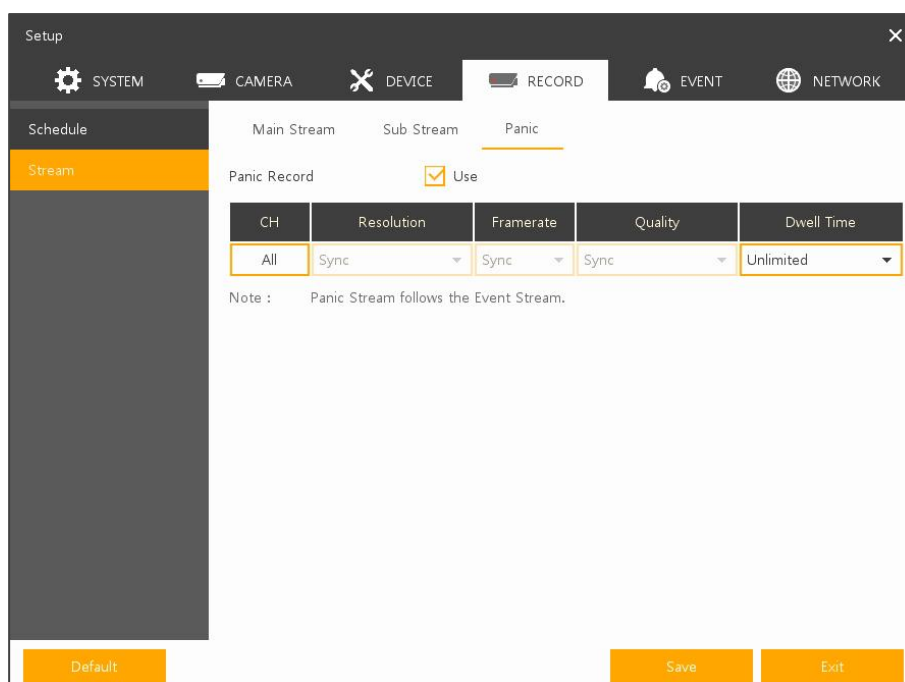

Figure 4-42 RECORD > Stream > Panic

Table 4-43 RECORD > Stream > Panic Item and Description

No.	Name	Function
1	Panic Record	Select/deselect to use immediate recording function.
2	CH	Display channels.
3	Resolution Frame rate Quality	Panic recording stream follows the Event stream.
4	Dwell Time	Select recording duration (Unlimited, 10 sec, 30 sec, 1 min, 5 min, 10 min, and 30 min).

4.6 EVENT

In **EVENT**, users may set each event of the device.

4.6.1 System/Disk

To set the system and disk event

System/Disk > System

To set the system event of the device

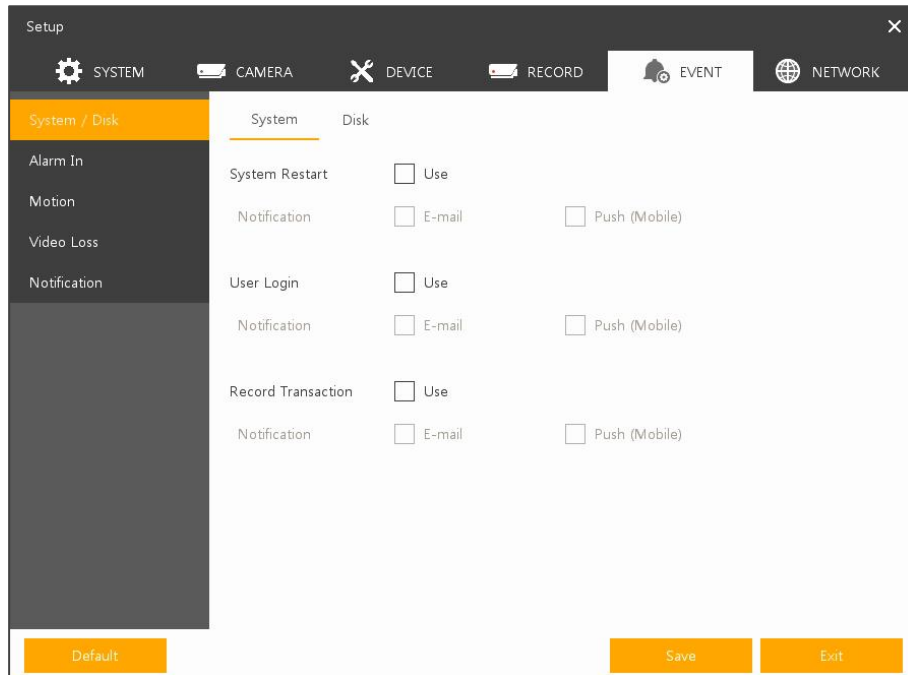

Figure 4-43 Event > System/Disk > System

Table 4-44 Event > System/Disk > System Item and Description

No.	Name	Function
1	System Restart	Select/deselect whether to use system restart event.
2	Notification	Select/deselect whether to use mailing or mobile push in case of event.
3	User Login	Select/deselect whether to use user-login event.
4	Record Transaction	Select/deselect whether to use record transaction event.

System/Disk > Disk

To set disk event

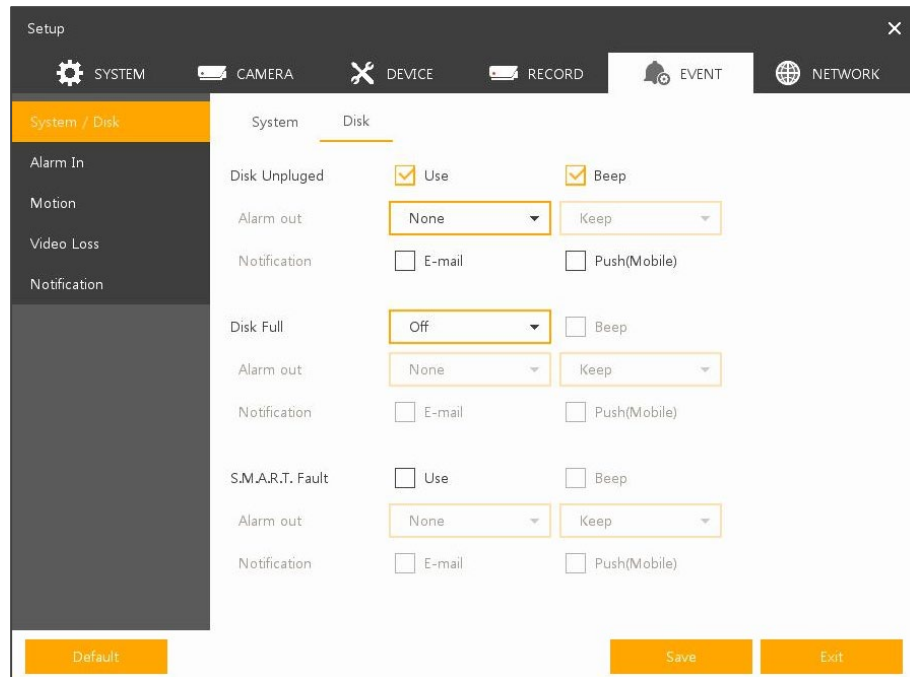

Figure 4-44 Event > System/Disk > Disk

Table 4-45 Event > System/Disk > Disk Item and Description

No.	Name	Function
1	Disk Unplugged	Select/deselect whether to use disk unplugged event
2	Beep	Select/deselect whether to use buzzer sound in case of event.
3	Alarm out	Select to end alarm time (Keep, 5 sec, 10 sec, 20 sec, 30 sec, 1 min, 10 min, 30 min, and 1 hour).
4	Notification	Select/deselect whether to use mailing or mobile push in case of event.
5	Disk Full	Set disk capacity for disk full event (Off, 50%, 60%, 70%, 80%, 90%, and 100%).
6	S.M.A.R.T. Fault	Select/deselect whether to use S.M.A.R.T. Fault event of HDD.

4.6.2 Alarm In

To set sensor alarms and schedule

Alarm In > Setup

To set sensor alarms

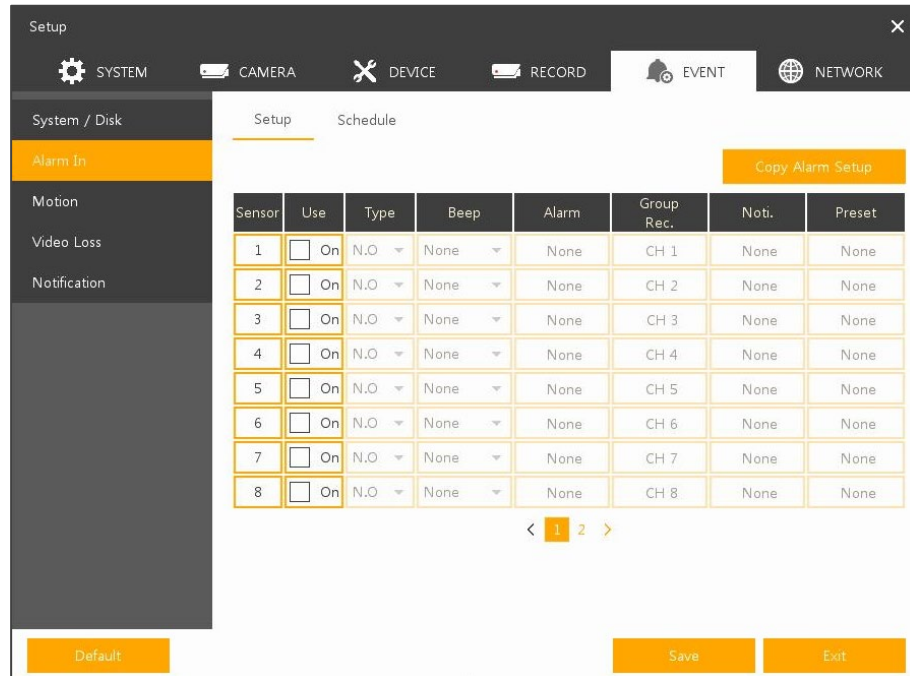

Figure 4-45 Event > Alarm In > Setup

Table 4-46 Event > Alarm In > Setup Item and Description

No.	Name	Function
1	Sensor	Display sensor numbers.
2	Use	Select/deselect whether to use alarm in the sensor.
3	Type	Select sensor types (N.O, N.C, NET). <ul style="list-style-type: none"> ▪ N.O: Normally Open ▪ N.C: Normally Close ▪ NET: Select when using the camera's alarm input function.
4	Beep	Select use time of buzzer sound (null, 5 sec, 10 sec, 20 sec, 30 sec, 1 min, 10 min, 30 min, and 1 hour).
5	Alarm	Set alarm output.
6	Group Rec.	Select the camera to record simultaneously.
7	Noti.	Set email notices.
8	Preset	Set preset of PTZ camera.
9	Copy Alarm Setup	Copy alarm set value to other channels. For more information about set value copy, see section "4.5.2 Stream > Main Stream in Stream."



Placing your mouse on **Alarm, Group Rec, Noti., Preset** and clicking editing Icon() in right corner displays Event : Alarm screen.

Figure 4-46 Event > Alarm In > Setup > Event : Alarm

Table 4-47 Event > Alarm In > Setup > Event : Alarm Item and Description

No.	Name	Function
1	Alarm-out	Set the alarm. <ul style="list-style-type: none"> Relay: Select/clear the Relay output checkbox. Dwell Time: Selecting alarm duration (Keep, 5 sec, 10 sec, 20 sec, 30 sec, 1 min, 10 min, 30 min, and 1 hour)
2	Group Recording	Select/deselect whether to use Group Recording.
3		Simultaneous recording camera channel screen opens.
4	Panic	Select/deselect whether to use Panic
5	Monitor Popup	Select/deselect whether to use Monitor Popup
6		Channel selection screen opens.
7	Remote Notification	Select/deselect whether to use E-mail, Push(Mobile) or FTP.
8	Preset	Preset of PTZ camera is running. <ul style="list-style-type: none"> Use: Select/deselect whether to use preset. CH: Select channels. Preset: Set preset value.

Alarm In > Schedule

To schedule recording time when alarm occurs across device sensors

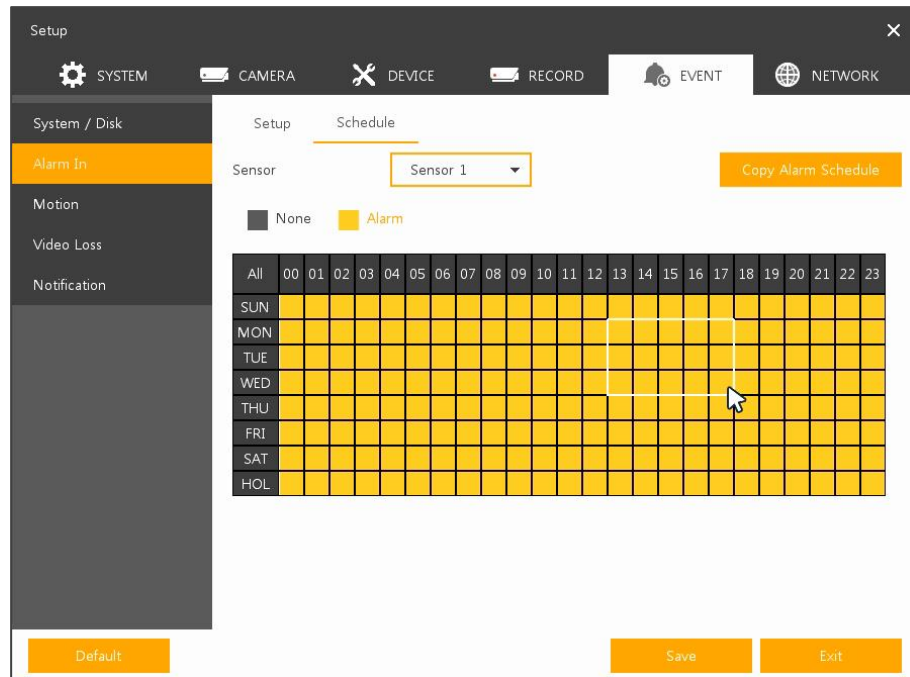

Figure 4-47 Event > Alarm In > Schedule

Table 4-48 Event > Alarm In > Schedule Item and Description

No.	Name	Function
1	Sensor	Select the sensor to set the schedule.
2	Schedule Type Selection	Select the types of schedules.
3	Schedule Table	Display the schedule users set.
4	Drag Field	Display the area dragged with a mouse.
5	Copy Alarm Schedule	Copy the schedule on alarm set to other sensors. For more information about set value copy, see section "4.5.2 Stream > Main Stream in Stream."

Note For more details about scheduling recording time when alarm occurs across sensors, see section "4.5.1 Schedule > Schedule."

4.6.3 Motion

To set and schedule motions across channels

Motion > Setup

To set motions across channels

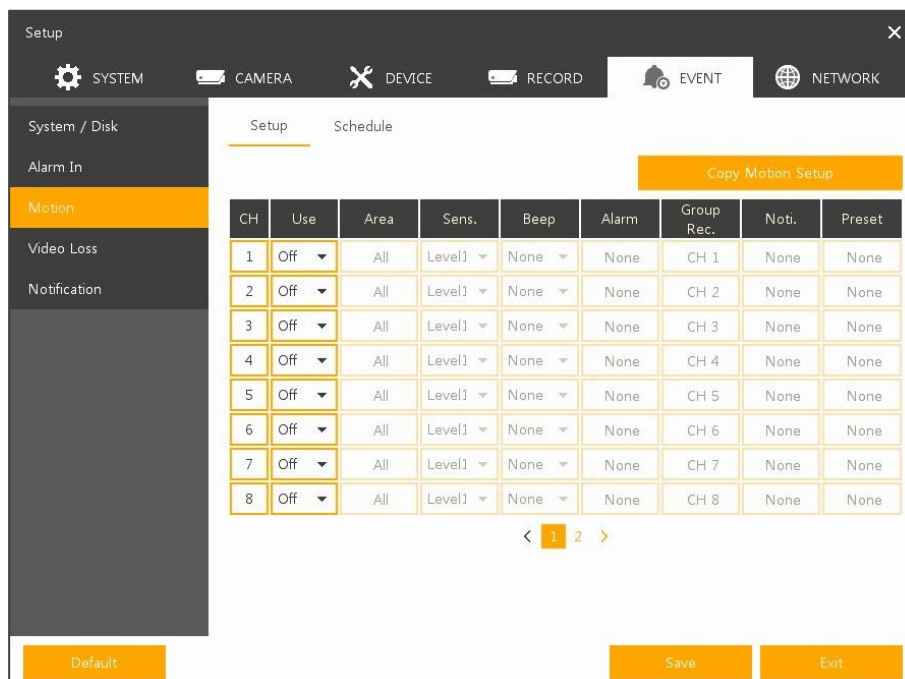

Figure 4-48 Event > Motion > Setup

Table 4-49 Event > Motion > Setup Item and Description

No.	Name	Function
1	CH	Display channels.
2	Use	<ul style="list-style-type: none"> Off: Do not use Motion events. Motion: set motion in NVR. VCA: use the VCA event input from the camera. See section "4.3.2 Advanced > Video Analytics Setup".
3	Area	It is activated when 'Motion' is selected in 'Use' menu. Sets the motion area and sensitivity.
4	Sens.	It displays the sensitivity set in the Motion Area (Level 1~10).
5	Beep	Select use time of buzzer (null, 5 sec, 10 sec, 20 sec, 30 sec, 1 min, 10 min, 30 min, and 1 hour).
6	Alarm	Set alarm output.
7	Group Rec.	Select the camera to record simultaneously.
8	Noti.	Set email notices.
9	Preset	Set preset of PTZ camera.
10	Copy Motion Setup	Copy motion set value to other channels. For more information about set value copy, see section "4.5.2 Stream > Main Stream in Stream."

Note Placing your mouse on **Alarm, Group Rec, Noti., Preset** and clicking editing icon(✎) in right corner displays Event : Alarm screen. For more information about **Event : Motion** screen, see section "4.6.2 Alarm In > Setup in Alarm In."

Caution If corridor mode are active at IP camera site you have to set resolution of 2nd Stream at 240x320 to trigger NVR Motion event

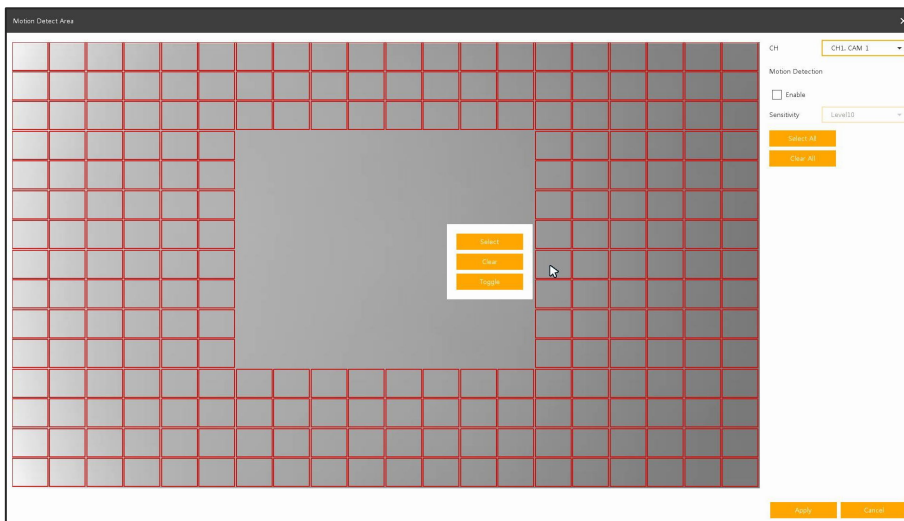

Figure 4-49 Event > Motion > Area Setup

Table 4-50 Event > Motion > Area Setup Item and Description

No.	Name	Function
1	CH	Display channels.
2	Motion Detection	Select to enable motion detect function.
3	Sensitivity	Select the sensitivity (Level1~10).
4	Select/Clear All	Select/Clear all motion detect area.
5	Select Clear Toggle	Click mouse left button to select the Select/ Clear/ Toggle the motion detect area.

Motion > Schedule

To schedule record time when the motion sensor detects across channels

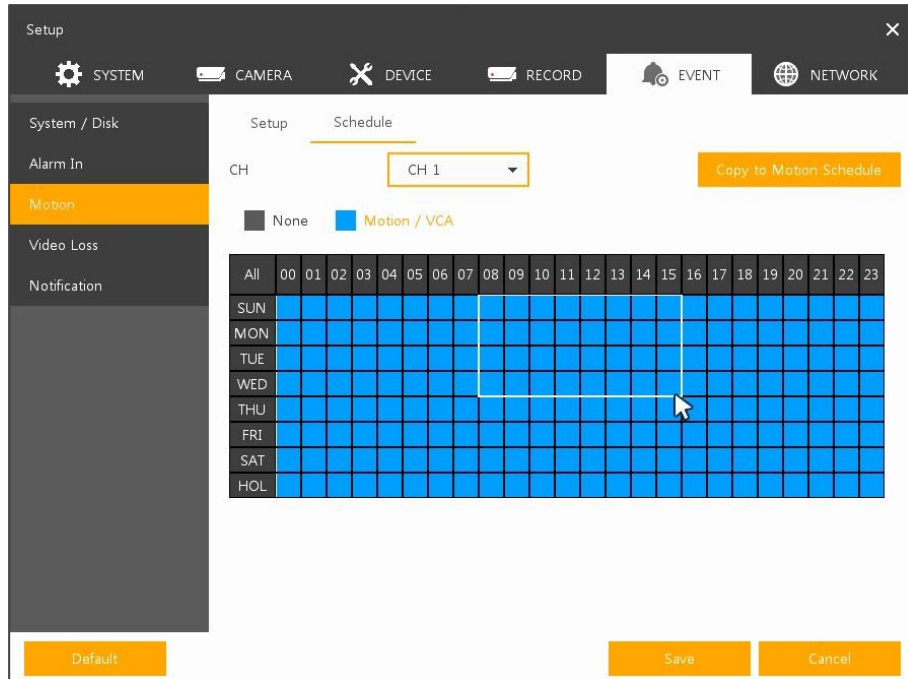

Figure 4-50 Event > Motion > Schedule

Table 4-51 Event > Motion > Schedule Item and Description

No.	Name	Function
1	CH	Select channels to set schedules.
2	Schedule Type Selection	Select the types of schedules.
3	Schedule Table	Display the schedule users set.
4	Drag Field	Display the area dragged with a mouse.
5	Copy to Motion Schedule	Copy the motion detection schedule to other channels. For more information about set value copy, see section "4.5.2 Stream > Main Stream in Stream."

Note For more information how to schedule record time when the motion sensor detects across channels, see section "4.5.1 Schedule > Schedule."

4.6.4 Video Loss > Setup

To set Video Loss across channels

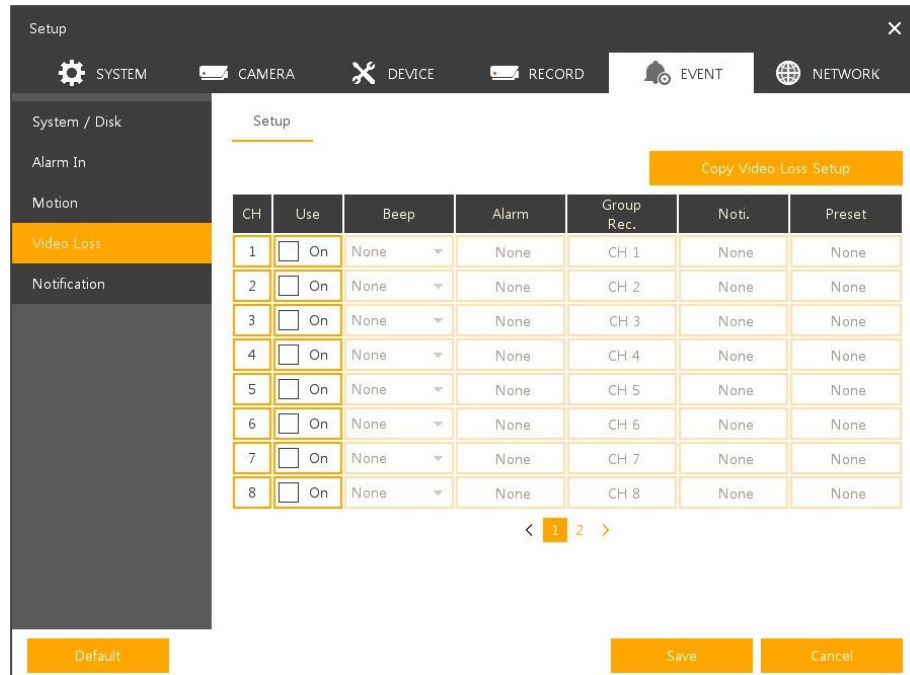

Figure 4-51 Event > Video Loss > Setup

Table 4-52 Event > Video Loss > Setup Item and Description

No.	Name	Function
1	CH	Display channels.
2	Use	Select/deselect whether to use Video Loss in the channel.
3	Beep	Select use time of buzzer sound (None, 5 sec, 10 sec, 20 sec, 30 sec, 1 min, 10 min, 30 min, and 1 hour).
4	Alarm	Set alarm output.
5	Group Rec.	Select the camera to record simultaneously.
6	Noti.	Set email notices.
7	Preset	Set preset of PTZ camera.
8	Copy Video Loss Setup	Copy the Video Loss set value to other channels. For more information about set value copy, see section "4.5.2 Stream > Main Stream in Stream."

Note Placing your mouse on **Alarm**, **Group Rec**, **Noti.**, **Preset** and clicking editing icon(✎) in right corner displays **Event : Video Loss** screen. For more information about **Event : Video Loss** screen, see section "4.6.2 Alarm In > Setup in Alarm In."

4.6.5 Notification

To set and schedule periodical alarms

Notification > Periodic

To set periodical alarms

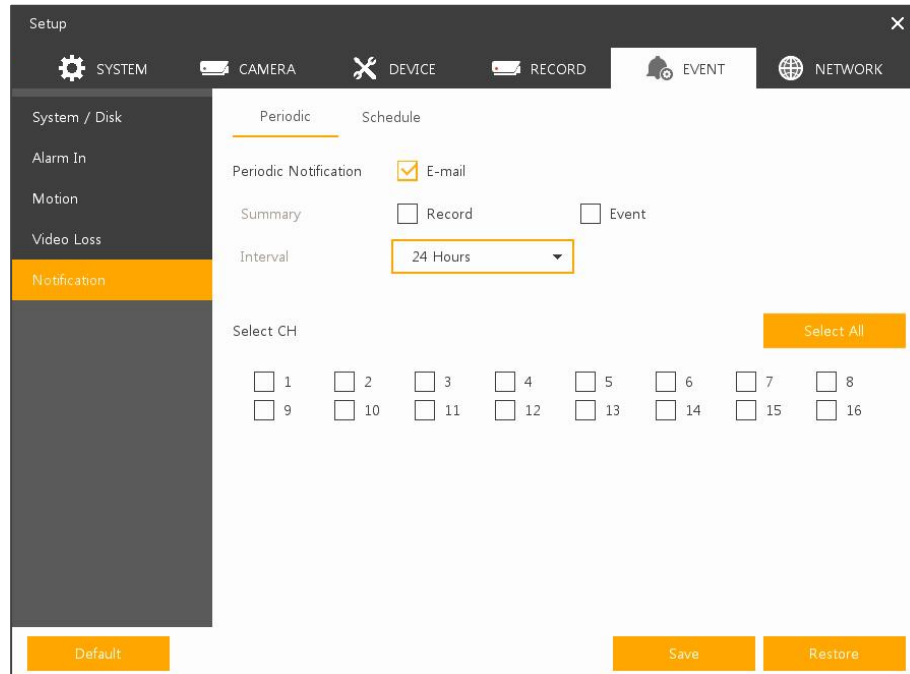

Figure 4-52 EVENT > Notification > Periodic

Table 4-53 EVENT > Notification > Periodic Item and Description

No.	Name	Function
1	Periodic Notification	Select/deselect whether to use periodical alarms
2	Summary	Send the save or event information. <ul style="list-style-type: none"> ▪ Record: sending the save information ▪ Event: sending the event information
3	Interval	Set the alarm interval (5 min, 10 min, 30 min, and 1 hour, 2-hour, 6-hour, 8-hour, 12-hour, and 24-hour).
4	Select CH	Select channels users want.
5	Select All /Unselect All	Select/deselect all channels

Notification > Schedule

To schedule periodical alarms

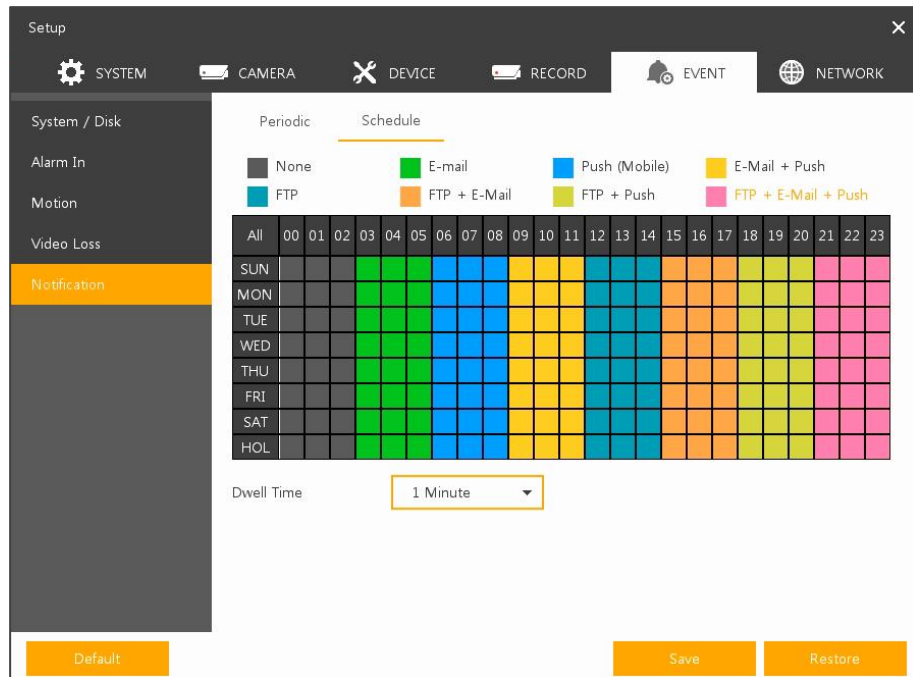

Figure 4-53 EVENT > Notification > Schedule

Table 4-54 EVENT > Notification > Schedule Item and Description

No.	Name	Function
1	Notification Type Selection	Select the types of notification. (None, E-mail, Push(Mobile), E-mail+Push, FTP, FTP+E-mail, FTP+Push, FTP+E-mail+Push)
2	Schedule Table	Display the schedule users set.
3	Drag Field	Display the area dragged with a mouse.
4	Dwell Time	Set Notification dwell time(1Min~1Hour).

Note For more information how to schedule record time when the alarm is detected, see section "4.5.1 Schedule > Schedule."

4.7 NETWORK

In **NETWORK**, users may set the network environment.

4.7.1 Basic

Basic > WAN Port

To set the network WAN port

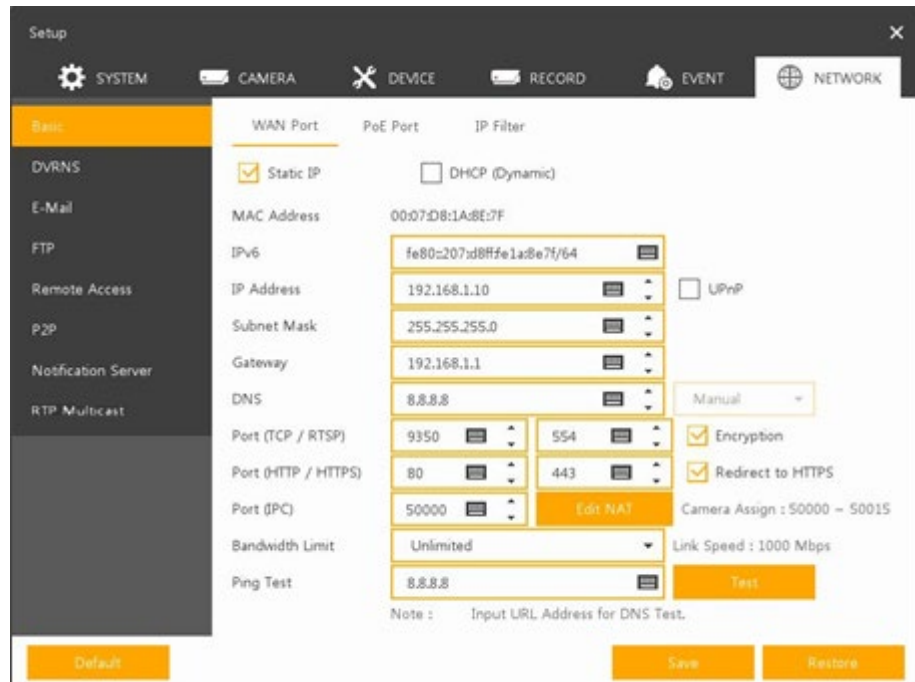

Figure 4-54 NETWORK > Basic > WAN Port

Table 4-55 NETWORK > Basic > WAN Port Item and Description

No.	Name	Function
1	Static IP	Check if you use static IP. For using static IP, enter IP address, Subnet Mask, and Gateway.
2	DHCP (Dynamic)	Select whether to use DHCP (Dynamic).
3	MAC Address	Display the MAC Address.
4	DNS	Select manual and enter DNS; otherwise choose automatic function.
5	Port (TCP/RTSP)	Enter TCP and RTSP port. Default is 9350.
6	Encryption	Select the Encryption box for video data by using TCP port. Select to encrypt for video data through TCP port.
7	Port(Http/Https)	Enter HTTP/HTTPS port. Default is 80.
8	Redirect to HTTPS	Select to allow HTTPS connect by request.
9	Port(IPC)	User can access camera directly using IPC port. Default is 5000.
10	Edit NAT	Select the protocol to be used for IP camera remote connection, either http or https, or block the connection.

No.	Name	Function
11	Bandwidth Limit	Select bandwidth to limit (Unlimited, 50Mbps, 10Mbps, 5Mbps, 2Mbps, 1Mbps, 500Kbps, 400Kbps, 300Kbps, 200Kbps, and 100Kbps).
12	Ping Test	Enter IP in Ping test and implement the text.

Fully encrypted connection in the WAN

- Provides encryption from recorder to all software components.

GDPR

DNS			
Port (TCP / RTSP)	9350	554	<input checked="" type="checkbox"/> Encryption
Port (HTTP / HTTPS)	80	443	<input checked="" type="checkbox"/> Redirect to HTTPS
Port (IPC)	50000	Edit NAT	Camera Assign : 50000 ~ 50015

Cameras on the PoE port can be isolated (NAT/IPC)

- Normally, the cameras can be reached on the PoE port in the network, but this can be completely isolated (according to Art. 32 GDPR).

GDPR

No.	NAT
1	HTTP
2	HTTP
3	HTTP
4	HTTP
5	HTTP
6	HTTP
7	HTTP
8	HTTP

< 1 2 >

Apply Cancel

Basic > PoE Port

To set the network PoE Port

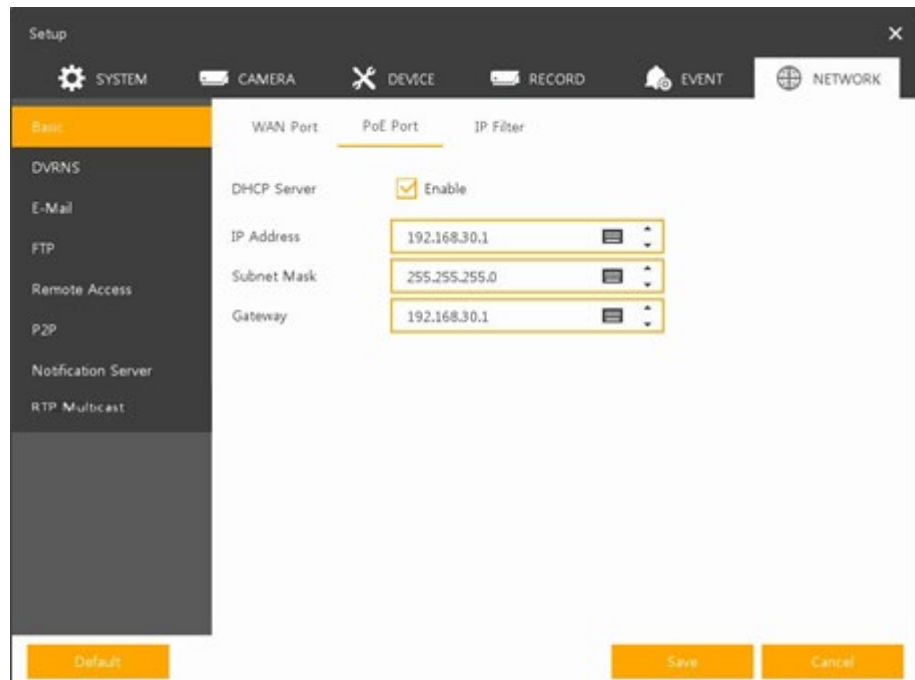

Figure 4-55 NETWORK > Basic > PoE Port

Table 4-56 NETWORK > Basic > PoE Port Item and Description

No.	Name	Function
1	DHCP Server	Select whether to enable DHCP server.
2	IP Address Subnet Mask Gateway	Enter the each information properly.

Basic > IP Filter

To set the network IP Filter

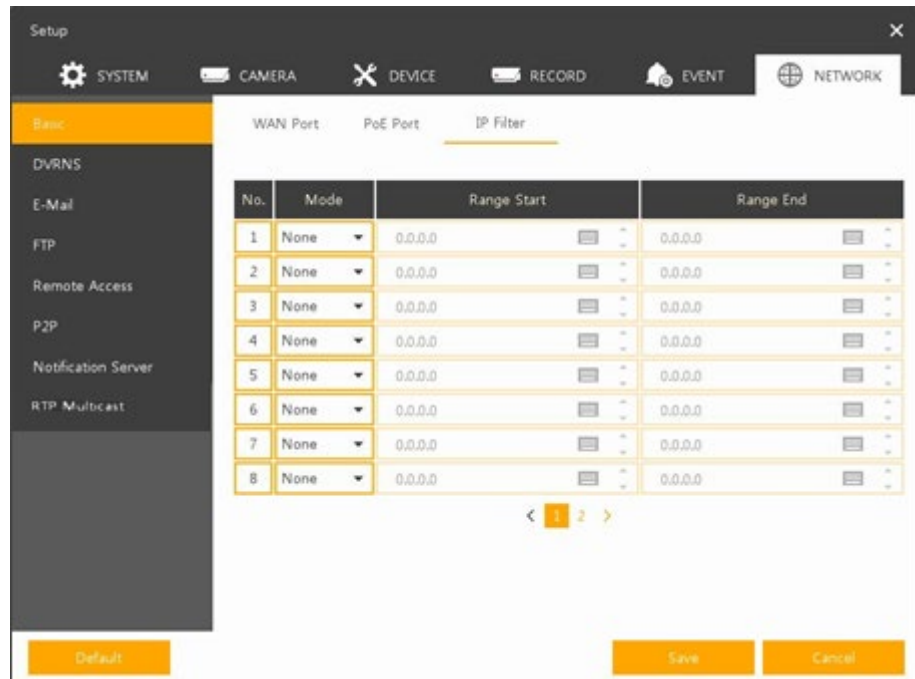

Figure 4-56 NETWORK > Basic > IP Filter

Table 4-57 NETWORK > Basic > IP Filter Item and Description

No.	Name	Function
1	Mode	Select None to disable. Select Access to access IP address range. Select Deny to restrict IP address range.
2	Range Start	Enter the Start IP address to Access or to Deny.
3	Range End	Enter the End IP address to Access or to Deny.

4.7.2 DVRNS

To set DVRNS

DVRNS

To register DVRNS account

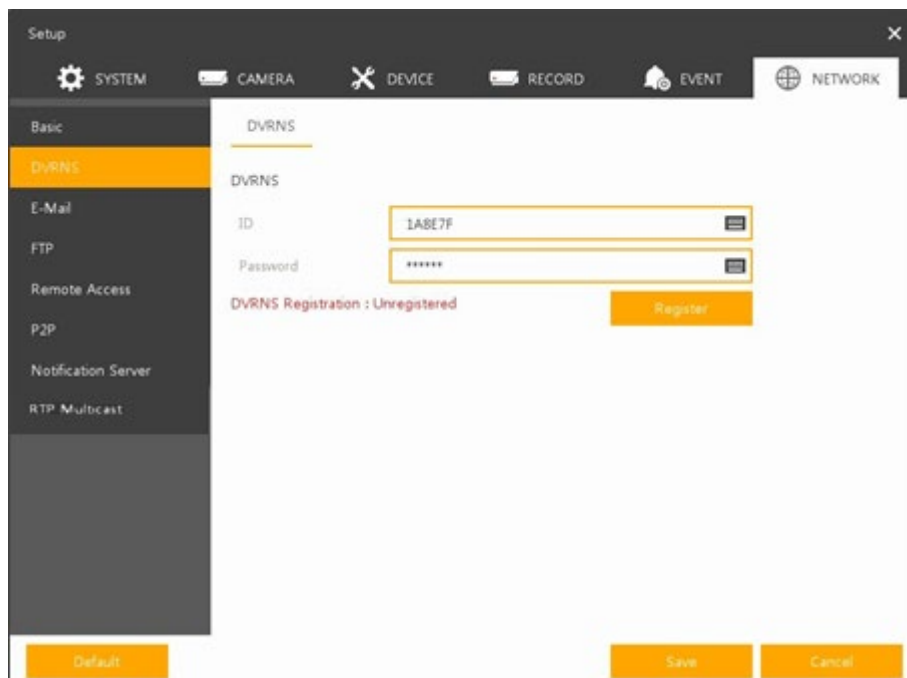

Figure 4-57 NETWORK > DVRNS > DVRNS

Table 4-58 NETWORK > DVRNS > DVRNS Item and Description

No.	Name	Function
1	DVRNS	Register DVRNS account <ul style="list-style-type: none">ID: Enter DVRNS ID (default: MAC address of the unit)Password: Enter DVRNS passwordRegister: Register DVRNS account

4.7.3 E-Mail

To set email server to send email on the occasion of event

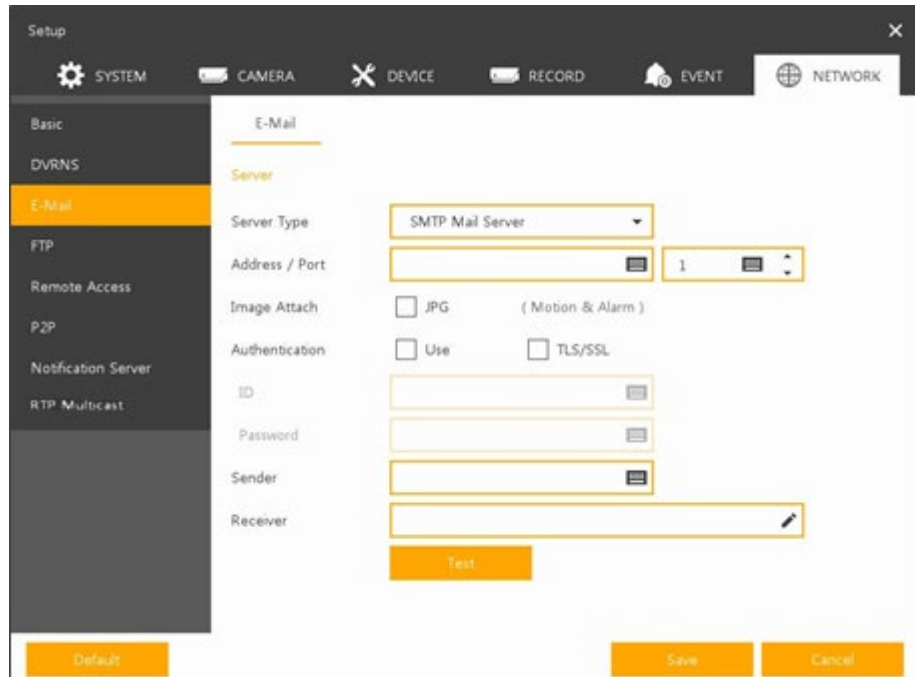

Figure 4-58 NETWORK > E-Mail > E-Mail

Table 4-59 NETWORK > E-Mail > E-Mail Item and Description

No.	Name	Function
1	Server Type	Select SMTP server. <ul style="list-style-type: none"> ▪ gmail.com ▪ hotmail.com ▪ aol.com ▪ naver.com ▪ daum.net
2	Address/Port	Enter server address and port number.
3	Image Attach	Select/deselect whether to attach JPG image.
4	Authentication	Select/deselect using authentication and password.
5	ID	Enter the email address.
6	Password	Enter the email password.
7	Sender	Write the sender.
8	Receiver	Write the receiver.
9	Test	Verify whether the email server is set normally.

4.7.4 FTP

Set up FTP server to send video to FTP server. The file format is AVI file.

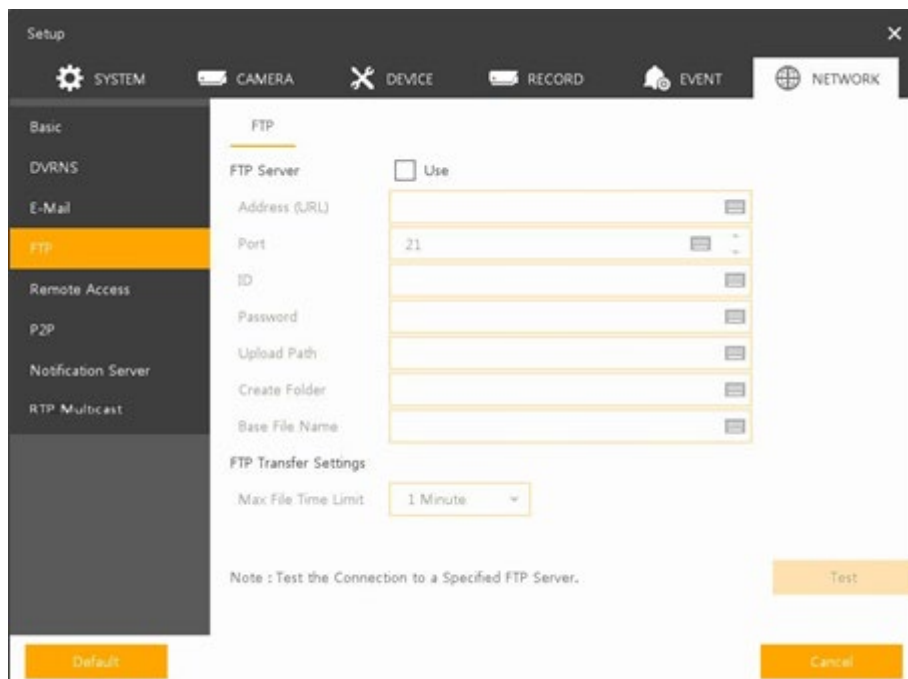

Figure 4-59 NETWORK > FTP > FTP

Table 4-60 NETWORK > FTP > FTP

No.	Name	Function
1	FTP Server	Select whether to use FTP.
2	Address(URL)/Port	Enter server address and port.
3	ID, Password	Enter ID & Password of server.
4	Upload Path	Enter upload directory.
5	Create Folder	Enter desired folder name.
6	Base File Name	Enter desired file name.
7	FTP Transfer Settings	Select max file time (1, 5, 10, 15minutes).
8	Test	Verify whether the FTP server is set normally.

4.7.5 Remote Access

Register the recorder to monitor and control remotely.

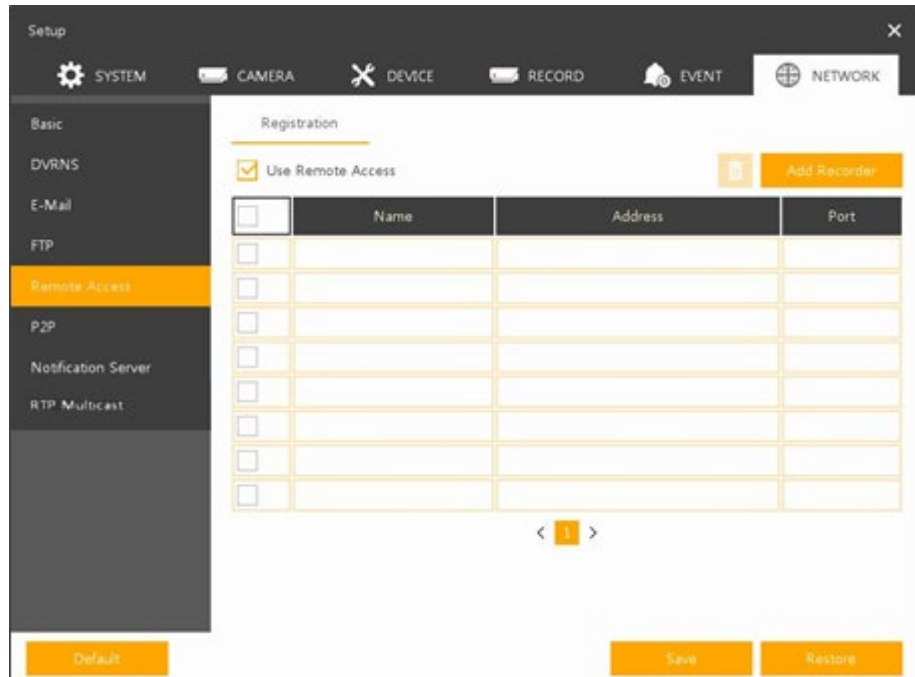



Figure 4-60 NETWORK > Remote Access > Registration

Table 4-61 NETWORK > Remote Access > Registration

No.	Name	Function
1	Use Remote Access	Select whether to use Remote Access. Registered devices can be selected in the Remote Access of a Quick menu.
2	Remote Access device list	Shows registered devices.
3		Delete the selected device.
4	Add Recorder	Register the recorder to monitor and control.

Clicking **Add Recorder** opens Add Recorder.

Figure 4-61 NETWORK > Remote Access > Registration > Add Recorder

Table 4-62 NETWORK > Remote Access > Registration > Add Recorder

No.	Name	Function
1	Device Type	Search all Remote Access-enabled devices in Auto Detect mode.
2	Device List	Show Remote Access-enabled device list. Click  button to search for a new device.
3	Name	Enter the device name. It is entered automatically when selected in the device list.
4	Address	Enter the device address. It is entered automatically when selected in the device list.
5	Port	Enter the TCP port. It is entered automatically when selected in the device list.
6	ID	Enter the ID of the device to be registered.
7	Password	Enter the password of the device to be registered.
8	Check	Click the Check button to check if you can connect.

4.7.6 P2P

User can connect recorder from mobile app using QR code scan.

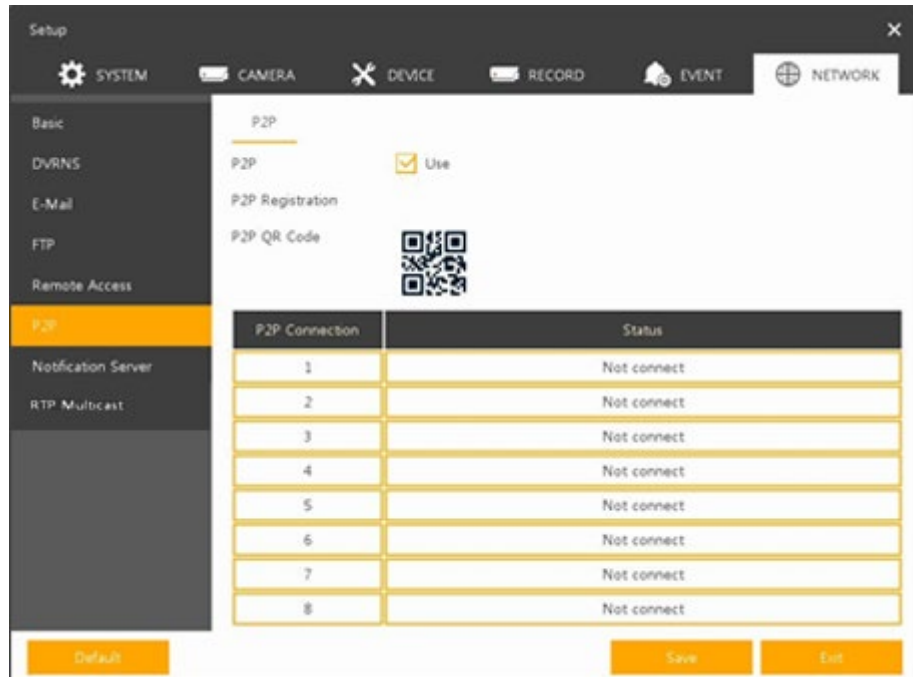

Figure 4-62 NETWORK > P2P > P2P

Table 4-63 NETWORK > P2P > P2P

No.	Name	Function
1	P2P Registration	Check up registration status.
2	P2P QR Code	Scan QR code using mobile app to connect recorder.
3	P2P Connection	Display connection stausts.

4.7.7 Server

Notification Server > Notification Server

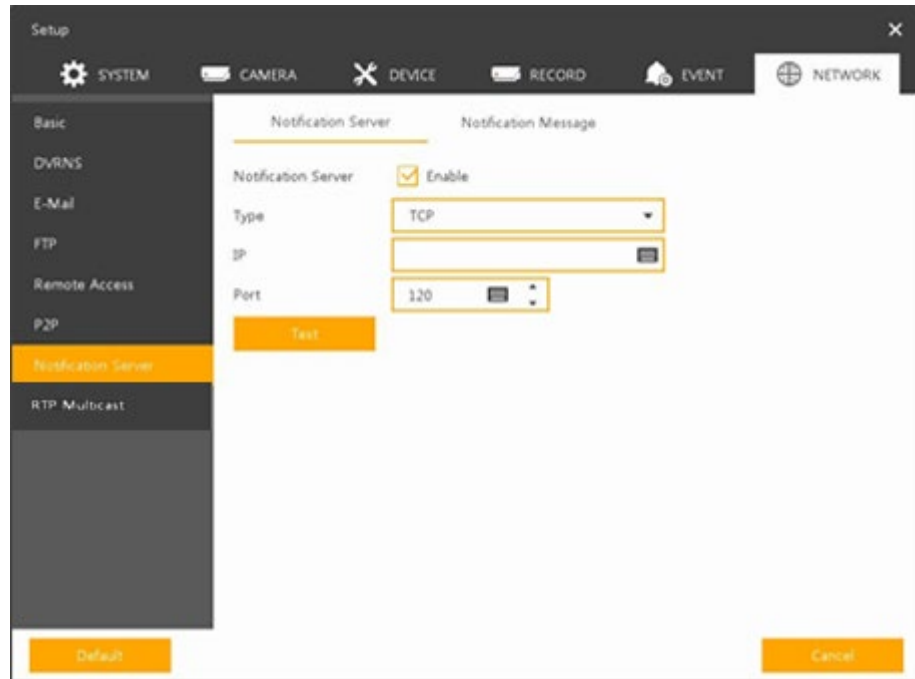

Figure 4-63 NETWORK > Notification Server > Notification Server

Table 4-64 NETWORK > Notification Server > Notification Server

No.	Name	Function
1	Notification Server	Select/deselect to use Notification server.
2	Type	Select TCP or UDP Protocol.
3	IP	Enter the server IP address or host name.
4	Port	Enter the server port.
5	Test	Send a test message to the server to check the connection status. Click Save button when the transmission is successful. TCP can check the results in the recorder, but UDP should be checked in the notification server.

Notification Server > Notification Message

Set up the message to be sent to the notification server when event occurs.

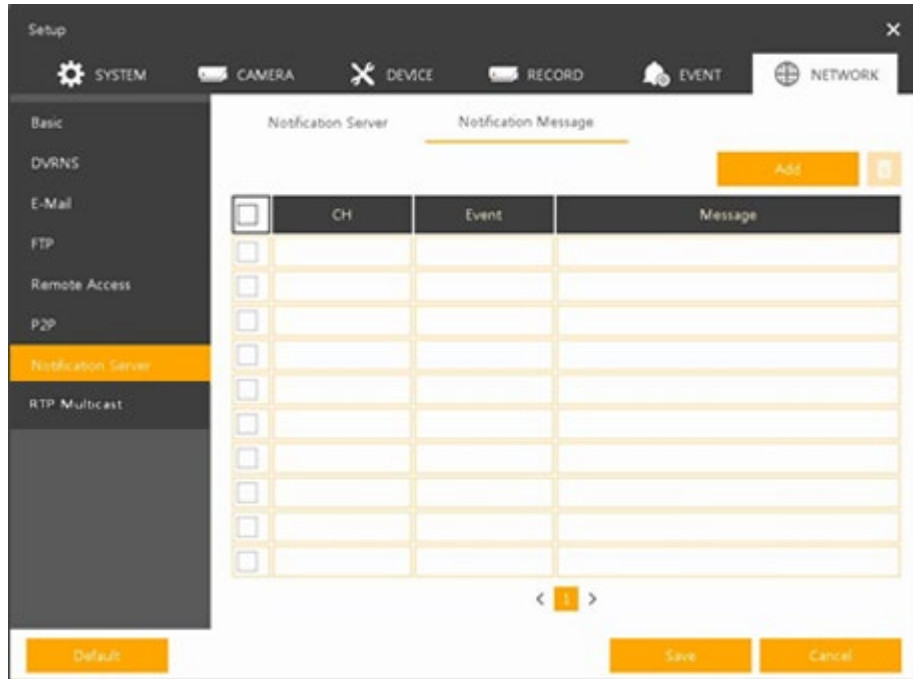



Figure 4-64 NETWORK > Notification Server > Notification Message

Table 4-65 NETWORK > Notification Server > Notification Message

No.	Name	Function
1	Add	Notification message edit window pop-up.
2		Deleted registered notification message.
3	CH	Camera channel.
4	Event	Display event type as Motion, Alarm, Video Loss.
5	Message	Display notification message.

Clicking **Add** opens **Add Message**

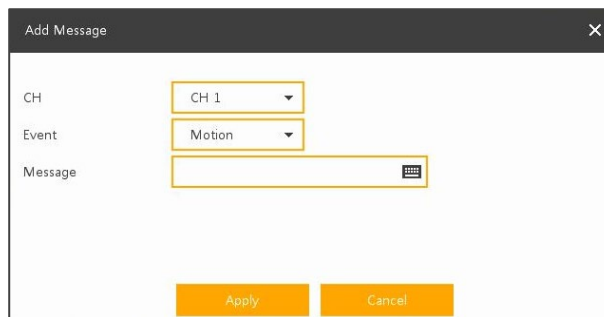

Figure 4-65 NETWORK > Notification Server > Notification Message > Add Message

Table 4-66 NETWORK > Notification Server > Notification Message > Add Message

No.	Name	Function
1	CH	Select the channel to add a message.

No.	Name	Function
2	Event	Select the event type (Motion, Alarm In, Video Loss).
3	Message	Create a message to send.

4.7.8 RTP Multicast

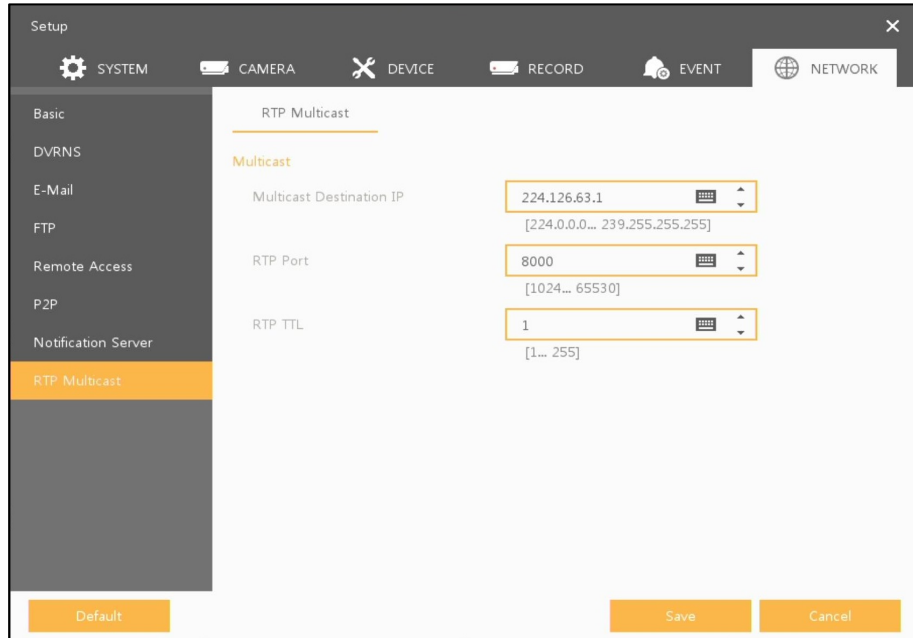

Figure 4-66 NETWORK > RTP Multicast

Table 4-67 NETWORK > RTP Multicast

No.	Name	Function
1	Multicast Destination IP	Enter the multicast destination IP.
2	RTP Port	Enter the RTP Port.
3	RTP TTL	Enter the RTP TTL. Time that packets are set to exist within the network before they are discarded by the router.

5. Search/Playback

This chapter describes Live Launcher search and play menu in the below screen bar.



Figure 5-1 Live Launcher Search, Play menu

Table 5-1 Item and Description of Live Launcher Search, Play menu

No.	Item	Description
1		Search recording data. (time, event, thumbnail, smart search, text and VCA).
2		Playback recorded data.

5.1 Search

This function searches recorded data as Time, Event, Thumbnail, Smart Search, Text and VCA.

Search > Time

Recording data is searched by date and time.

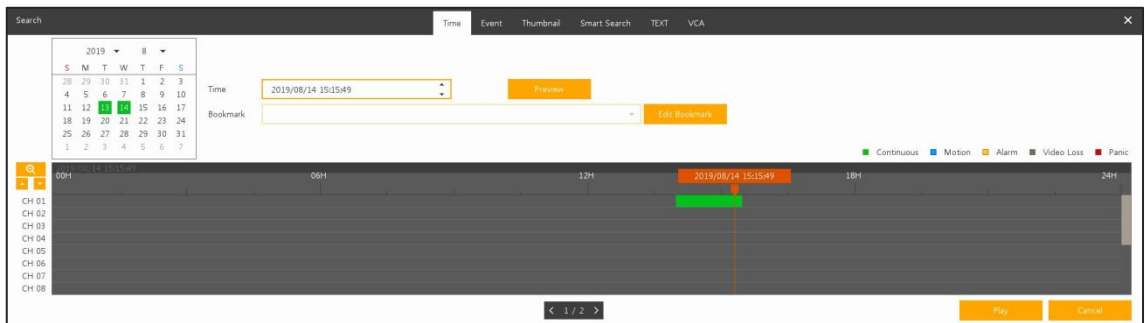

Figure 5-2 Search: Time

Table 5-2 Search: Time Item and Description

No.	Item	Description
1	Calendar	Selecting the date to search.
2	Time	Setting time to search.
3	Bookmark	Selecting a bookmark to search.
4	Timeline	Display timelines across channels.
5	Preview	Previewing video clips searched.
6	Play	Playing video clips. For more information about Live bar, see section "5.2 Playback".
7	Cancel	Ending search screen.

Search > Event

Recording data is searched by event type.

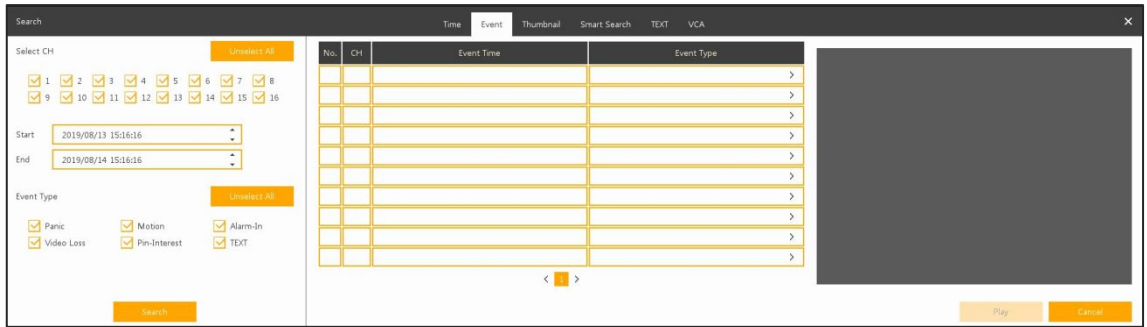

Figure 5-3 Search: Event

Table 5-3 Search: Event Item and Description

No.	Item	Description
1	Select CH	Select channels to search.
2	Select All /Unselect All	Select/deselect all channels.
3	Start	Setting starting time to search.
4	End	Setting ending time to search.
5	Event Type	Selecting the types of event (Panic, Motion, Alarm-In, Video Loss, Pin-Interest and TEXT).
6	Search	Searching the event.
7	Event List	Displaying event list searched.
8	Thumbnail Field	Displaying thumbnail images of selected event.
9	Play	Playing video clips selected. For more information about Live bar, see section "5.2 Playback".
10	Cancel	Ending search screen.

Search > Thumbnail

Recording data is searched and played back as a thumbnail image at intervals of time.



Figure 5-4 Search: Thumbnail

Table 5-4 Search: Thumbnail Item and Description

No.	Item	Description
1	Calendar	Selecting dates to search.
2	CH	Selecting channels to search.

No.	Item	Description
3	Time	Selecting time to search
4	Interval	Setting time interval for searching images
5	Time Overlap	Selecting the overlapping section to play if there is a duplicate of the same time by changing the time.
6	Time Lapse/Pause	Playing or stopping videos searched
7	Cancel	Ending search screen

Search > Smart Search

Recording data is searched by detecting change of specific area.

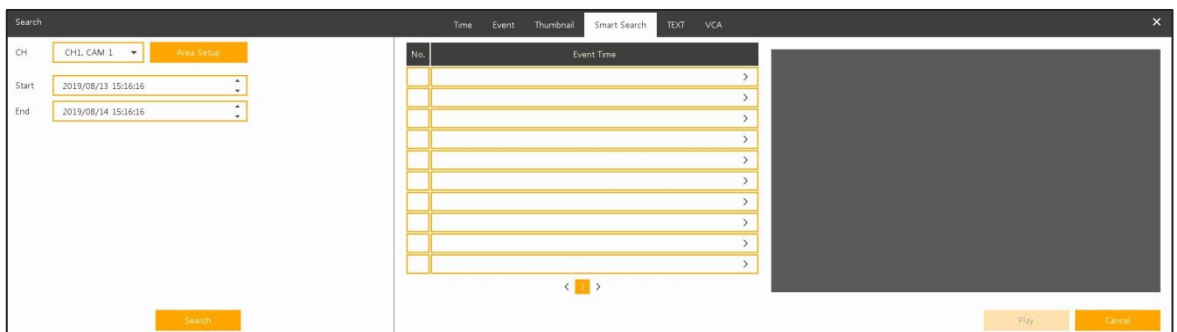

Figure 5-5 Search: Smart Search

Table 5-5 Search: Smart Search Item and Description

No.	Item	Description
1	CH	Selecting channels to search.
2	Area Setup	Select area to search motion event.
3	Start	Setting starting time to search.
4	End	Setting ending time to search.
5	Search	When motion is detected in the set area, it is displayed in the list.
6	Event List	Displaying event list searched.
7	Thumbnail Field	Displaying thumbnail images of selected event.
8	Play	Playing video clips selected. For more information about playback launcher, see section "5.2 Playback."

Search > TEXT

Recording data is searched by keyword.

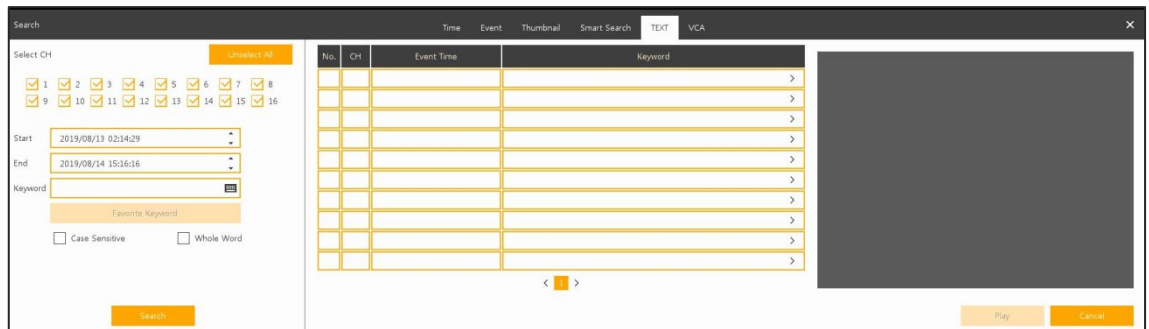

Figure 5-6 Search: TEXT

Table 5-6 Search: TEXT Item and Description

No.	Item	Description
1	Select CH	Select channels to search.
2	Select All /Unselect All	Select/deselect all channels.
3	Start	Setting starting time to search.
4	End	Setting ending time to search.
5	Keyword	Entering keyword to search.
6	Case Sensitive	Searching items in case-sensitive.
7	Whole Word	Searching items that include all words.
8	Search	Searching the event.
9	Event List	Displaying event list searched.
10	Thumbnail Field	Displaying thumbnail images of selected event.
11	Play	Playing video clips selected. For more information about Live bar, see section "5.2 Playback".
12	Cancel	Ending search screen.

Search > VCA

Recording data is searched by VCA event type.

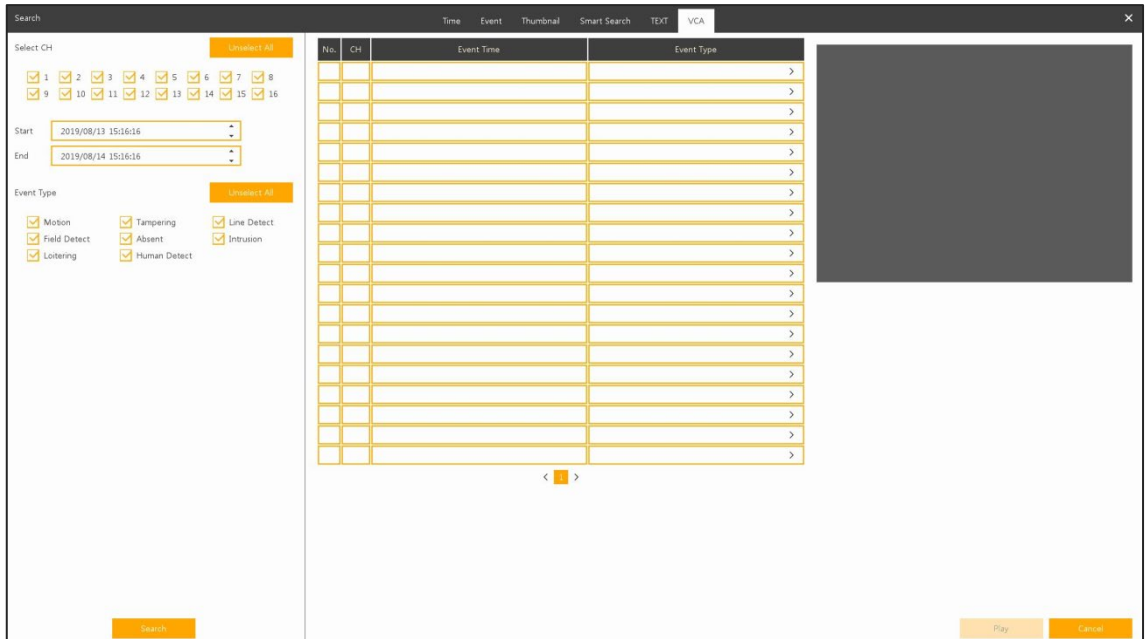

Figure 5-7 Search: VCA

Table 5-7 Search: VCA Item and Description

No.	Item	Description
1	Select CH	Selecting channels to search
2	Start, End	Set start time and end time.
3	Event Type	Selecting VCA event type.
4	Search	Search VCA event.
5	Event List	Displaying event list searched
6	Thumbnail Field	Displaying thumbnail images of selected event
7	Play	Playback selected event.
8	Cancel	Ending search screen

5.2 Playback

To play recorded data



Figure 5-8 Playback Launcher

Table 5-8 Playback Launcher Item and Description

No.	Item	Description
1		Display present play status.
2	Date and Time	Display date and time of playing videos.
3		Go to first section of the video.
4		Play fast backward(2~64x).
5		Decrease speed under playback mode (1/2~1/8x), Backward step under pause mode
6		Play backward, forward and pause the videos.
7		Play forward step.
8		Play fast forward(2~64x).
9		Go to last section of the video.
10		Moving to previous/next partition screens
11		Selecting the partition mode to mark in the screen
12		Audio output on-off(toggle).
13		Searching the recorded data (time, event, thumbnail, smart search, text, and VCA). For more information about search, see section "5.1 Search."
14		Closing playing videos and moving to live screen.
15		Opening or closing the record time-line.
16		Activating/deactivating automatic hidden function of Launcher menu.

Clicking opens **Record Time-Line**.

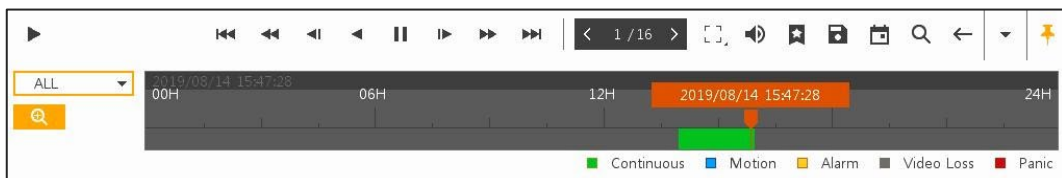







Figure 5-9 Playback Launcher > Record Time-Line

Table 5-9 Playback Launcher > Record Time-Line Item and Description

No.	Name	Function
1	Time lines	Shows the time recording status. Select the desired time with the mouse.
2		Add bookmarks at the selected time in the timeline.
3		Run a manual backup. For more information about manual backup, see section "3.2.1 Backup".
4		Open the calendar pop-up window and select a date from the calendar.
5		Show time bar by single channel, quad channels or all channels.
6		Show time line by 1hour or 24hours (toggle).

Click mouse right button to open **Quick menu** in the playback mode.

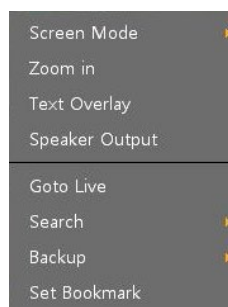

Figure 5-10 Playback Quick menu

Table 5-10 Playback Quick menu

No.	Item	Description
1	Screen Mode	Select the partition mode of live screen (Full, 2X2, 3X3, and 4x4).
2	Zoom in	Magnify selected live screen (2x, 4x, and 8x). This menu is shown full screen mode only.
3	Text Overlay	POS text overlay on the screen. This menu is shown when enable Text menu.
4	Speaker Mute	Audio out off.
5	Goto Live	Stop playback and return to live mode.
6	Search	Open Search window.
7	Backup	Open manual backup menu.
8	Set Bookmark	Save the bookmark.

6. Webviewer

This chapter describes webviewer for monitoring videos through a PC in remote mode.

Table 6-1 System Requirement for Webviewer

Item	Recommended	Minimum
OS	Microsoft® Windows® 10 x86(64bit) (Home Premium, Professional, Ultimate) Microsoft® Windows® 8(pro, Enterprise)	Microsoft® Windows® XP Home SP3
CPU	Intel Core™ i5-2550 3.30GHz or higher	Intel Core™ 2 Duo E7200 2.53GHz or higher
RAM	2GB or higher	1.5GB or higher
VGA	ATI Radeon™ HD 3650 or NVIDIA GeForce 8400GS or higher(1280x1024, 32bpp or Higher), Multi Monitor	ATI Radeon™ HD 2400 or NVIDIA GeForce FX5500 or higher(1024x768, 24bpp or higher)
HDD	Over 6GB	Over 1GB
LAN	Gigabit Ethernet	10/100 Mbps Ethernet

How to monitor with webviewer

- 1 Enter IP address of a recorder in Internet browser.

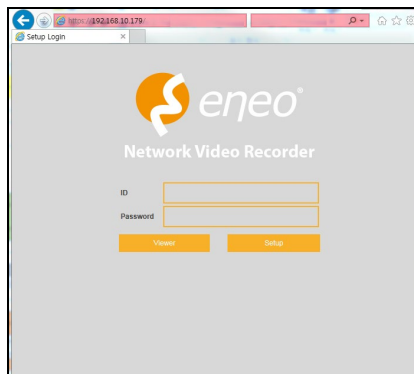

- 2 Enter ID and Password, and then click the button.
 - Viewer: playing NVR Live images
 - Setup: setting menu in similar ways with NVR connected monitor.

For using Viewer, users need to download Java. The way to download is shown as follows:

In case of selecting Viewer(Internet Explorer)

- 1 Click **Viewer**.

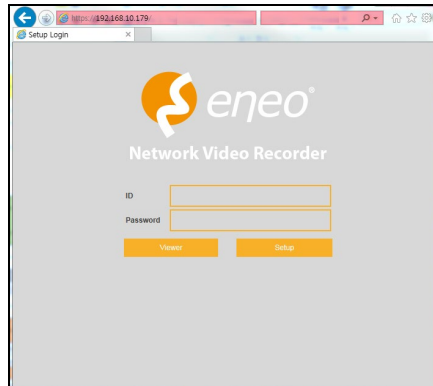

- 2 When Java download screen opens, download and install JAVA.

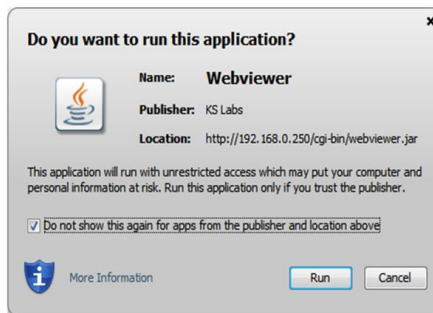

- 3 Live images may be monitored.



In case of selecting Viewer(Chrome)

- 1 After click **Viewer**, .jnlp file can be downloaded.
Click **Keep** button.

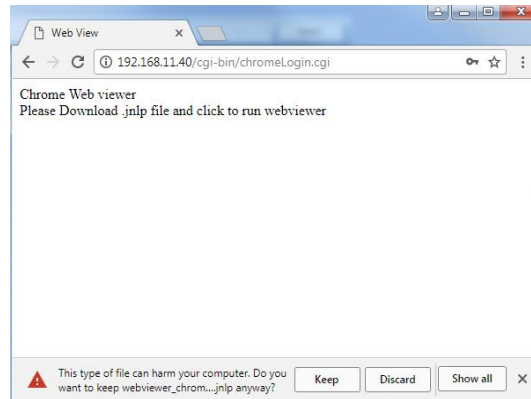

- 2 Click **webviewer_chrome.jnlp**.

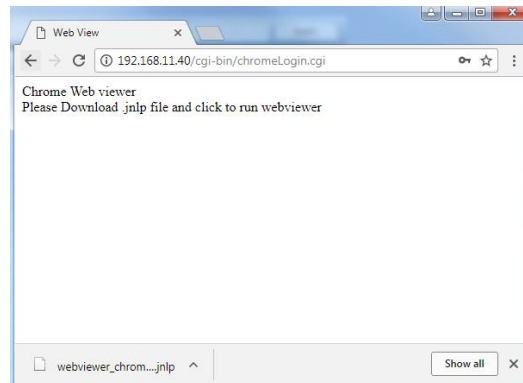

- 3 When Java download screen opens, download and install JAVA.

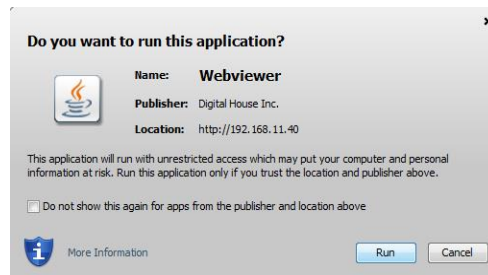

- 4 Live images may be monitored.

In case of selecting Setup

Users can set the menu in similar ways with NVR connected monitor.

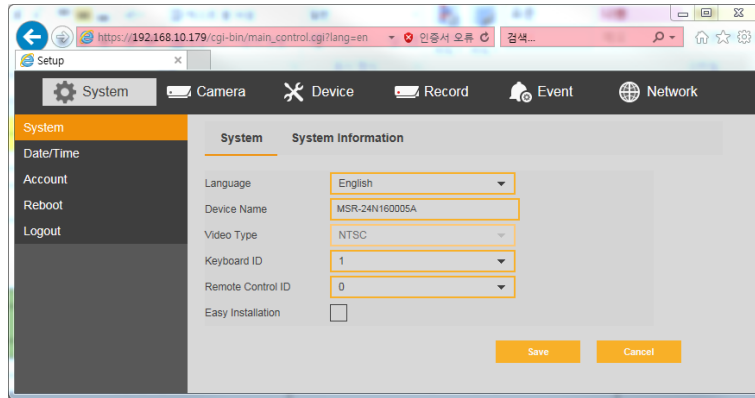

Figure 6-1 Setup screen

7. Appendix

7.1 Installing System Keyboard

To setup the keyboard controllers, the user needs to setup the network, passwords and perform special tasks such as Uploading and Downloading programmed data from the dome cameras. To enter the Keyboard menu, press and hold CTRL and press MENU expressed as CTRL + MENU in the manual. You will see the following menu.

Keyboard Setup- for USB

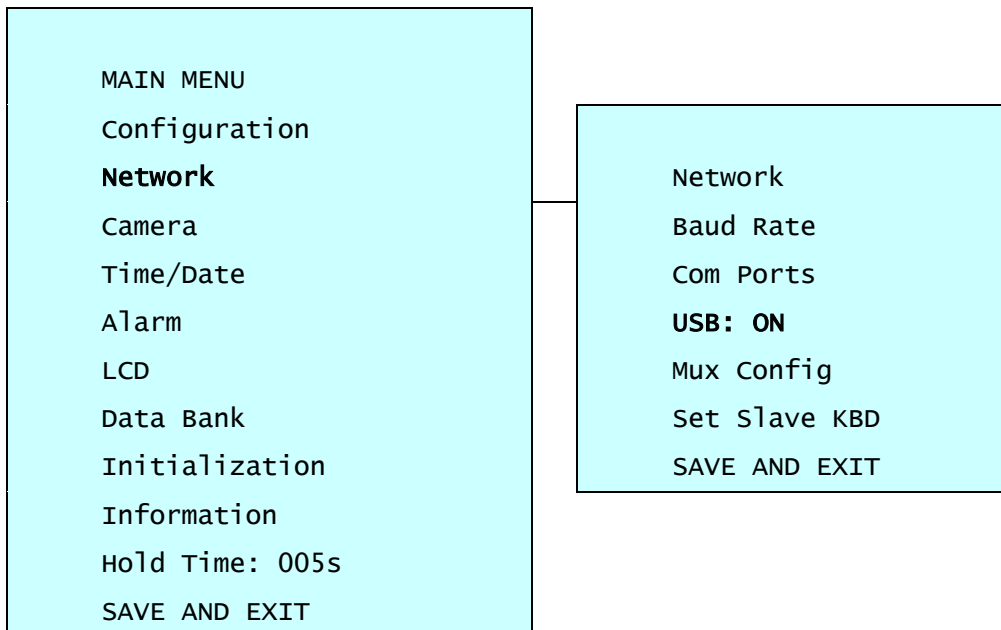
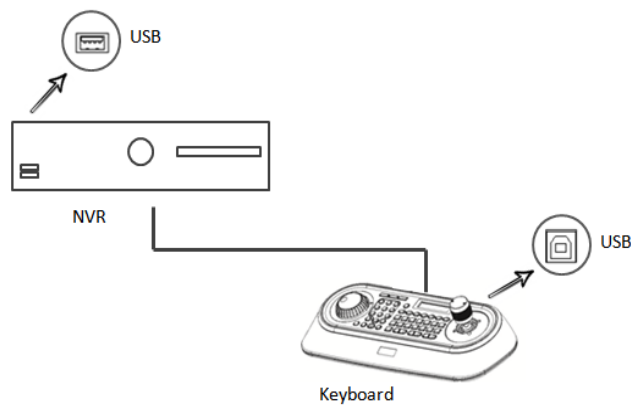

Set USB On in the keyboard menu.

Menu	Status	Configuration
USB	ON	Client Keyboard : Only USB Port(The other ports and slave keyboards are not supported)
	OFF	General Keyboard : Dome1/Dome2/RS232(The USB port is not supported)

Note

If Keyboard Controller power is disconnected and reconnected, you must also disconnect and reconnect the USB either from the Keyboard Controller or DVR/NVR side

Keyboard Setup- for RS485

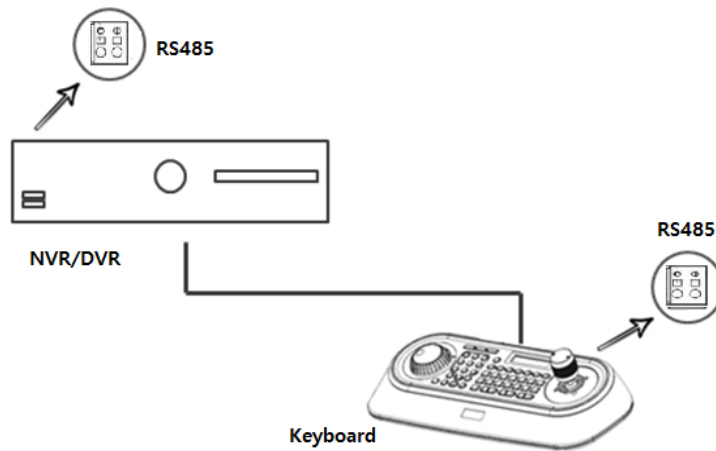

SET USB Off and Dome1: DVR5 in keyboard menu.

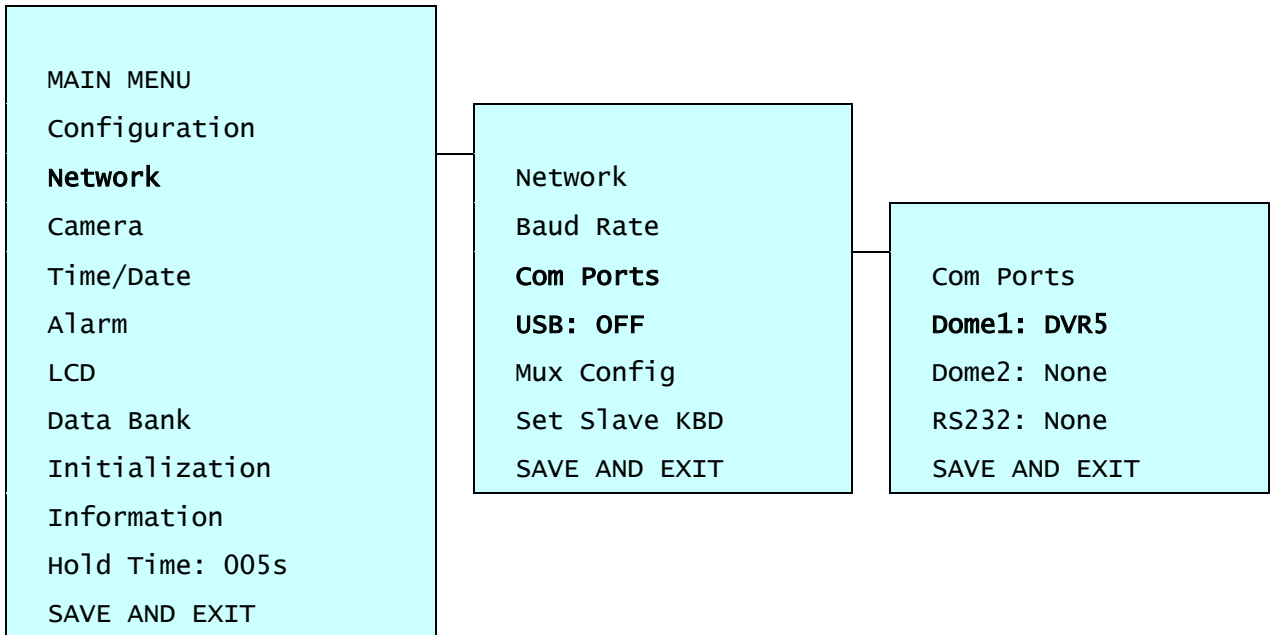

Recorder Setup

Set serial port of recorder.

Device > Serial Device

USB (to Serial)					
Name	Baudrate	Parity	Data Bit	Stop Bit	Type
USB	9600	None	8	1	Keyboard

RS-485					
Name	Baudrate	Parity	Data Bit	Stop Bit	Type
RS-485	9600	None	8	1	PTZ









In case of USB Connection









Name	Baudrate	Parity	Data	Stop bit	Type
USB	9600	None	8	1	Keyboard

In case of RS-485 Connection





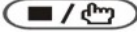



Name	Baudrate	Parity	Data	Stop bit	Type
RS-485	9600	None	8	1	Keyboard





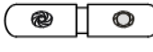
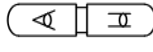

KBD Controller Keys in Live mode

Function	Key Label	Descriptions
Menu		Enter the DVR/NVR MENU screen. Pressing the button also closes the MENU screen. Using the Joystick, you can navigate menu and select by turning the Joystick clockwise. This will also function as Enter.
Display Mode		Change the display mode to different split screen.
PTZ		Control PTZ camera(s) connected channel(show  icon). In the PTZ control mode, PTZ icon change to  . Please  to open PTZ quick menu. Press PTZ button again to exit PTZ mode.
Enter		Select a highlighted item or completes an entry that you have made. Using the Joystick and turning it clockwise will also function as Enter.
Full Screen and Input Number	No.+ 	Displays selected channel in full screen. However, when selecting a channel to display in full screen, no channels must be highlighted (yellow border) in the multi-channel mode.
Digital Zoom		From Live display, select the desired channel and press Zoom button to activate the Zoom Mode. Twist joystick to zoom in and out control.





		Press again to exit zoom mode.
Digital Zoom Control		Digital zoom in/out control.
Freeze		From Live Display, click the FRE button to activate the Freeze Mode.
Auto Sequence Mode		When in the Live Mode, press the SEQ button will display another full live channel sequentially.
Alarm		Will turn off the alarm and beep.
Record		Toggle will start and stop the panic recording operation.
Search		Open search menu. Press again, menu move to Time -> Event -> Thumbnail -> Smart Search -> Text -> VCA. Click cancel in the recorder menu or press  to exit search menu.
Play		Go to Playback mode. During playback, pause the video.
Joystick		<ul style="list-style-type: none"> - The use of the Joystick will allow you select channels, view in different modes (single or multiple), Zoom in/out, Select/Enter or navigate through menu. - Turn the Joystick counter clockwise for single view mode.

KBD Controller Keys in PTZ mode

Function	Key Label	Descriptions
PRESET, TOUR, PTRN, SCAN Action	No. +    	PRST, TOUR, PTRN, SCAN action
PRESET Setting	No. +  	Preset save.
Zoom		Zoom in/out control. Turn the Joystick clockwise or counter clockwise for zoom in/out control.
Iris		Iris Open/Close control, Smart focus(specific camera). Open camera OSD menu(specific camera)
Focus		Focus Near/Far control.
Configuration		Enters PTZ programming menu.
Control		CTRL + Joystick : In a programming mode (Preset, Pattern, Scan, Privacy...) the

		joystick operates as if in the normal control mode. While pressing and holding down the CTRL key, all movements of the joystick will start recording when in the pattern programming menu
Cancel		Cancels current inputs. Exits from currently running functions or menu, error status, etc.
Enter		Completes entering data for the password or title
PTZ		Enter or exit PTZ mode.
Menu	MACRO 	Open PTZ quick menu.
Enter	SET 	Enter button under quick menu or pop-up menu.
Channel Change	No. + 	Channel change.
Joystick		PTZ control or menu navigation control.

KBD Controller Keys in Playback mode

Function	Key Label	Descriptions
Play Back Control		Play/Pause recorded data
Play Back (PB) Stop		Pause/Play, Fast Forward, Fast Rewind, Forward One Frame, Go Back One Frame
Play Back (PB) Stop		Stop Playback and return to Live mode
Jog/Shuttle		Fast Forward, Fast Rewind, Forward One Frame, Go Back One Frame

7.2 Product Specification

Channel	4ch	8ch	16ch
VIDEO			
Video Input	4 IP	8 IP	16 IP
Video Input resolution	Up to 8MP	Up to 8MP	Up to 8MP
Compression	H.264, H.265	H.264, H.265	H.264, H.265
Display Output	1 VGA, 1 HDMI	1 VGA, 1 HDMI	1 VGA, 1 HDMI
Display Resolution	3840x2160, 1920x1080, 1280x720, 1024x768	3840x2160, 1920x1080, 1280x720, 1024x768	3840x2160, 1920x1080, 1280x720, 1024x768
Display Speed	100/120fps(PAL/NTSC)	200/240fps(PAL/NTSC)	400/480fps(PAL/NTSC)
Display Mode	1/4 Split, Sequence	1/4/9 Split, Sequence	1/4/9/16 Split, Sequence
RECORDING			
Recording Speed	100/120fps@8MP(PAL/NTSC)	200/240fps@8MP(PAL/NTSC)	400/480fps@8MP(PAL/NTSC)
Max. Recording Throughput	32Mbps	64Mbps	128Mbps
Recording Mode	Continuous(C), Motion(M), Alarm(A), C+M, C+A, M+A, C+M+A, Panic	Continuous(C), Motion(M), Alarm(A), C+M, C+A, M+A, C+M+A, Panic	Continuous(C), Motion(M), Alarm(A), C+M, C+A, M+A, C+M+A, Panic
Pre Alarm	1 ~ 5sec	1 ~ 5sec	1 ~ 5sec
Post Alarm	5sec ~ 1hour	5sec ~ 1hour	5sec ~ 1hour
PLAYBACK			
Simultaneous Playback	1/4 Split	1/4/9 Split	1/4/9/16 Split
Playback Mode	Backward, Forward 2x~64x	Backward, Forward 2x~64x	Backward, Forward 2x~64x
Search Mode	Time, Event, Thumbnail, Smart Search, Text, VCA	Time, Event, Thumbnail, Smart Search, Text, VCA	Time, Event, Thumbnail, Smart Search, Text, VCA
STORAGE			
Internal HDD	2 SATA Interfaces	2 SATA Interfaces	2 SATA Interfaces
External Storage	iSCSI	iSCSI	iSCSI
Backup	USB	USB	USB
Backup File Format	AVI, H4V	AVI, H4V	AVI, H4V
FUNCTION			
Text In	POS/ATM(VSSI-Pro, ASCII, Network)	POS/ATM(VSSI-Pro, ASCII, Network)	POS/ATM(VSSI-Pro, ASCII, Network)
User Interface	Mouse, USB/RS485 Keyboard	Mouse, USB/RS485 Keyboard	Mouse, USB/RS485 Keyboard

NETWORK				
Ethernet	WAN	1 RJ45 10/100/1000 Base-T	1 RJ45 10/100/1000 Base-T	1 RJ45 10/100/1000 Base-T
	PoE	4 RJ45 10/100 Base-T	8 RJ45 10/100 Base-T	16 RJ45 10/100 Base-T
	PoE Power	38W(IEEE802.3at compliance)	73W(IEEE802.3at compliance)	130W(IEEE802.3at compliance)
Max. Output Throughput	Unlimited (Guarantee 72Mbps, Support Bandwidth Control)	Unlimited (Guarantee 144Mbps, Support Bandwidth Control)	Unlimited (Guarantee 288Mbps, Support Bandwidth Control)	
Remote Monitoring	CMS, Mobile, Web, Dashboard	CMS, Mobile, Web, Dashboard	CMS, Mobile, Web, Dashboard	
EXTERNAL IN/OUT				
Audio In	1 RCA, 4 IP Camera	1 RCA, 8 IP Camera	1 RCA, 16 IP Camera	
Audio Out	1 RCA, 1 HDMI	1 RCA, 1 HDMI	1 RCA, 1 HDMI	
Alarm In	4 Input(Terminal block)	8 Input (Terminal block)	16 Input (Terminal block)	
Alarm Out	1 Output(Terminal block)	1 Output (Terminal block)	1 Output (Terminal block)	
Serial Port	1 RS485(Terminal block)	1 RS485(Terminal block)	1 RS485(Terminal block)	
USB	2 USB2.0, 1 USB3.0	2 USB2.0, 1 USB3.0	2 USB2.0, 1 USB3.0	
ETC				
Operating Humidity	0 ~ 90% RH (Non-condensing)	0 ~ 90% RH (Non-condensing)	0 ~ 90% RH (Non-condensing)	
Operating Temperature	0°C ~ +40°C	0°C ~ +40°C	0°C ~ +40°C	
Power Supply	DC 48V, 1.2A	DC 48V, 2.0A	AC 110~220V	
Power Consumption	18.5W (Exclude 2HDD, Except PoE)	21.12W (Exclude 2HDD, Except PoE)	25W (Exclude 2HDD, Except PoE)	
Dimension(WxHxD)	375x44.9x318.2mm	375x44.9x318.2mm	375x44.9x318.2mm	
Net Weight	2.3Kg(Exclude HDD)	2.3Kg(Exclude HDD)	3.1Kg(Exclude HDD)	

※ Specifications are subject to change without notice.



eneo® is a registered trademark of
VIDEOR E. Hartig GmbH
Exclusive distribution through special-
ised trade channels only.

VIDEOR E. Hartig GmbH
Carl-Zeiss-Straße 8
63322 Rödermark/Germany
Tel. +49 (0) 6074 / 888-0
Fax +49 (0) 6074 / 888-100
www.videor.com
www.eneo-security.com

Technical changes reserved

© Copyright by VIDEOR E. Hartig
GmbH Version 04/2020