



User Manual

Multisignal HD Video Recorder,  
HD-TVI, AHD, 960H

MPR-32R080200A

MPR-32R160200A





## WARNING

RISK OF ELECTRIC SHOCK  
DO NOT OPEN



**WARNING:** TO REDUCE THE RISK OF ELECTRIC SHOCK,  
DO NOT REMOVE COVER (OR BACK).  
NO USER-SERVICEABLE PARTS INSIDE.  
REFER SERVICING TO QUALIFIED  
SERVICE PERSONNEL.



The lightning flash with arrowhead symbol, within an equilateral triangle, is intended to alert the user to the presence of uninsulated "dangerous voltage" within the product's enclosure that may be of sufficient magnitude to constitute a risk of electric shock.



The exclamation point within an equilateral triangle is intended to alert the user to the presence of important operating and maintenance (servicing) instructions in the literature accompanying the appliance.

Symbol	Publication	Description
	IEC60417, No.5032	Alternating current

### COMPLIANCE NOTICE OF FCC:

THIS EQUIPMENT HAS BEEN TESTED AND FOUND TO COMPLY WITH THE LIMITS FOR A CLASS A DIGITAL DEVICE, PURSUANT TO PART 15 OF THE FCC RULES. THESE LIMITS ARE DESIGNED TO PROVIDE REASONABLE PROTECTION AGAINST HARMFUL INTERFERENCE WHEN THE EQUIPMENT IS OPERATED IN A COMMERCIAL ENVIRONMENT. THIS EQUIPMENT GENERATES, USES, AND CAN RADIATE RADIO FREQUENCY ENERGY AND IF NOT INSTALLED AND USED IN ACCORDANCE WITH THE INSTRUCTION MANUAL, MAY CAUSE HARMFUL INTERFERENCE TO RADIO COMMUNICATIONS. OPERATION OF THIS EQUIPMENT IN A RESIDENTIAL AREA IS LIKELY TO CAUSE HARMFUL INTERFERENCE, IN WHICH CASE USERS WILL BE REQUIRED TO CORRECT THE INTERFERENCE AT THEIR OWN EXPENSE.

**WARNING:** CHANGES OR MODIFICATIONS NOT EXPRESSLY APPROVED BY THE PARTY RESPONSIBLE FOR COMPLIANCE COULD VOID THE USER'S AUTHORITY TO OPERATE THE EQUIPMENT.

THIS CLASS OF DIGITAL APPARATUS MEETS ALL REQUIREMENTS OF THE CANADIAN INTERFERENCE-CAUSING EQUIPMENT REGULATIONS.

The information in this manual is believed to be accurate as of the date of publication even though explanation about some functions may not be incorporated. We are not responsible for any problems resulting from the use thereof. The information contained herein is subject to change without notice. Revisions or new editions to this publication may be issued to incorporate such changes.

The software included in this product contains some Open Sources. You may obtain the complete corresponding source code from us. See the Open Source Guide on the software CD (*OpenSourceGuide\OpenSourceGuide.pdf*) or as a printed document included along with the User's Manual.

## Important Safeguards

<p><b>1. Read Instructions</b> All the safety and operating instructions should be read before the appliance is operated.</p> <p><b>2. Retain Instructions</b> The safety and operating instructions should be retained for future reference.</p> <p><b>3. Cleaning</b> Unplug this equipment from the wall outlet before cleaning it. Do not use liquid aerosol cleaners. Use a damp soft cloth for cleaning.</p> <p><b>4. Attachments</b> Never add any attachments and/or equipment without the approval of the manufacturer as such additions may result in the risk of fire, electric shock or other personal injury.</p> <p><b>5. Water and/or Moisture</b> Do not use this equipment near water or in contact with water.</p> <p><b>6. Placement and Accessories</b> Do not place this equipment on an unstable cart, stand or table. The equipment may fall, causing serious injury to a child or adult, and serious damage to the equipment. This equipment and cart combination should be moved with care. Quick stops, excessive force, and uneven surfaces may cause the equipment and cart combination to overturn. Do not place this equipment on a closed space. Sufficient amount of ventilation air is necessary to avoid increase of ambient temperature which can cause improper operation or the risk of fire.</p> <p><b>7. Power Sources</b> This equipment should be operated only from the type of power source indicated on the marking label. If you are not sure of the type of power, please consult your equipment dealer or local power company. You may want to install a UPS (Uninterruptible Power Supply) system for safe operation in order to prevent damage caused by an unexpected power stoppage. Any questions concerning UPS, consult your UPS retailer. This equipment should be remain readily operable.</p> <p><b>8. Power Cords</b> Operator or installer must remove power and TNT connections before handling the equipment.</p> <p><b>9. Lightning</b> For added protection for this equipment during a lightning storm, or when it is left unattended and unused for long periods of time, unplug it from the wall outlet and disconnect the antenna or cable system. This will prevent damage to the equipment due to lightning and power-line surges.</p>	<p><b>10. Overloading</b> Do not overload wall outlets and extension cords as this can result in the risk of fire or electric shock.</p> <p><b>11. Objects and Liquids</b> Never push objects of any kind through openings of this equipment as they may touch dangerous voltage points or short out parts that could result in a fire or electric shock. Never spill liquid of any kind on the equipment.</p> <p><b>12. Servicing</b> Do not attempt to service this equipment yourself. Refer all servicing to qualified service personnel.</p> <p><b>13. Damage requiring Service</b> Unplug this equipment from the wall outlet and refer servicing to qualified service personnel under the following conditions: A. When the power-supply cord or the plug has been damaged. B. If liquid is spilled, or objects have fallen into the equipment. C. If the equipment has been exposed to rain or water. D. If the equipment does not operate normally by following the operating instructions, adjust only those controls that are covered by the operating instructions as an improper adjustment of other controls may result in damage and will often require extensive work by a qualified technician to restore the equipment to its normal operation. E. If the equipment has been dropped, or the cabinet damaged. F. When the equipment exhibits a distinct change in performance – this indicates a need for service.</p> <p><b>14. Replacement Parts</b> When replacement parts are required, be sure the service technician has used replacement parts specified by the manufacturer or that have the same characteristics as the original part. Unauthorized substitutions may result in fire, electric shock or other hazards.</p> <p><b>15. Safety Check</b> Upon completion of any service or repairs to this equipment, ask the service technician to perform safety checks to determine that the equipment is in proper operating condition.</p> <p><b>16. Field Installation</b> This installation should be made by a qualified service person and should conform to all local codes.</p> <p><b>17. Correct Batteries</b> Warning: Risk of explosion if battery is replaced by an incorrect type. Replace only with the same or equivalent type. Dispose of used batteries according to the instructions. The battery shall not be exposed to excessive heat such as sunshine, fire or the like.</p> <p><b>18. Tmra</b> A manufacturer's maximum recommended ambient temperature (Tmra) for the equipment must be specified so that the customer and installer may determine a suitable maximum operating environment for the equipment.</p>
---	---



## WEEE (Waste Electrical & Electronic Equipment)

### Correct Disposal of This Product

*(Applicable in the European Union and other European countries with separate collection systems)*



This marking shown on the product or its literature, indicates that it should not be disposed with other household wastes at the end of its working life. To prevent possible harm to the environment or human health from uncontrolled waste disposal, please separate this from other types of wastes and recycle it responsibly to promote the sustainable reuse of material resources.

Household users should contact either the retailer where they purchased this product, or their local government office, for details of where and how they can take this item for environmentally safe recycling.

Business users should contact their supplier and check the terms and conditions of the purchase contract. This product should not be mixed with other commercial wastes for disposal.

## Table of Contents

Chapter 1 — Introduction.....	1
Feature.....	1
Technical Overview.....	1
Chapter 2 — Installation.....	3
Package Contents.....	3
Required Installation Tools.....	3
Video Input.....	3
Alarm Input/Output.....	4
RS485 Port.....	4
RS232 Port.....	4
eSATA Port.....	5
Factory Reset Switch.....	5
Video Out.....	5
Network Port.....	5
Audio In/Out.....	6
Power Cord Connector.....	6
Chapter 3 — Configuration.....	7
Front Panel Controls.....	7
Camera Buttons (1 to 16).....	8
Enter Button.....	8
Arrow Buttons.....	8
Menu Button.....	8
ZOOM Button.....	8
PTZ Button.....	9
Panic Button.....	9
LED.....	9
Display Button.....	9
Monitor Button.....	9
Bookmark Button.....	9
Freeze Button.....	9
Alarm Button.....	9
Playback Buttons.....	10
Jog Dial, Shuttle Ring.....	10
USB Port.....	10
ID Button on Remote Control.....	10
Sequence Button on Remote Control.....	11
Clip Copy Button on Remote Control.....	11
Turning on the Power.....	11
Initial Unit Setup.....	11
Setup Screen.....	12
System Setup.....	13
General.....	13
Date/Time.....	21
User.....	22
Storage.....	25
System Event.....	26
Recording Setup.....	28
General.....	28
Schedule.....	29

Pre-Event.....	31
Event Setup.....	32
Motion.....	32
Tripzone.....	33
Alarm-In.....	35
Video Loss.....	36
Video Blind.....	37
Text-In.....	38
Camera Setup.....	40
General.....	40
PTZ.....	41
Device Setup.....	42
Audio.....	42
Alarm-Out.....	43
Remote Control.....	44
Network Setup.....	45
General.....	45
LAN.....	46
FEN.....	48
RTSP.....	49
WebGuard.....	50
VNC.....	50
NetFS.....	51
Notification Setup.....	53
Callback.....	53
Mail.....	53
SNS.....	55
FTP.....	56
Schedule.....	57
Display Setup.....	58
OSD.....	58
Main Monitor.....	59
Spot Monitor.....	60
Chapter 4 — Operation.....	61
Turning on the Power.....	61
Live Monitoring.....	61
Live Monitoring Menu.....	62
Active Cameo Mode.....	64
Zoom Mode.....	64
PTZ Mode.....	64
Event Monitoring.....	66
Covert Camera.....	66
Spot Monitoring.....	66
Status Monitoring.....	67
Recording Video.....	68
Panic Recording.....	69
Recording Audio.....	69
Playing Recorded Video.....	69
Searching Video.....	70
Search Menu.....	71
Event Log Search.....	73
Record Table Search.....	75
Motion Search.....	76

Text-In Search .....	78
Bookmarks .....	79
Clip-Copy .....	80
Print .....	82
Disk Mirroring .....	82
Appendix .....	85
USB Hard Disk Drive Preparation .....	85
Text-In Search Examples .....	85
Search Example I .....	85
Search Example II .....	86
WebGuard .....	87
Web Monitoring Mode .....	88
Web Search Mode .....	89
Time Overlap .....	91
Error Code Notices .....	91
System Log Notices .....	92
Map of Screens .....	93
Troubleshooting .....	94
Specifications .....	94

## List of Illustrations

Figure 1: Typical DVR installation.....	2
Figure 2: DVR rear panel.....	3
Figure 3: DVR front panel.....	7
Figure 4: Infrared remote control.....	8
Figure 5: Login screen.....	11
Figure 6: Logout screen.....	11
Figure 7: Setup screen.....	12
Figure 8: System – General setup screen.....	13
Figure 9: System – Date/Time setup screen.....	21
Figure 10: System – User setup screen.....	22
Figure 11: System – Storage setup screen.....	25
Figure 12: System – System Event setup screen.....	26
Figure 13: Record – General setup screen.....	28
Figure 14: Record – Schedule setup screen.....	29
Figure 15: Schedule – Settings (Advanced Mode) setup screen.....	30
Figure 16: Record – Pre-Event setup screen.....	31
Figure 17: Event – Motion setup screen.....	32
Figure 18: Event – Tripzone setup screen.....	33
Figure 19: Event – Alarm-In setup screen.....	35
Figure 20: Event – Video Loss setup screen.....	36
Figure 21: Event – Video Blind setup screen.....	37
Figure 22: Event – Text-In setup screen.....	38
Figure 23: Camera – General setup screen.....	40
Figure 24: Camera – PTZ setup screen.....	41
Figure 25: Device – Audio setup screen.....	42
Figure 26: Device – Alarm-Out setup screen.....	43
Figure 27: Device – Remote Control setup screen.....	44

Figure 28: Network – General setup screen..... 45

Figure 29: Network – LAN setup screen..... 46

Figure 30: Network – FEN setup screen..... 48

Figure 31: Network – RTSP setup screen. .... 49

Figure 32: Network – WebGuard setup screen. .... 50

Figure 33: Network – VNC setup screen. .... 50

Figure 34: Network – NetFS. .... 52

Figure 35: Notification – Callback setup screen. .... 53

Figure 36: Notification – Mail setup screen..... 53

Figure 37: Notification – SNS setup screen..... 55

Figure 38: Notification – FTP setup screen. .... 56

Figure 39: Notification – Schedule setup screen. .... 57

Figure 40: Display – OSD setup screen. .... 58

Figure 41: Display – Main Monitor setup screen. .... 59

Figure 42: Display – Spot Monitor setup screen..... 60

Figure 43: Live Monitoring menu. .... 61

Figure 44: PTZ Select Camera menu. .... 65

Figure 45: PTZ Preset menu. .... 65

Figure 46: Event Status – Event Status screen. .... 67

Figure 47: Event Status – Storage screen..... 68

Figure 48: Select Playback Camera menu. .... 69

Figure 49: Search menu. .... 70

Figure 50: Event Log Search screen. .... 73

Figure 51: Record Table Search screen..... 75

Figure 52: Motion Search screen..... 76

Figure 53: Text-In Search screen. .... 78

Figure 54: Bookmarks screen..... 79

Figure 55: Clip-Copy screen. .... 80

Figure 56: Print screen. .... 82

Figure 57: System – Storage setup screen. .... 82



## Chapter 1 — Introduction

### Feature

Your color digital video recorder (DVR) provides recording capabilities for eight or 16 camera inputs. It provides exceptional picture quality in both live and playback modes, and offers the following features:

- Live Monitoring for Each Channel
- Compatible with Color (NTSC or PAL) and B&W (CCIR and EIA-170) Video Sources
- Auto Detection for HD-TVI Input
- Auto Detection for NTSC and PAL
- H.264 Codec
- Multiple Monitor Connectors: 1 HDMI, 1 VGA, 1 SPOT
- UTC for Camera Menu Control via Coax Cable
- Multiple Search Engines (Date/Time, Calendar, Record Table, Event)
- Real-time Recording (480 Images per Second with Very High (Full HD) Resolution)
- Continuous Recording in Disk Overwrite Mode
- Video Recording via eSATA Interface
- 2 (USB 2.0) port
- Continues Recording while Transmitting to Remote Site and during Playback
- User-friendly Graphical User Interface (GUI) Menu System
- Multiple Recording Modes (Time-lapse, Pre-event, Alarm, Motion and Panic)
- Two-way Audio Communication
- 4-Channel Audio Recording and 1-Channel Audio Playback
- Text Input for ATM and POS
- Alarm Connections Include: Input, Output
- Built-in Alarm Buzzer
- Live or Recorded Video Access via Ethernet
- Time Synchronization using industry standard protocol
- IR Remote Control
- Self-diagnostics with automatic notification including hard disk drive S.M.A.R.T. protocol

### Technical Overview

In addition to replacing both a time-lapse VCR and a multiplexer in a security installation, your DVR has many features that make it much more powerful and easier to use than even the most advanced VCR.

The DVR converts analog NTSC or PAL video to digital images and records them on a hard disk drive. Using a hard disk drive allows you to access recorded video almost instantaneously; there is no need to rewind tape. The technology also allows you to view recorded video while the DVR continues recording video.

Digitally recorded video has several advantages over analog video recorded on tape. There is no need to adjust tracking. You can freeze frames, fast forward, fast reverse, slow forward and slow reverse without image streaking or tearing. Digital video can be indexed by time or events, and you can instantly view video after selecting the time or event.

Your DVR can be set up for event or time-lapse recording. You can define times to record, and the schedule can change for different days of the week and user defined holidays.

The DVR can be set up to alert you when the hard disk drive is full, or it can be set to record over the oldest video once the disk is full.

Your DVR uses a proprietary encryption scheme making it nearly impossible to alter video.

You can view video and control your DVR remotely by connecting via Ethernet. There is an eSATA port that can be used to record (eSATA interface only) video to external hard disk drives, and there are two USB ports that can be used to upgrade the system or copy video clips to external hard disk and flash drives.

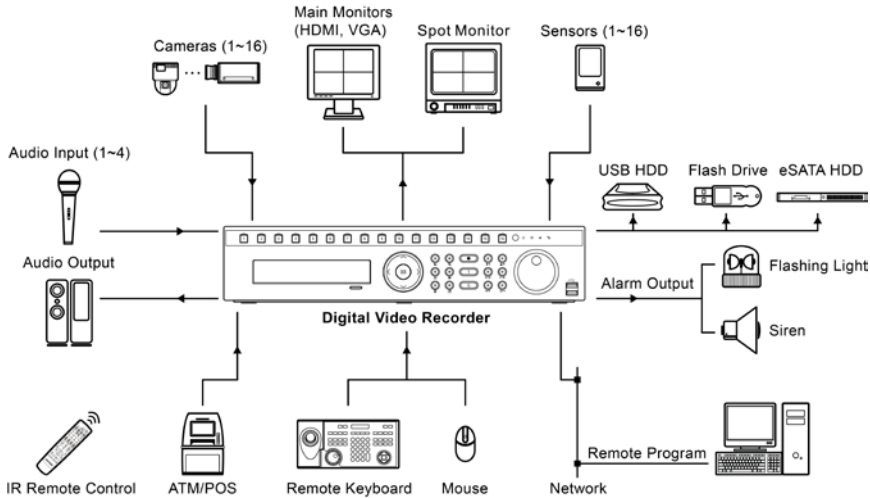

Figure 1: Typical DVR installation.

**NOTE:** This manual covers the 8- and 16-channel digital video recorders. The DVRs are identical except for the number of cameras and alarms that can be connected and the number of cameras that can be displayed. For simplicity, the illustrations and descriptions in this manual refer to the 16-camera model.

## Chapter 2 — Installation

### Package Contents

The package contains the following:

- Digital Video Recorder
- Power Cord
- Quick User Guide
- Software CD (User's Manual included)
- Rack-mount Kit
- Assembly Screws for Adding Hard Disk Drives
- SATA Cables
- Infrared Remote Control

### Required Installation Tools

No special tools are required to install the DVR. Refer to the installation manuals for the other items that make up part of your system.

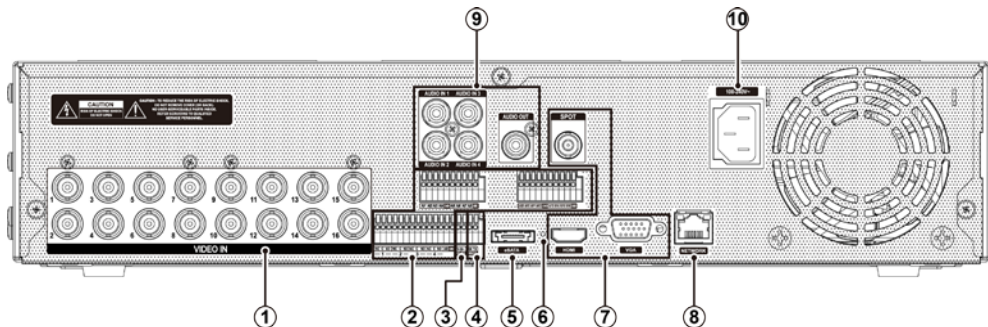

Figure 2: DVR rear panel.

- |                |                        |                        |                |
|----------------|------------------------|------------------------|----------------|
| ① Video Input  | ② Alarm Input/Output   | ③ RS485 Port           | ④ RS232 Port   |
| ⑤ eSATA Port   | ⑥ Factory Reset Switch | ⑦ Video Out            | ⑧ Network Port |
| ⑨ Audio In/Out |                        | ⑩ Power Cord Connector |                |

Your DVR can be used with either NTSC or PAL equipment.

**NOTE:** You cannot mix NTSC and PAL equipment. For example you cannot use a PAL camera and an NTSC monitor.

### Video Input



Connect the coaxial cables from the video sources to the BNC Video In connectors.

## Alarm Input/Output

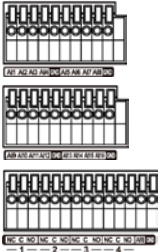

**NOTE:** To make connections on the Alarm Connector Strip, press and hold the button and insert the wire in the hole below the button. After releasing the button, tug gently on the wire to make certain it is connected. To disconnect a wire, press and hold the button above the wire and pull out the wire.

AI 1 to 16 (Alarm-In): You can use external devices to signal the DVR to react to events. Mechanical or electrical switches can be wired to the AI (Alarm-In) and GND (Ground) connectors. The threshold voltage of electrical switches for NC (Normally Closed) is above 2.4V and for NO (Normally Open) is below 0.3V, and should be stable at least 0.5 seconds to be detected. The voltage range of alarm input is from 0V to 5V. See *Chapter 3 – Configuration* for configuring alarm input.

GND (Ground): Connect the ground side of the Alarm input and/or alarm output to the GND connector.

**NOTE:** All the connectors marked GND are common.

NC/NO (Relay Alarm Outputs): The DVR can activate external devices such as buzzers or lights. Connect the device to the C (Common) and NC (Normally Closed) or C (Common) and NO (Normally Open) connectors. NC/NO is a relay output which sinks 2A@125VAC and 1A@30VDC. See *Chapter 3 – Configuration* for configuring alarm output.

ARI (Alarm Reset In): An external signal to the Alarm Reset In can be used to reset both the Alarm Out signal and the DVR's internal buzzer. Mechanical or electrical switches can be wired to the ARI (Alarm Reset In) and GND (Ground) connectors. The threshold voltage is below 0.3V and should be stable at least 0.5 seconds to be detected. Connect the wires to the ARI and GND connectors.

Connector Pin Outs:	AI (1 to 16)	Alarm Inputs 1 to 16
	GND	Chassis Ground
	NC	Relay Alarm Out (Normally Closed)
	C	Relay Common
	NO	Relay Alarm Out (Normally Open)
	ARI	Alarm Reset In

## RS485 Port



The DVR can be controlled remotely by an external device or control system, such as a control keyboard, using RS485 half-duplex serial communications signals. The RS485 connector can also be used to control PTZ (pan, tilt, zoom) cameras. Connect RX+/TX+ and RX-/TX- of the control system to the + and - (respectively) of the DVR. See *Chapter 3 – Configuration* and the PTZ camera or remote controller manufacture's manual for configuring the RS485 connection.

Connector Pin Outs:	Master Unit		Slave Unit	
	+	→ To	→	TX+/RX+
	-	→ To	→	TX-/RX-



## RS232 Port



An RS232 port is provided to connect remote control devices such as a control keyboard. PTZ cameras or text-in devices can also be connected to the RS232 port. See *Chapter 3 – Configuration* and the PTZ camera, text-in device or remote controller manufacture's manual for configuring the RS232 connection.

Connector Pin Outs:	Master Unit		Slave Unit	
	RX	→ To	→	TXD
	TX	→ To	→	RXD
	GND	→ To	→	GND

**NOTE:** Refer to the following for pin-out details for the 9-pin connector of the slave unit.

 23 5	 5 32	Pin 2	RXD (Receive Data)
Male	Female	Pin 3	TXD (Transmit Data)
		Pin 5	GND (Ground)

## eSATA Port



An eSATA port is provided to connect external storage devices for recording or archiving video. Connect the external eSATA hard disk drive (RAID) cable to the eSATA port.

**CAUTION:** Do NOT connect or disconnect eSATA devices while the DVR power is on. The DVR must be powered down to connect or disconnect eSATA devices. Power up eSATA devices so they are ready for operation before powering up the DVR. Power down eSATA devices after powering down the DVR and then disconnect eSATA devices.

## Factory Reset Switch



The DVR has a Factory Reset switch to the left of the HDMI connector on the rear panel. This switch will only be used on the rare occasions that you want to return all the settings to the original factory settings.

**CAUTION:** When using the *Factory Reset*, you will lose any settings you have saved.

To reset the unit, you will need a straightened paperclip:

1. Turn the DVR off.
2. Turn it on again.
3. Poke the straightened paperclip into the unlabeled hole to the left of the HDMI connector.
4. Hold the reset switch until the DVR's internal buzzer sounds twice.
5. Release the reset switch. All of the DVR's settings are now at the original settings it had when it left the factory.

## Video Out



An HDMI (High-Definition Multimedia Interface) connector is provided so that you can use an HDMI monitor as your main monitor.

A VGA connector is provided so that you can use a standard, multi-sync computer monitor as your main monitor. Use the cable supplied with your monitor to connect it to the DVR.

Connect the spot monitor to the SPOT connector as needed.

**NOTE:** Connect the monitor before the DVR boots so that video can be displayed on the monitor with the resolution you have set during system setup. If you want to use both the HDMI and VGA Monitor connectors, one of the monitors should be connected before the DVR boots, and the other monitor should be connected after the DVR boots.

## Network Port



The DVR can be networked using the 10Mb/100Mb/1Gb Ethernet connector. Connect a Cat5e cable with an RJ-45 jack to the DVR connector. The DVR can be networked with a computer for remote monitoring, searching, configuration and software upgrades. See *Chapter 3 – Configuration* for configuring the Ethernet connections.

**CAUTION:** The network connector is not designed to be connected directly with cable or wire intended for outdoor use.

## Audio In/Out



Your DVR can record audio from up to four sources. Connect the audio sources to Audio In 1, Audio In 2, Audio In 3 and Audio In 4 as needed using RCA jacks. Connect Audio Out to your amplifier.

**NOTE:** It is the user's responsibility to determine if local laws and regulations permit recording audio.

The DVR does not have amplified audio output, so you will need a speaker with an amplifier. The DVR does not have a pre-amplifier for audio input, so the audio input should be from an amplified source, not directly from a microphone.

## Power Cord Connector



Connect the AC power cord to the DVR and then to a wall outlet.

**WARNING:** ROUTE POWER CORDS SO THAT THEY ARE NOT A TRIPPING HAZARD. MAKE CERTAIN THE POWER CORD WILL NOT BE PINCHED OR ABRADED BY FURNITURE. DO NOT INSTALL POWER CORDS UNDER RUGS OR CARPET. THE POWER CORD HAS A GROUNDING PIN. IF YOUR POWER OUTLET DOES NOT HAVE A GROUNDING PIN RECEPTACLE, DO NOT MODIFY THE PLUG. DO NOT OVERLOAD THE CIRCUIT BY PLUGGING TOO MANY DEVICES IN TO ONE CIRCUIT.

Your DVR is now ready to operate. Refer to *Chapter 3 – Configuration* and *Chapter 4 – Operation*.

## Chapter 3 — Configuration

**NOTE:** Your DVR should be completely installed before proceeding. Refer to *Chapter 2 — Installation*.

### Front Panel Controls

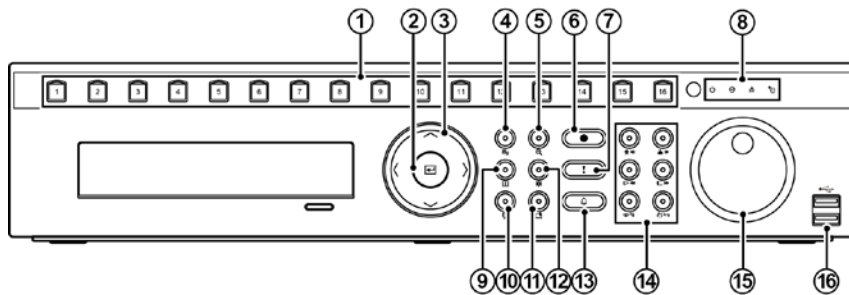

Figure 3: DVR front panel.

- |                  |                    |                     |                 |
|------------------|--------------------|---------------------|-----------------|
| ① Camera Buttons | ② Enter Button     | ③ Arrow Buttons     | ④ Menu Button   |
| ⑤ Zoom Button    | ⑥ PTZ Button       | ⑦ Panic Button      | ⑧ LED           |
| ⑨ Display Button | ⑩ Monitor Button   | ⑪ Bookmark Button   | ⑫ Freeze Button |
| ⑬ Alarm Button   | ⑭ Playback Buttons | ⑮ Jog Dial, Shuttle | ⑯ USB Port      |

The front panel looks and operates much like a VCR combined with a multiplexer. Many of the buttons have multiple functions. The buttons on the infrared remote control, while laid out differently, perform the same functions as those on the front panel. The following describes each button and control. Take a few minutes to review the descriptions. You will use these to initially set up your DVR and for daily operations.

**NOTE:** The infrared sensor on the DVR is just to the right of the arrow buttons. Make certain that nothing blocks the sensor, or the remote control will not function properly.

When you use wireless communication devices (such as Wi-Fi or Bluetooth) near the DVR, the remote control might not function properly.

You can also use a USB mouse (not supplied) to navigate through the screens and menus much like you would on a computer.

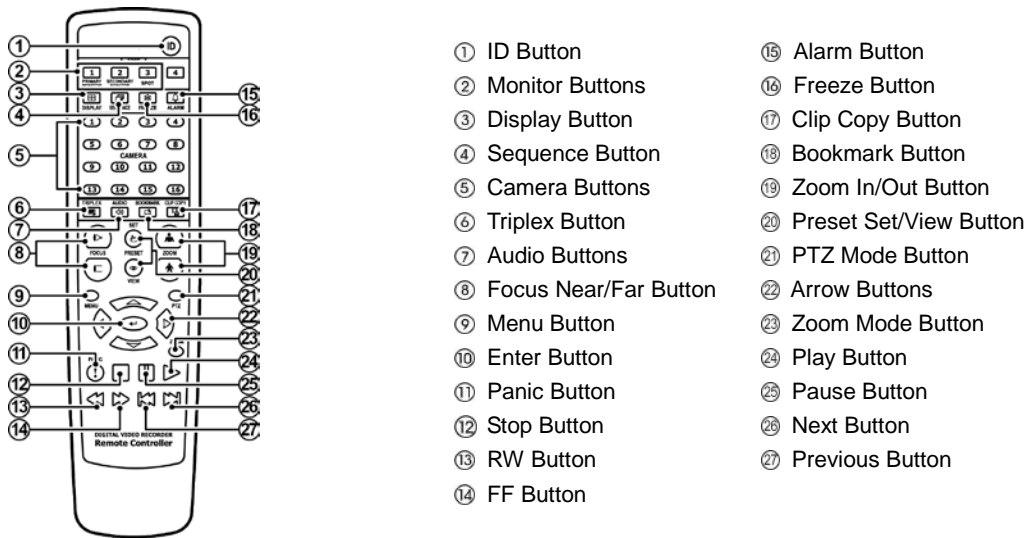



Figure 4: Infrared remote control.

**NOTE:** For simplicity, the button descriptions in this manual refer to the front panel buttons.

### Camera Buttons (1 to 16)

Pressing the individual camera buttons will cause the selected camera to display full screen.

### Enter Button

The  (Enter) button selects a highlighted item or completes an entry that you have made during system setup.

### Arrow Buttons

These buttons are used to navigate through menus and GUI. You can also use them to change numbers by highlighting a number in the menu and using the Up and Down arrow buttons to increase or decrease the number's value. These buttons are also used to control Pan and Tilt when in the PTZ mode.

When in the PIP display format, pressing the Up and Down arrow buttons moves the position of the small screen counter-clockwise and clockwise.

Pressing the Left and Right buttons moves through screen pages in the Live Monitoring mode and Search mode.

### Menu Button

Pressing the  button enters the Setup screen. You will need to enter the authorized user and password to access Setup. Pressing the button also closes the current menu or setup dialog box. In the Playback mode, pressing the button displays the Search menu. In the Search mode clip-copying can be done instantly by pressing and holding the button for three or more seconds.

### ZOOM Button

Pressing the  button zooms the current image on the screen. A PIP with a rectangle temporarily displays showing what area of the screen has been enlarged. You can use the arrow buttons to move the rectangle to another area.



## PTZ Button

Pressing the **PTZ** button enters the PTZ (Pan/Tilt/Zoom) mode which allows you to control properly configured cameras.

## Panic Button

Pressing the **PANIC** button starts panic recoding of all camera channels, and displays  on the screen. Pressing the button again will stop panic recording.

## LED

- **Power LED:** The Power LED is lit when the unit is On.
- **Network LED:** The Network LED is lit when the unit is connected to a network via Ethernet.
- **eSATA LED:** The eSATA LED is lit when an eSATA device is connected to the DVR.
- **HDD LED:** The HDD LED flickers when the DVR is recording or searching video on the hard disk drive.

## Display Button

Pressing the **DISPLAY** button toggles between different display formats. The available formats are: PIP, 2x2, 3x2, 3x3, or 4x4.

## Monitor Button

Pressing the **MONITOR** button toggles the monitor selection between Main and Spot. You can select the screen format and sequence monitoring of the selected monitor.

## Bookmark Button

When in the playback mode, pressing the **BOOKMARK** button adds the current playback point to the bookmark list or moves to the registered bookmark point.













## Freeze Button

Pressing the **FREEZE** button freezes the current live screen.





## Alarm Button

The **ALARM** button has two functions. First, it will reset the DVR's outputs including the internal buzzer during an alarm. Second, it will display the event log when you are in the live monitoring mode unless there is an active alarm.

## Playback Buttons

- **Backward:** When in the pause mode, pressing the  button moves to the previous image. The button is also used to Zoom Out while in the PTZ mode.
- **Forward:** When in the pause mode, pressing the  button moves to the next image. The button is also used to Zoom In while in the PTZ mode.
- **Rewind:** Pressing the  button plays video backward at high speed. Pressing the button again toggles the playback speed from  and . The button is also used for Near Focus in the PTZ mode.
- **Play/Pause:** Pressing the  button plays back video at regular speed. The screen displays  when the DVR is in the Pause mode and the screen displays  when the DVR is playing back video. The button is also used to save Presets while in the PTZ mode.
- **Fast Forward:** Pressing the  button plays video forward at high speed. Pressing the button again toggles the playback speed from  and . The button is also used for Far Focus in the PTZ mode.
- **Search/Stop:** Pressing the  button while in the Live Monitoring mode enters the Search mode. Pressing the  button while in the Search mode returns the DVR to the Live Monitoring mode. The button is also used to load a Preset View in the PTZ mode.

## Jog Dial, Shuttle Ring

- **Jog Dial:** When in the playback mode, you can play video forward image-by-image by turning the Jog Dial clockwise and backward image-by-image by turning the Jog Dial counterclockwise. When in the PIP mode, you can make the PIP screen smaller by turning the Jog Dial clockwise and larger by turning the Jog Dial counterclockwise. When in the Setup mode, you can change number values by highlighting the item in the menu and turning Jog Dial clockwise or counterclockwise to increase or decrease the number.
- **Shuttle Ring:** The Shuttle Ring only functions in the Playback mode. The Shuttle Ring is spring loaded and returns to the center position when released. Turning the ring clockwise plays video forward. Turning the ring counterclockwise plays video backward. Playback speed varies with the amount the ring is turned. The playback speeds are , ,  and . When you release the ring, it snaps back to the center position and the video pauses.

## USB Port

Two USB ports on the front panel are provided to connect external hard disk or flash drives for video clip copying or system upgrades. Position external drives close enough to the DVR so that you can make the cable connections, usually less than 6 feet. Use the USB cable provided with the hard disk drive to connect it to the DVR.

A USB mouse (not supplied) can be connected to one of the ports. You can use the mouse to navigate through the screens and menus much like you would on a computer.

A PostScript™ USB printer (not supplied) can be connected to one of the ports. You can print selected images resulting from a search. Refer to *Chapter 4 — Operation, Searching Video*.

A USB to Serial converter can be connected to the USB port. Multiple text-in devices can be used with a USB to Serial converter.

## ID Button on Remote Control

If a DVR System ID is set to 0, the infrared remote control will control that DVR without any additional operations. (Refer to the *System – General* setup screen in this chapter for further information on setting the System ID.) If the system ID is 1 to 16, you must to press the  button and then press the number button (1 to 16) in order to control that DVR. If the System ID of two or more DVRs is set to 0, those DVRs will react to the infrared remote control at the same time.

## Sequence Button on Remote Control

Pressing the **SEQUENCE** button displays live channels sequentially.

## Clip Copy Button on Remote Control



Pressing the **CLIP COPY** button allows you to copy video clips.

## Turning on the Power

Connecting the power cord to the DVR turns on the unit. The unit takes approximately one minute and 30 seconds to initialize.



## Initial Unit Setup

Before using your DVR for the first time, you will want to establish the initial settings. This includes items such as time and date, display language, camera, remote control, record mode, network and password. Your DVR can be set up using various screens and dialog boxes.

Throughout the screens you will see . Highlighting the  and pressing the  button gives you the opportunity to reset that screen to its default settings.



Highlighting **This page** or **All pages** and pressing the  button resets the current page or all pages of the screen to its or their default settings.

After you are finished with any setup screen, you can highlight **Save** and press the  button to save the changes and exit the screen. If you do not wish to save the changes, highlight **Cancel** and press the  button to exit the screen.

Press the **MENU** button or move the mouse pointer on the right edge of the screen and then select  (**Login**) in the Live Monitoring menu to enter the setup screens. The Login screen appears.

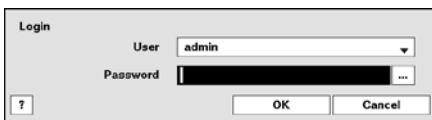



Select a User and enter the password by pressing the appropriate combination of Camera number buttons and then the  button. There is no default password when logging in the **admin** user for the first time. If you do not know the password, click the  button for guidance.

Figure 5: Login screen.

**NOTE:** To assure the secure management of the system, setting up a password is strongly recommended.

If you cannot use the front panel buttons, click the  button using the mouse to enter a password, and the virtual keyboard displays. See instructions below for using the virtual keyboard.

To log the user out of the system, press the **MENU** button or move the mouse pointer on the right edge of the screen and then select  (**Logout**) in the Live Monitoring menu. The Logout screen displays asking you to confirm whether or not you want to log out the current user.

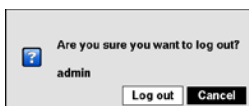
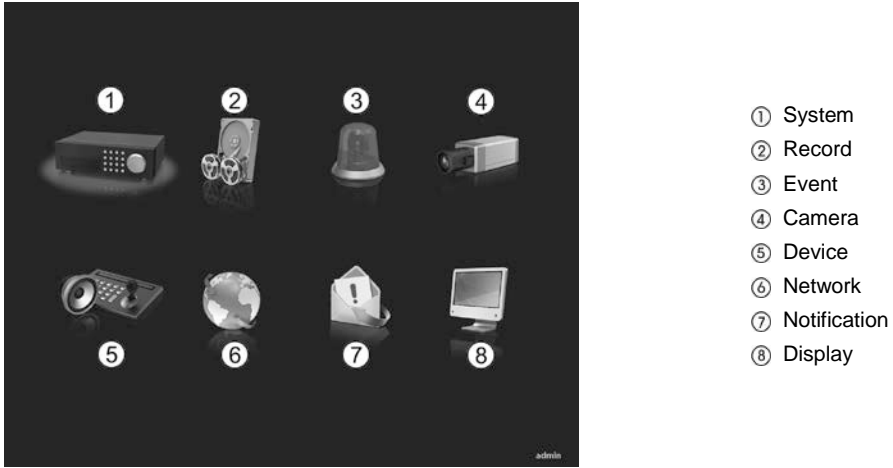



Figure 6: Logout screen.

## Setup Screen







- ① System
- ② Record
- ③ Event
- ④ Camera
- ⑤ Device
- ⑥ Network
- ⑦ Notification
- ⑧ Display

Figure 7: Setup screen.

Press the **MENU** button or move the mouse pointer on the right edge of the screen and then select  (Setup) in the Live Monitoring menu to enter the setup screen.

While setting up the DVR, there will be many opportunities to enter names and titles. When making these entries, a Virtual Keyboard will appear.



Use the arrow keys to highlight the character you want in the name or title and press the  button. That character appears in the title bar and the cursor moves to the next position. Pressing  toggles between the upper and lower case keyboards,  backspaces, and  deletes entered characters. Pressing  toggles between different keyboard layouts. You can use up to 31 characters including spaces in your title.

Special characters can be created using ^ and a capital letter; e.g., ^J for NL (New Line), ^M for CR (Carriage Return). Special characters are commonly used by text input devices and will be useful when performing Text-In Searches.

## System Setup

### General

Figure 8: System – General setup screen.

Highlight the **Site** box and press the button. A virtual keyboard appears that you can use to enter a Site Name. Once you have entered your title, highlight OK and press the button.

Highlight the box beside **System ID** and press the button. Change the number by highlighting it and using the Up and Down arrow buttons to increase and decrease the number from 0 to 99.



**NOTE:** The System ID number is used to identify the unit when it is connected with other DVRs through the RS485 port. You cannot use the same ID number for two or more DVRs that are in the same RS485 network. It is possible to have multiple DVRs with System ID 0 that are in the same area as long as they are not part of an RS485 network. If this is the case, all will be controlled at the same time when using the infrared remote control.

Highlight the box beside **Language** and press button. A drop-down menu displays the available languages. Highlight the desired language and press the button.



The box beside **Version** displays the software version of the DVR. To upgrade the software, connect a USB device containing the upgrade package file to the DVR. If you enabled the NetFS function (Network menu > NetFS tab), you can download the file from the registered NetFS site. Highlight **Upgrade...** and press the button. Select USB Storage or NetFS. If you select NetFS, select a NetFS site from the registered NetFS site list. The Upgrade screen appears. The screen displays the upgrade package file names that are available. The “.rui” indicates that the file is for software upgrades.

Select the desired file and press the button. Highlighting the **Install** button and pressing the button will install the selected software package. Highlighting the **Cancel** button and pressing the button will close the window without upgrading the software. If the upgrade package file is not installed on the DVR properly, you will get an error message. The system restarts automatically after completing the upgrade.

**CAUTION:** The USB device must be FAT16 or FAT32 format.

You can import saved DVR settings or export the current DVR settings. To import saved DVR settings, connect the USB device containing the setup file (.dat) to the DVR. If you enabled the NetFS function (Network menu > NetFS tab), you can download the setup file from the registered NetFS site. Highlight Setup – Import... and press the  button. Select USB Storage or NetFS. If you select NetFS, select a NetFS site from the registered NetFS site list. Select the desired setup file and press the Import button to import the selected settings and change the DVR settings accordingly. Highlight Include Network Setup and press the  button to toggle between On and Off. When set to Off, the network settings will not be changed.



To export the current DVR settings, connect the USB device to the DVR. If you enabled the NetFS function (Network menu > NetFS tab), you can upload the setup file on the registered NetFS site. Highlight Setup – Export... and press the  button. Select USB Storage or NetFS. If you select NetFS, select a NetFS site from the registered NetFS site list. Highlight the box beside File name and press the  button. A virtual keyboard allows you to enter the file name. Selecting Export will save the current settings in .dat file format on the USB device or the NetFS site.





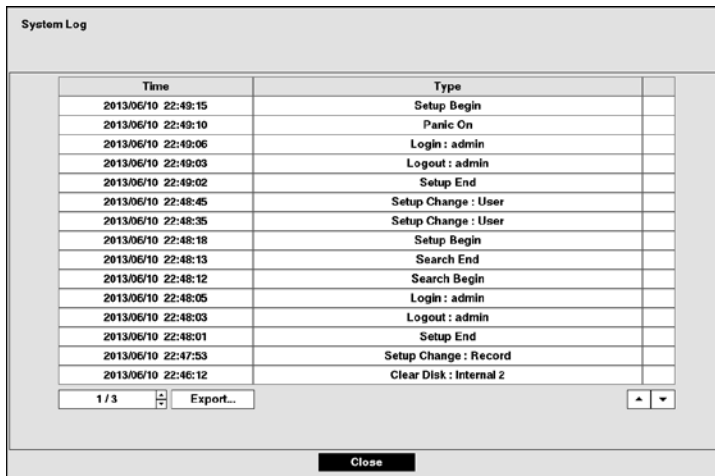

**NOTE:** Even after changing the DVR settings by importing saved settings, the time-related settings (Date/Time, Time Zone and Daylight Saving Time) will NOT be changed.

**CAUTION:** The USB device must be FAT16 or FAT32 format.

Highlight Show System Log... and press the  button to display the System Log.



The System Log screen lists system activities (up to 5,000 from the latest) that have occurred along with the time and date. The  icon will be displayed in the last column for system activities of the remote site. You can scroll through the log pages by using the Up and Down arrows, or you can go directly to a log page by entering the log page number in the box at the bottom left of the screen. Highlight Close and press the  button to exit the screen.

To export the system log information, connect the USB device to the DVR. If you enabled the NetFS function (Network menu > NetFS tab), you can upload the log information on the registered NetFS site. Highlight Export... and press the  button. Select USB Storage or NetFS. If you select NetFS, select a NetFS site from the registered NetFS site list. Highlight the box beside File name and press the  button. A virtual keyboard allows you to enter the file name. Selecting Export will save the log information in .txt file format on the USB device or the NetFS site.

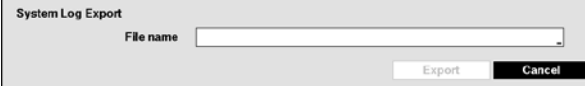

**NOTE:** When opening the saved .txt file, setting to the proper character encoding and using fixed width fonts will be required to read the file properly.

The box beside Recorded Data – From / To displays the time information of recorded data.

Highlighting Clear All Data... and pressing the  button will clear all video data. You will be asked to verify that you wish to clear all data before the DVR erases the video data. Clear All Data... will not clear the System Log.

Highlight Wizard and press the  button. The Wizard setup screen appears. The Wizard setup guides you through configuring the system for basic operation.



Select either Quick wizard or Network wizard and select the Next button to start the selected setup wizard.

**NOTE:** Selecting the *Cancel* button throughout the screens exits the Quick Setup Wizard without saving your changes and returns to the main setup screen.



If you selected the Quick wizard, selecting the Next button starts the Quick Setup Wizard.

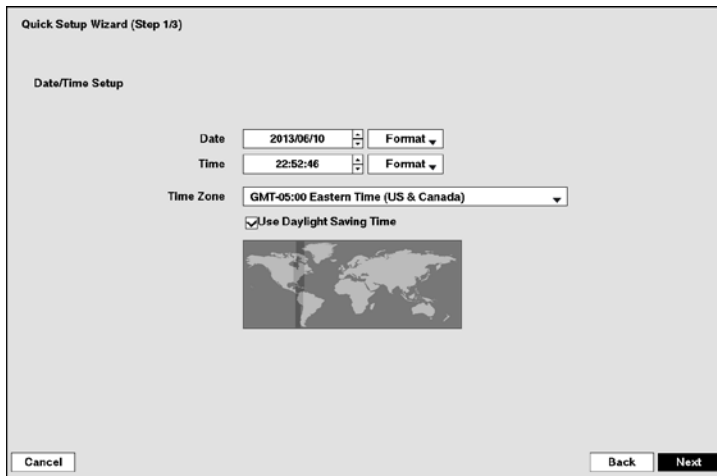

### Date/Time Setup

- **Date:** Set the system date and select the date format.
- **Time:** Set the system time and select the time format.
- **Time Zone:** Select your time zone. The Time Zone can be selected on the map.
- **Use Daylight Saving Time:** Selecting the box sets the system to use daylight saving time.

**NOTE:** The Date/Time will be set, and the clock will start when you click the **Next** button.





### Record Method Setup

- Select the desired recording mode from:
  - Motion Event Record (Recommended)
  - Continuous & Motion Event Record
  - Continuous Record

**NOTE:** You should understand each recording mode before setting the DVR's recording method.

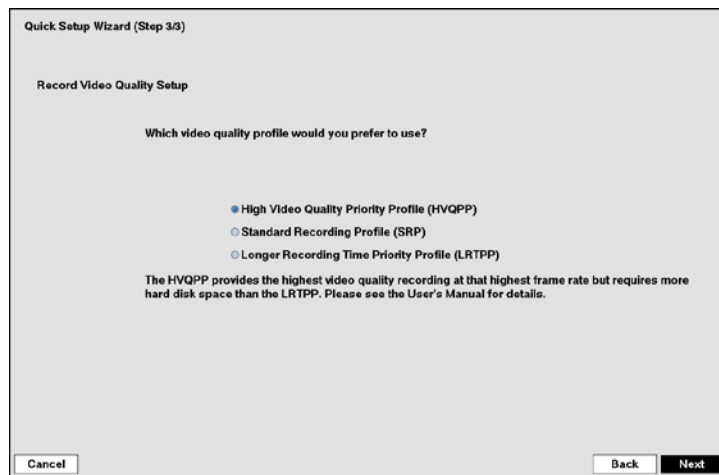

### Record Video Quality Setup

- Select the desired video quality profile from:
  - Higher Video Quality Priority Profile
  - Standard Recording Profile
  - Longer Recording Time Priority Profile

**NOTE:** The higher quality setting requires more storage space.

**NOTE:** The recording quality, recording resolution, and recording speed of each camera channel will be set as show below according to the *Record Method* and *Record Video Quality* you set.

	HVQPP*	SRP*	LRTPP*
Motion Event Record	30 ips / Very High / Very High	15 ips / High / Very High	5 ips / Standard / High
Continuous & Motion Event Record	Time, Event: 30 ips / Very High / Very High	Time: 15 ips / High / High Event: 30 ips / Very High / Very High	Time: 5 ips / Standard / High Event: 15 ips / High / High
Continuous Record	30 ips / Very High / Very High	15 ips / High / Very High	5 ips / Standard / High

\* Record Video Quality: HVQPP (High Video Quality Priority Profile), SRP (Standard Recording Profile), LRTPP (Longer Recording Time Priority Profile)



Select the Finish button to finish the Quick Setup Wizard and select the Go to Network Setup button to start the Network Setup.

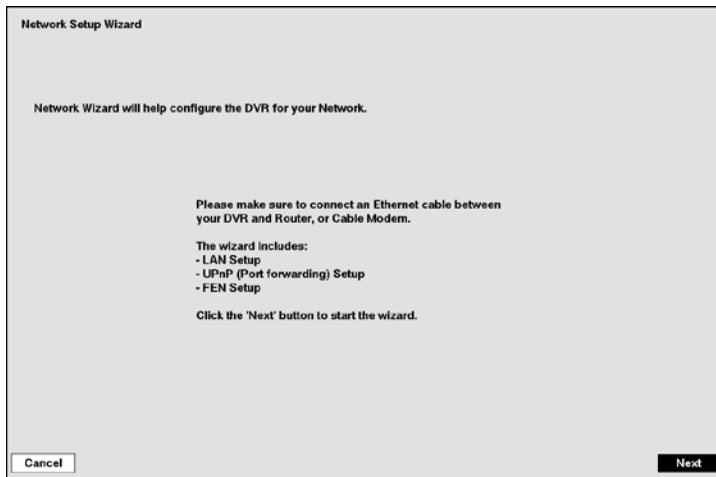

If you selected the Go to Network Setup, select the Next button to start the Network Setup Wizard.

Network Setup Wizard (Step 1/3)

Internet Connection

Is your DVR connected to the Internet?

Yes (I will use an Internet connection)

No (I will Not use an Internet connection)

Cancel Back Next

### Internet Connection

Select whether or not your DVR is connected to the Internet.

Network Setup Wizard (Step 2/3)

LAN Setup

Auto Configuration Test

Get IP, Gateway, Subnet Mask  
Search DNS Server  
Check Internet connectivity  
Search UPnP/PortForwarding

Cancel Back Next

### LAN Setup

Select between Auto Configuration and Manual Configuration for network configuration, and then select the Test button to test the network configuration you selected.

**NOTE:** Selecting *Auto Configuration* allows the DVR to automatically obtain LAN parameters (IP address, Gateway, Subnet Mask and DNS Server address). Selecting *Manual Configuration* allows you to set up LAN parameters manually.

The network configuration you set should be tested by selecting *Test*, otherwise the *Next* button will not be selected, and you cannot move to the next step.

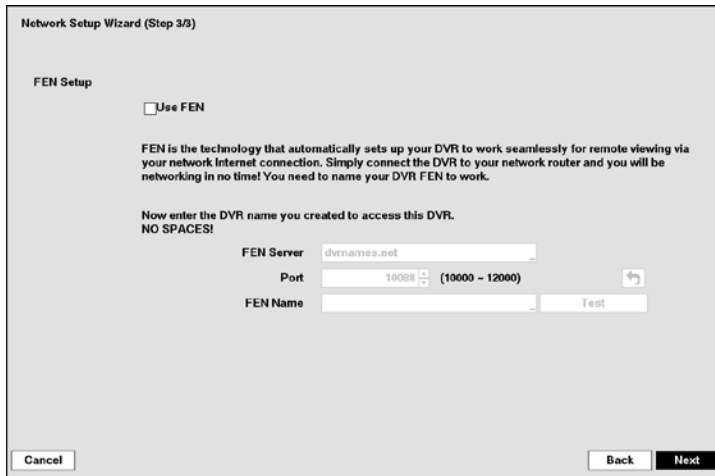

### FEN Setup

- Use FEN: Highlight and press the  button to toggle between On and Off.

**NOTE:** FEN is the technology that automatically sets up your DVR to work seamlessly for remote viewing via your network internet connection. For FEN to work, naming your DVR will be required.

- FEN Name: Enter the DVR name to be registered on the FEN server.

**NOTE:** The FEN Name you entered should be checked by selecting *Test*, otherwise the FEN changes will not be saved.

When entering no name or a name already registered on the FEN server, an error message displays.



Select the Finish button to finish the Setup Wizard.

Highlight System Shutdown and press the  button. The Shutdown screen displays asking you to confirm whether or not you want to shut the system down.

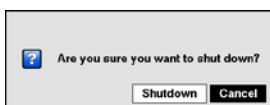

After selecting Shutdown and pressing the  button, a screen will appear telling you when it is safe to disconnect power.

## Date/Time

Figure 9: System – Date/Time setup screen.

Highlight the first box beside **Date** and press the button. The individual sections of the date will highlight. Use the Up and Down arrow buttons to change the number. Use the Left and Right arrow buttons to move between month, date and year. Once you have the correct date, press the button.

Highlight the Format box beside **Date** and press the button. Select from the three available date formats and press the button to save your selected format.

Highlight the first box beside **Time** and press the button. The individual sections of the time will highlight. Use the Up and Down arrow buttons to change the number. Use the Left and Right arrow buttons to move between hour, minutes and seconds. Once you have the correct time, press the button.

Highlight the Format box beside **Time** and press the button. Select from the three available time formats and press the button to save your selected format.

**NOTE:** The clock will not start running until you have highlighted **Save** and pressed the button.



Highlight the box beside **Time Zone** and press the button. Select your time zone from the list and press the button.

**NOTE:** The Time Zone can also be selected on the map below by pressing the Left and Right buttons or scrolling the mouse wheel up and down.

Highlight Use Daylight Saving Time and press the button. Pressing the button toggles between On and Off.

Highlighting Time Sync... and pressing the button displays the Time Sync. screen. You can set up time synchronization between the DVR and standard time servers that are available in most time zones and countries, or between the DVR and another DVR.



Highlight the box beside Automatic Sync. and press the  button. This toggles between On and Off.

Highlight the box beside Time Server and press the  button. A virtual keyboard appears that you can use to enter the IP address or domain name of the time server. Highlighting  allows you to select your time server from a list of registered time servers.

**NOTE: You can use the domain name instead of IP address if you already set up the DNS Server when setting up the LAN.**

Highlight the box beside Interval and press the  button. Set the time interval for synchronization from 30 minutes to 1 day at various time intervals.



Last Sync-Time displays the last time the DVR was synchronized with the time server.

Highlight Run as Server and press the  button. Pressing the  button toggles between On and Off. When it is On, the DVR you are setting up will run as a time server.

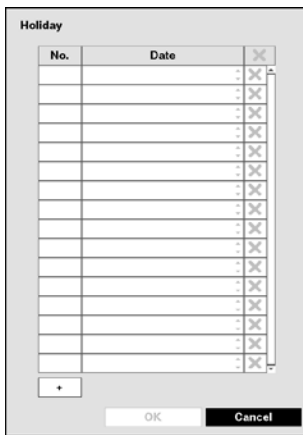
Highlighting Holiday... and pressing the  button displays the Holiday screen.



You can set up holidays by highlighting + and pressing the  button. The current date appears.

Highlight the month and day and change them by using the Up and Down arrow buttons. Press the  button to add the date. Dates can be deleted by highlighting the  beside the date and pressing the  button.

**NOTE: Holidays that do not fall on the same date each year should be updated once the current year's holiday has passed.**

## User





Figure 10: System – User setup screen.

The +/- column is used to collapse and expand user groups. If there is a + or – in this column, it indicates the item is a Group Name. If there is a – in front of the Group Name, it indicates that the group has been “expanded” and all of the User Names within that group are displayed below the Group Name. If there is a + in front of the Group Name, it indicates that the group has been “collapsed” and all of the User Names within that group are hidden. To collapse or expand a group, highlight the +/- column in front of the desired group and press the  button.

Highlighting a Group Name and pressing the  button allows you to change the authority levels assigned to the group.

**CAUTION: Write down the new password and save it in a secure place. If the password is forgotten, the unit must be reset using the *Factory Reset Button* and all data settings will be lost.**

Highlighting a User Name and pressing the  button allows you to add or change the password assigned to that user. You can also change the group to which the user is assigned.

The ✕ column can be used to delete a User Name or an entire Group. If the ✕ is grayed out, that Group or User cannot be deleted. Highlight the ✕ and press the  button. You will be asked to confirm that you want to delete the User or Group. To delete the User currently logged into the DVR on a local system or a PC running RAS, log the user out of the system first and then delete the user.

To add a Group, highlight the + Group... box and press the  button. A virtual keyboard appears allowing you to enter the Group name. You can use up to 15 characters including spaces in the group name. Enter the name and assign authority levels to the group.



Highlighting the Authority box and pressing the  button will toggle between all authority levels being turned On and Off.

Highlighting the individual authority level boxes and pressing the  button will toggle between that authority level being turned On and Off. The authority levels that can be turned On and Off are:

- Shutdown – The user can shut the system down on a local system.
- Upgrade – The user can upgrade the software on a local system or a PC running RAS.
- Color Control – The user can control brightness, contrast, hue and saturation for cameras on a local system or a PC running RAS.
- System Check – The user can view the remote system status or check the remote system status as a batch process on a PC running RAS.
- PTZ Control – The user can control the PTZ camera on a local system or a PC running RAS.
- Alarm-Out Control – The user can reset the DVR’s outputs including the internal buzzer during an alarm by pressing the any button on the front panel on a local system or alarm-out control button on a PC running RAS.

- Covert Camera View – The user can view video from cameras set as Covert while in the Live Monitoring or Search mode on a local system or a PC running RAS.
- Search – The user can access the Search mode on a local system or a PC running RAS.
- Clip-Copy – The user can copy video clips on a local system or a PC running RAS.
- Setup – The user without Setup authority cannot establish any system settings excluding system shutdown and logout on a local system or a PC running RAS.
- System Time Change – The user can change the system date and time on a local system or a PC running RAS.
- Data Clear – The user can clear all video data or format disks on a local system or a PC running RAS.
- PTZ Setup – The user can establish all PTZ settings on a local system or a PC running RAS.
- Alarm-Out Setup – The user can establish all Alarm-Out settings on a local system or a PC running RAS.
- Covert Camera Setup – The user can establish all Covert Camera settings on a local system or a PC running RAS.
- Record Setup – The user can establish all Record settings on a local system or a PC running RAS.
- Setup Import – The user can import saved DVR settings from a local system or a PC running RAS.
- Setup Export – The user can export the current DVR settings to a local system or a PC running RAS.
- VNC Setup – The user can establish all VNC settings on a local system or a PC running RAS.



The screenshot shows a 'New User' dialog box with the following fields and controls:

- User:** A text input field containing a blacked-out name.
- Group:** A dropdown menu currently showing 'Administrator'.
- Password:** A text input field with a small '...' button to its right.
- Confirm:** A text input field with a small '...' button to its right.
- Buttons:** 'OK' and 'Cancel' buttons at the bottom.

To add a User, highlight the + User... box and press the  button. A virtual keyboard appears allowing you to enter the User Name. Enter the name and assign the User to a Group and password. The password can be up to 8 digits. You will be asked to confirm the password.

**NOTE:** In addition to using the front panel buttons or the infrared remote control, you can use the virtual keyboard to assign the password. To display the virtual keyboard click the  button using the mouse (not supplied).

Highlighting the box beside Auto Login allows you to select a User to be automatically logged in when the DVR is powered up. It can also be set to never automatically login a user.

Highlighting the box beside Auto Logout allows you to select from a list of times that the user will be automatically logged out. The options are: Never, 1 min., 3 min., 5 min., 10 min., 15 min., 20 min., 30 min. and 1 hr.



## Storage

< RAID Non-Supported Models >

SYSTEM			
General	Date/Time	User	Storage
Type	Capacity	Format	Information
Internal 1	1.00 TB	Record	In Use
Internal 2	1.00 TB	Record	In Use

Save Cancel

< RAID Supported Models >

SYSTEM			
General	Date/Time	User	Storage
Type	Capacity	Format	Information
Mirror 1	1.00 TB	Record	In Use
Mirror 2	1.00 TB	Record	In Use

Mirror

No.	Internal HDD	Setup	Information
1	1 - 2	Mirroring	In Use
2	3 - 4	Mirroring	In Use

Save Cancel

Figure 11: System – Storage setup screen.

The information in the Type column describes the storage device.

The capacity of the storage device is displayed in the Capacity column.

The Format column displays whether the device is used for recording (Record) or not (Not Using). Not formatted indicates the device is not formatted.

Internal 1 - 1.00 TB  
Use As: Record  
Format Cancel

Highlight the box in the Format column for the desired storage device and press the button. You will be able to format the device for recording. When selecting Not Using from Use As and highlighting the Format button, the device will not be used for recording.

The Information column displays whether the device is being used or not. Other indicates the device has been used for another DVR.

Highlight the box in the Information column for the desired storage device and press the **←** button.

You will be able to check the model name, serial number and the time information about recorded data of the selected storage device.

If you want to erase recorded data on the selected device, highlight Clear and press the **←** button. You will be asked whether or not you want to delete the data.

Highlight the box in the Setup column and press the **←** button(RAID supported models only). The DVR can be set up to record the same data on the two disks at the same time. Refer to the *Chapter 4 – Disk Mirroring* for further information on setting up disk mirroring.

## System Event

Event	Settings	Actions
System	Never	<input type="checkbox"/>
Boot Up		<input type="checkbox"/>
Restart		<input type="checkbox"/>
Shutdown		<input type="checkbox"/>
Panic Record		
Check Recording	Off	<input type="checkbox"/> <input type="checkbox"/>
Check Alarm-In	Off	<input type="checkbox"/> <input type="checkbox"/>
Disk Almost Full	90%	<input type="checkbox"/> <input type="checkbox"/>
Disk Full		<input type="checkbox"/> <input type="checkbox"/>
Disk Bad	50%	<input type="checkbox"/> <input type="checkbox"/>
Disk Temperature	70°C	<input type="checkbox"/> <input type="checkbox"/>
Disk S.M.A.R.T.		<input type="checkbox"/> <input type="checkbox"/>
Disk Config Change		<input type="checkbox"/> <input type="checkbox"/>
Fan Error		<input type="checkbox"/> <input type="checkbox"/>
No Storage Found		<input type="checkbox"/> <input type="checkbox"/>

Figure 12: System – System Event setup screen.



The DVR can be configured to run self-diagnostics and report the results.

Highlight the Settings box beside the desired event (System, Check Recording, Check Alarm-In, Disk Almost Full, Disk Bad, or Disk Temperature), and press the **←** button.

Highlight the Settings box beside System and press the **←** button. You can select the interval that you want the DVR to run self-diagnostics on the system. You can select from 1 hr. to 30 days or Never.

Highlight the **Settings** box beside **Check Recording** and press the  button. The **Check Recording** screen appears.

No.	Day	Range	Interval	X
1	All	00:00 - 24:00	1 min.	X
				X
				X
				X
				X
				X
				X
				X
				X
				X
				X
				X
				X
				X
				X
				X
				X

Highlighting **Schedule On** and pressing the  button toggles **On** and **Off**. When set to **On**, you can select the day, time range and interval that you want the DVR to run self-diagnostics on the recorder. The Interval can be selectable from 1 min. to 7 days or **Never**. Highlight the **+** and press the  button to add a schedule item. The **X** box allows you to delete a check recording schedule.

Highlight the **Settings** box beside **Check Alarm-In** and press the  button. You can select the interval that you want the DVR to run self-diagnostics on Alarm Inputs. You can select from 1 hr. to 30 days or **Never**.

Highlight the **Settings** box beside **Disk Almost Full**, and press the  button. Select the percentage level of disk usage at which you want the DVR to trigger an alert. Percentage levels range from 80% to 99%.

Highlight the **Settings** box beside **Disk Bad**, and press the  button. Select percentage level of bad disk sectors at which you want the DVR to trigger an alert. Percentage levels range from 10% to 90%.

Highlight the **Settings** box beside **Disk Temperature**, and press the  button. Select the temperature of hard disk drive at which you want the DVR to trigger an alert if the temperature exceeds the defined threshold. Refer to the hard disk drive manufacturer's documentation for the correct temperature setting.

The DVR can be set to react to system events. Highlight the **Actions** box beside the desired event and press the  button. System events can be associated with an Alarm-Out connector, sound the DVR's internal buzzer, and/or notify a number of different devices.

- NOTE:** **Alarm-Out** action cannot be set to **System, Boot Up, Restart, Shutdown and Panic Record** events.  
**Mail** notify is the only option available for the **System** event.  
**Alert Window** notify cannot be set to **System, Boot Up, Restart and Shutdown** events.  
**For the Notify** action to work, the DVR should be registered in the **RAS (Remote Administration System)**.

## Recording Setup

### General



Figure 13: Record – General setup screen.

Highlighting **Recycle** and pressing the  button toggles between On and Off. In the Recycle mode, the DVR records over the oldest video data once all available storage space has been used. When Recycle is turned off, the DVR stops recording once all available storage space has been used.

Highlight the **Event Record Dwell** box and set the length of time you would like to record for the associated event. You can set the dwell from 5 seconds to 30 minutes. Refer to *Event Actions* screen in this chapter for information regarding event recording.

The DVR can record up to four audio inputs. Highlighting **Record Audio** and pressing the  button toggles between On and Off.

Highlight the slide bar beside **Auto Deletion**, and use the Left and Right arrow buttons or Up and Down arrow buttons to adjust the length of time recorded data will be kept from 1 to 999 days. The DVR automatically deletes video recorded earlier than the user-defined period under three conditions: at midnight, whenever the system reboots or whenever the user changes the Auto Deletion settings. Selecting **Never** will disable the Auto Deletion function.

Highlight the slide bar beside **Limit Time-Lapse Recording**, and use the Left and Right arrow buttons to adjust the length of the maximum storage time for time-lapse recording from 1 to 99 days. The Limit Time-Lapse Recording feature will function when the storage device has enough space to record video data longer than the preset period. When this feature is On, the DVR records over the oldest “time-lapse” video once all available storage has been used in the Recycle mode, so more event video can be saved. Selecting **Never** will disable the Limit Time-Lapse Recording function.

**NOTE:** When the storage device does not have enough space to record video data longer than the preset Limit Time-Lapse Recording period, the DVR records over the oldest video data (time-lapse or event video) as it would in the Recycle mode even if this feature is turned On.

The maximum storage time is only an estimate because the amount of space required to store video varies depending on many factors such as motion and image complexity.

Highlighting **Use Panic Recording** and pressing the  button toggles between On and Off.

Highlight the **Panic Recording – Duration** box and set the duration of panic recording. Panic recording will stop automatically after the preset duration as long as the **PANIC** button is not pressed to stop the panic recording. You can set the dwell from 5 minutes to 1 hour. Select **No Limit** if you want to stop panic recording manually.

Highlighting the Panic Recording – ips and pressing the  button allows you to set the images per second for Panic recording. You can select from 1.00 to 30.00 ips (25.00 ips PAL).

Highlighting the Panic Recording – Quality and pressing the  button allows you to set the recorded image quality for Panic recording. You can select from: Very High, High, Standard and Basic.

Highlighting the Panic Recording – Resolution and pressing the  button allows you to set the recorded image resolution for Panic recording. You can select from: Very High, High and Standard.

## Schedule

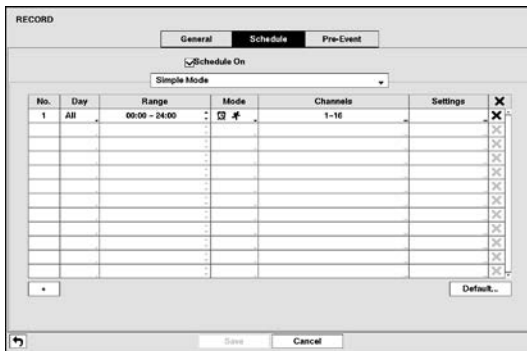



< Simple Mode >



< Advanced Mode >

Figure 14: Record – Schedule setup screen.

You can program the DVR to record only during certain times based on time, day of the week, and holidays. The smallest time segment you can use is 15 minutes.

Highlighting Schedule On and pressing the  button toggles between On and Off. In the Schedule On mode, the DVR records video based on the schedule established in the Schedule screen. When turning Schedule recording Off, you will be asked to confirm your decision, and  displays at the top-left corner of each camera screen. Panic recording will function even when Schedule is turned off.  displays during panic recording.

Highlight the Schedule Mode box and press the  button. You can select between Simple Mode and Advanced Mode. Selecting Advanced Mode allows you to set up individual recording schedule for each event.

**NOTE: Changing the schedule mode will reset all event and action statuses.**



Highlight the + and press the  button to add a schedule item.





Highlight the box under the Day heading and press the  button to change the days that the scheduled recording will take place. Choose from: Sun, Mon, Tue, Wed, Thu, Fri, Sat, M-F, Hol and All.



Highlight the box under the Range heading and press the  button to change the time range that the scheduled recording will take place. The smallest time segment you can use is 15 minutes.

Highlight the box under the Mode heading and press the  button to change the recording mode that will be used. Choose from: No Record, Time, Event and Time & Event. (Simple Mode Only)

When the DVR is in the No Record mode, it will not record during the preset day and time range as long as the **PANIC** button is not pressed. Use the No Record mode when you do NOT want the DVR to record during certain times.

When the DVR is in the Time mode, the  icon displays at the top-left corner of the screen. The DVR will record and displays the  icon at the top-left corner of the screen during the scheduled times.

When the DVR is in the Event mode, the red  icon displays at the top-left corner of the screen. The DVR will record and displays the  icon at the top-left corner of the screen when any event occurs. When the DVR is in the Pre-Event recoding mode, the yellow  icon displays when there is no event, and the DVR is not recording. When the DVR is in the Pre-Event mode, the red  and  display when any event occurs and the DVR starts recoding.

When the DVR is in the Time & Event mode, the DVR will follow the Time settings and the  icon displays at the top-left corner of the screen. The DVR follows the Event settings and the  icon displays.

Highlight the box under the Channels heading and press the  button to select which cameras will be recorded. (Simple Mode Only)

Highlight the box under the Settings heading and press the  button to define the recording settings.

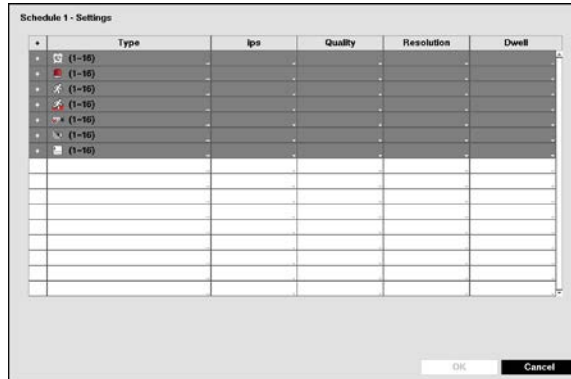









Figure 15: Schedule – Settings (Advanced Mode) setup screen.



You can set the ips, Quality and Resolution (ips, Quality, Resolution and Dwell for Advanced Mode setup) of the recording for any modes you set up in the Mode column. If you do not set the ips, Quality, Resolution and Dwell in the Settings column, the DVR will follow the default settings. See below for details.

**NOTE: Descriptions of the Record icons in the Type column are as follows:**

-  Time-lapse (Time)     Alarm-In     Motion     Tripzone
-  Video Loss     Video Blind     Text-In

**Channels that are not defined will use the setting values of the previous schedule item.**

**NOTE: When multiple events are detected at the same time from a specific channel, the DVR will record event video with the high setting values if the ips, Quality, Resolution and Dwell values of events are different from each other. However, the ips will be reset to the supported maximum value when the ips, Quality, Resolution and Dwell are all set to the highest value. (Advanced Mode Only)**

Highlight the box under the  heading and press the  button to delete the recording settings. You will be asked to confirm that you want to delete the settings.

**NOTE: The resolution can be set up at a time for each event or separately for each channel of an event (Advanced Mode only). When setting up at a time for each event, the following options are available: *Very High*, *High* and *Standard*. Selecting *Very High*, the highest resolution will be applied. Selecting *Standard*, the lowest resolution, and selecting *High*, the other resolution will be applied. When setting up separately for each channel of an event, you can select any resolution supported by the camera mode (720, 960, HD, or Full HD).**

<div style="background-color: #333; color: white; padding: 2px; font-weight: bold;">▼ (Standard)</div> <table border="1" style="width: 100%; border-collapse: collapse;"> <tr><td style="padding: 2px;">Very High</td></tr> <tr><td style="padding: 2px;">High</td></tr> <tr><td style="padding: 2px;">Standard</td></tr> </table>	Very High	High	Standard	<div style="background-color: #333; color: white; padding: 2px; font-weight: bold;">▼ (360x240)</div> <table border="1" style="width: 100%; border-collapse: collapse;"> <tr><td style="padding: 2px;">720x480</td></tr> <tr><td style="padding: 2px;">720x240</td></tr> <tr><td style="padding: 2px;">360x240</td></tr> </table>	720x480	720x240	360x240	<div style="background-color: #333; color: white; padding: 2px; font-weight: bold;">▼ (480x240)</div> <table border="1" style="width: 100%; border-collapse: collapse;"> <tr><td style="padding: 2px;">960x480</td></tr> <tr><td style="padding: 2px;">960x240</td></tr> <tr><td style="padding: 2px;">480x240</td></tr> </table>	960x480	960x240	480x240	<div style="background-color: #333; color: white; padding: 2px; font-weight: bold;">▼ (720x480)</div> <table border="1" style="width: 100%; border-collapse: collapse;"> <tr><td style="padding: 2px;">1280x720</td></tr> <tr><td style="padding: 2px;">720x480</td></tr> <tr><td style="padding: 2px;">360x240</td></tr> </table>	1280x720	720x480	360x240	<div style="background-color: #333; color: white; padding: 2px; font-weight: bold;">▼ (720x480)</div> <table border="1" style="width: 100%; border-collapse: collapse;"> <tr><td style="padding: 2px;">1920x1080</td></tr> <tr><td style="padding: 2px;">1280x720</td></tr> <tr><td style="padding: 2px;">720x480</td></tr> </table>	1920x1080	1280x720	720x480
Very High																			
High																			
Standard																			
720x480																			
720x240																			
360x240																			
960x480																			
960x240																			
480x240																			
1280x720																			
720x480																			
360x240																			
1920x1080																			
1280x720																			
720x480																			
< Event >	< 720 Mode >	< 960 Mode >	< HD Mode >	< Full HD Mode >															

Highlight Default... and press the  button. The Default screen appears.

Default				
Mode	ips	Quality	Resolution	Dwell
Time	30.00 ips	High	High	
Event	30.00 ips	Very High	Very High	5 sec.



Highlighting boxes under ips and pressing the  button allows you to set the images per second for Time and Event recording. You can select from 1.00 to 30.00 ips (25.00 ips PAL).

Highlighting boxes under Quality and pressing the  button allows you to set the recorded image quality for Time and Event recording. You can select from: Very High, High, Standard and Basic.

Highlighting boxes under Resolution and pressing the  button allows you to set the recorded image resolution for Time and Event recording. You can select from: Very High, High and Standard.

Highlighting boxes under Dwell and pressing the  button allows you to set the length of time you would like to record for the associated event. (Advanced Mode Only)

## Pre-Event

RECORD				
General				
Schedule				
Pre-Event				
No.	ips	Quality	Resolution	Dwell
<input checked="" type="checkbox"/> 1	30.00 ips	Standard	720X480	00 min. 05 sec.
<input checked="" type="checkbox"/> 2	30.00 ips	Standard	720X480	00 min. 05 sec.
<input checked="" type="checkbox"/> 3	30.00 ips	Standard	720X480	00 min. 05 sec.
<input checked="" type="checkbox"/> 4	30.00 ips	Standard	720X480	00 min. 05 sec.
<input checked="" type="checkbox"/> 5	30.00 ips	Standard	720X480	00 min. 05 sec.
<input checked="" type="checkbox"/> 6	30.00 ips	Standard	720X480	00 min. 05 sec.
<input checked="" type="checkbox"/> 7	30.00 ips	Standard	720X480	00 min. 05 sec.
<input checked="" type="checkbox"/> 8	30.00 ips	Standard	720X480	00 min. 05 sec.
<input checked="" type="checkbox"/> 9	30.00 ips	Standard	720X480	00 min. 05 sec.
<input checked="" type="checkbox"/> 10	30.00 ips	Standard	720X480	00 min. 05 sec.
<input checked="" type="checkbox"/> 11	30.00 ips	Standard	720X480	00 min. 05 sec.
<input checked="" type="checkbox"/> 12	30.00 ips	Standard	720X480	00 min. 05 sec.
<input checked="" type="checkbox"/> 13	30.00 ips	Standard	720X480	00 min. 05 sec.
<input checked="" type="checkbox"/> 14	30.00 ips	Standard	720X480	00 min. 05 sec.
<input checked="" type="checkbox"/> 15	30.00 ips	Standard	720X480	00 min. 05 sec.
<input checked="" type="checkbox"/> 16	30.00 ips	Standard	720X480	00 min. 05 sec.



Figure 16: Record – Pre-Event setup screen.

When the DVR is in the Event Record mode it is possible to have it record images before the event occurs. The Pre-Event screen allows you to define how to handle pre-event recording. If you do not have Event set up in the Record Schedule, a message will display alerting you to this fact.

You can turn individual cameras On or Off for pre-event recording. The image speed can be set from 1.00 to 30.00 ips (25.00 ips PAL), image quality can be selectable from Very High, High, Standard and Basic, and image resolution can be selectable from Very High, High and Standard.

You can set the amount of time to record prior to the event by adjusting the Dwell. You can set the Dwell from 5 seconds to 30 minutes. The longer the dwell set, the fewer maximum ips can be set.

**NOTE: When the DVR is in the Time or Time & Event mode, it ignores the pre-event settings and follows the time settings.**

## Event Setup

### Motion

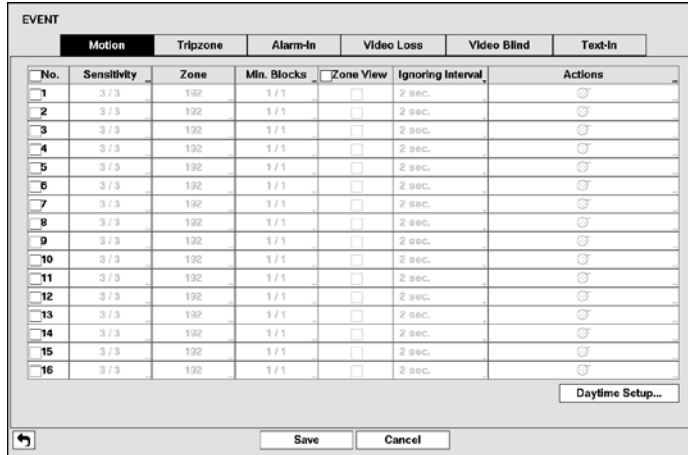
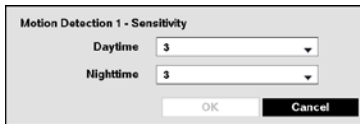

Figure 17: Event – Motion setup screen.

Your DVR has built-in video motion detection. Video motion detection can be turned On or Off for each camera.



Highlighting the box under the Sensitivity heading and pressing the button allows you to adjust the DVR's sensitivity to motion for Daytime and Nighttime independently. There are five settings with 1 being the least sensitive and 5 being the most sensitive.

You can define the area of the image where you want to detect motion; e.g., a doorway. Highlight the box under the Zone heading, and press the button. The Motion Zone screen displays.

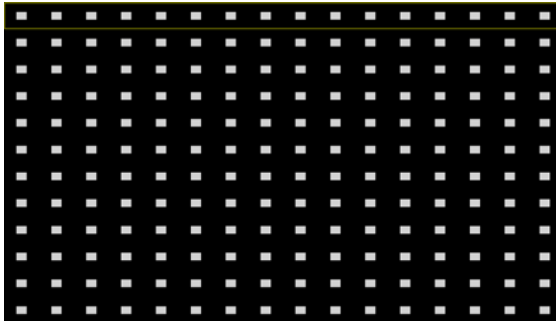

The Motion Zone screen is laid over the video for the selected camera. You can set up motion zones by selecting or clearing blocks.

**NOTE:** You can set up motion zones one block at a time in groups of 16 individual block groups. A block group is positioned within the image area using the Up and Down arrow buttons, and individual blocks within the block groups are selected or cleared using the camera buttons.

Press the button to display the menu screen. The menu on the setup screen has the following functions:

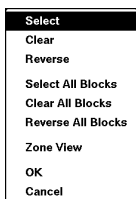

- Select – Activates highlighted blocks to detect motion.
- Clear – Deactivates highlighted blocks so that they will not detect motion.
- Reverse – Activates inactive highlighted blocks and deactivates active highlighted blocks.
- Select All Blocks – Activates all blocks to detect motion.
- Clear All Blocks – Deactivates all blocks so that they will not detect motion.
- Reverse All Blocks – Activates inactive blocks and deactivates active blocks.
- Zone View – Displays any detected motion within the zone in red.
- OK – Accepts changes and closes Zone setup.
- Cancel – Exits Zone setup without saving changes.



You can adjust the minimum number of detection blocks that must be activated to trigger a motion alarm. Highlighting the box under the **Min. Blocks** heading and pressing the  $\leftarrow$  button allows you to adjust the minimum number of detection blocks for Daytime and Nighttime independently. Smaller numbers provide greater sensitivity because fewer detection blocks must be activated.

Turning **Zone View On** will allow you to observe how the DVR is reacting to motion. When in the motion viewing mode, the detection zone of video will be displayed. Any detected motion within the zone will be displayed in red.

Highlight the box under the **Actions** and press the  $\leftarrow$  button. The DVR can be set to react to motion differently for each camera. Each camera can be associated with another camera, trigger an Alarm-Out connector, sound the DVR's internal buzzer, notify a number of different devices, and/or move PTZ cameras to preset positions.

You can control excessive event logging and remote notification of motions detected after the motion dwell time by adjusting the motion ignoring dwell intervals. Highlight the box beside **Motion Ignoring Interval** and press the  $\leftarrow$  button. A list of intervals ranging from 1 to 10 seconds or **Never** appears. The DVR will not log and notify motion events occurred during the preset interval range.

**NOTE: The record action for motion events will not be affected by the Motion Ignoring function.**

Highlighting **Daytime Setup** and pressing the  $\leftarrow$  button allows you to set up the Daytime range.

Highlight the box beside **Daytime** and press the  $\leftarrow$  button. Use the Up and Down arrow buttons to set the Daytime range. The DVR will consider the remaining time range as the Nighttime.

## Tripzone

EVENT						
	Motion	Tripzone	Alarm-In	Video Loss	Video Blind	Text-In
No.	Sensitivity	Zone	Zone View	Ignoring Interval	Actions	
1	3/3	192	<input type="checkbox"/>	2 sec.	🔍, 📢	
2	3/3	192	<input type="checkbox"/>	2 sec.	🔍, 📢	
3	3/3	192	<input type="checkbox"/>	2 sec.	🔍, 📢	
4	3/3	192	<input type="checkbox"/>	2 sec.	🔍, 📢	
5	3/3	192	<input type="checkbox"/>	2 sec.	🔍, 📢	
6	3/3	192	<input type="checkbox"/>	2 sec.	🔍, 📢	
7	3/3	192	<input type="checkbox"/>	2 sec.	🔍, 📢	
8	3/3	192	<input type="checkbox"/>	2 sec.	🔍, 📢	
9	3/3	192	<input type="checkbox"/>	2 sec.	🔍, 📢	
10	3/3	192	<input type="checkbox"/>	2 sec.	🔍, 📢	
11	3/3	192	<input type="checkbox"/>	2 sec.	🔍, 📢	
12	3/3	192	<input type="checkbox"/>	2 sec.	🔍, 📢	
13	3/3	192	<input type="checkbox"/>	2 sec.	🔍, 📢	
14	3/3	192	<input type="checkbox"/>	2 sec.	🔍, 📢	
15	3/3	192	<input type="checkbox"/>	2 sec.	🔍, 📢	
16	3/3	192	<input type="checkbox"/>	2 sec.	🔍, 📢	

Figure 18: Event – Tripzone setup screen.

Your DVR has built-in video Tripzone detection. Video Tripzone detection can be turned On or Off for each camera.

Highlighting the box under the **Sensitivity** heading and pressing the  $\leftarrow$  button allows you to adjust the DVR's sensitivity to motion for Daytime and Nighttime independently. There are five settings with 1 being the least sensitive and 5 being the most sensitive.

You can define the area of the image where you want to detect motion; e.g., a doorway. Highlight the box under the **Zone** heading, and press the  $\leftarrow$  button. The **Motion Zone** screen displays.

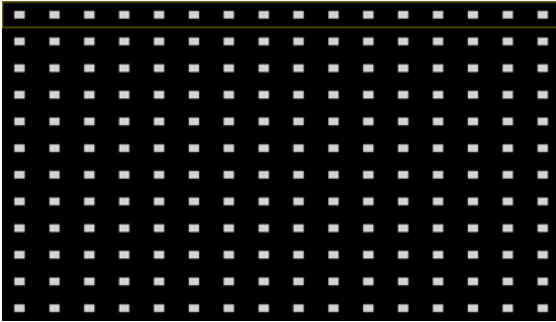

The Motion Zone screen is laid over the video for the selected camera. You can set up motion zones by selecting or clearing blocks.

**NOTE:** You can set up motion zones one block at a time in groups of 16 individual block groups. A block group is positioned within the image area using the Up and Down arrow buttons, and individual blocks within the block groups are selected or cleared using the camera buttons.

Press the  button to display the menu screen. The menu on the setup screen has the following functions:

- Select
- Clear
- Reverse
- Select All
- Clear All
- Reverse All
- Zone View
- OK
- Cancel

- Select – Activates highlighted blocks to detect motion.
- Clear – Deactivates highlighted blocks so that they will not detect motion.
- Reverse – Activates inactive highlighted blocks and deactivates active highlighted blocks.
- Select All – Activates all blocks to detect motion.
- Clear All – Deactivates all blocks so that they will not detect motion.
- Reverse All – Activates inactive blocks and deactivates active blocks.
- Zone View – Displays any detected motion within the zone in red.
- OK – Accepts changes and closes Zone setup.
- Cancel – Exits Zone setup without saving changes.

Turning Zone View On will allow you to observe how the DVR is reacting to motion. When in the motion viewing mode, the detection zone of video will be displayed. Inward motion from outside the zone will be displayed in blue.

Highlight the box under the Actions and press the  button. The DVR can be set to react to motion differently for each camera. Each camera can be associated with another camera, trigger an Alarm-Out connector, sound the DVR's internal buzzer, notify a number of different devices, and/or move PTZ cameras to preset positions.

You can control excessive event logging and remote notification of Tripzone events detected after the Tripzone dwell time by adjusting the Tripzone ignoring dwell intervals. Highlight the box beside Tripzone Ignoring Interval and press the  button. A list of intervals ranging from 1 to 10 seconds or Never appears. The DVR will not log and notify Tripzone events occurred during the preset interval range.

**NOTE:** The record action for motion events will not be affected by the Tripzone Ignoring function.

Highlighting Daytime Setup and pressing the  button allows you to set up the Daytime range.



Highlight the box beside Daytime and press the  button. Use the Up and Down arrow buttons to set the Daytime range. The DVR will consider the remaining time range as the Nighttime.

## Alarm-In

EVENT

	Motion	Tripzone	Alarm-In	Video Loss	Video Blind	Text-In
No.	Title			Type	Actions	
1	Alarm-In 1			NC	⊕, ⊖	
2	Alarm-In 2			NC	⊕, ⊖	
3	Alarm-In 3			NC	⊕, ⊖	
4	Alarm-In 4			NC	⊕, ⊖	
5	Alarm-In 5			NC	⊕, ⊖	
6	Alarm-In 6			NC	⊕, ⊖	
7	Alarm-In 7			NC	⊕, ⊖	
8	Alarm-In 8			NC	⊕, ⊖	
9	Alarm-In 9			NC	⊕, ⊖	
10	Alarm-In 10			NC	⊕, ⊖	
11	Alarm-In 11			NC	⊕, ⊖	
12	Alarm-In 12			NC	⊕, ⊖	
13	Alarm-In 13			NC	⊕, ⊖	
14	Alarm-In 14			NC	⊕, ⊖	
15	Alarm-In 15			NC	⊕, ⊖	
16	Alarm-In 16			NC	⊕, ⊖	

⏪ Save Cancel

Figure 19: Event – Alarm-In setup screen.

The alarm terminal strip on the back of the DVR has inputs associated with each alarm. You can set up each input on the Alarm-In screen. You can turn each input On or Off by highlighting the alarm number and pressing the  button.

Each input can be given a title. Highlight the desired Title box and press the  button. A virtual keyboard appears allowing you to enter a title name.

Each input can be set as NO (normally open) or NC (normally closed).

Highlight the box under the Actions and press the  button. You can set the actions the DVR will take whenever it senses an input on one of its alarm input connectors. Alarm input can be associated with cameras, trigger an Alarm-Out connector, sound the DVR's internal buzzer, notify a number of different devices, and/or move PTZ cameras to preset positions.

## Video Loss

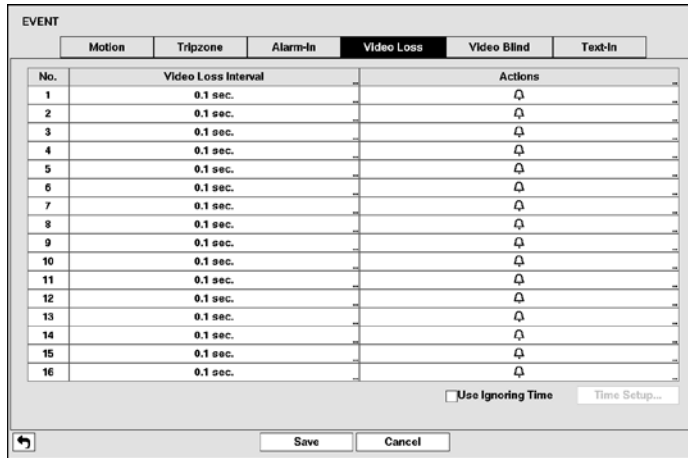

Figure 20: Event – Video Loss setup screen.

Highlighting the box under the Video Loss Interval heading allows you to set the duration of a signal loss before the DVR will report a Video Loss. The DVR will not consider any signal loss from a camera to be a Video Loss if the detected signal loss is shorter than the interval set on this screen.

Highlight the box under the Actions and press the button. The DVR can be set to react to video loss differently for each camera. Each camera can be associated with another camera, trigger an Alarm-Out connector, sound the DVR's internal buzzer, notify a number of different devices, and/or move PTZ cameras to preset positions.

Highlight Use Ignoring Time and press the button to toggle between On and Off. When set to On, the DVR will ignore video loss events occurring during the preset period. Highlighting Time Setup and pressing the button allows you to set up event ignoring time.

## Video Blind

EVENT

	Motion	Tripzone	Alarm-In	Video Loss	Video Blind	Text-In
No.	Sensitivity	Activation Time	Actions			
1	1/1	5 sec.	△			
2	1/1	5 sec.	△			
3	1/1	5 sec.	△			
4	1/1	5 sec.	△			
5	1/1	5 sec.	△			
6	1/1	5 sec.	△			
7	1/1	5 sec.	△			
8	1/1	5 sec.	△			
9	1/1	5 sec.	△			
10	1/1	5 sec.	△			
11	1/1	5 sec.	△			
12	1/1	5 sec.	△			
13	1/1	5 sec.	△			
14	1/1	5 sec.	△			
15	1/1	5 sec.	△			
16	1/1	5 sec.	△			

Use Ignoring Time    Time Setup...

Save    Cancel

Figure 21: Event – Video Blind setup screen.



The DVR checks to see if anything is blinding a camera.

Highlighting the box under the **Sensitivity** heading allows you to adjust the DVR's sensitivity to video blind for Black and White independently from 0 (Never) and 1 (least sensitive) to 15 (most sensitive).

**NOTE: Video blind might NOT be detected for a camera with a very noisy image especially when set for low sensitivity values.**

Highlighting the box under the **Activation Time** heading allows you to set the duration before the DVR will report a Video Blind. The DVR will not consider any blinded camera to be a Video Blind if the detected blindness is less than the Activation Time set on this screen.

Highlight the box under the **ACTIONS** and press the  button. The DVR can be set to react to video blind differently for each camera. Each camera can be associated with another camera, trigger an Alarm-Out connector, sound the DVR's internal buzzer, notify a number of different devices, and/or move PTZ cameras to preset positions.

Highlight **Use Ignoring Time** and press the  button to toggle between On and Off. When set to On, the DVR will ignore video blind events occurred during the preset period. Highlighting **Time Setup** and press the  button allows you to set up event ignoring time.

## Text-In

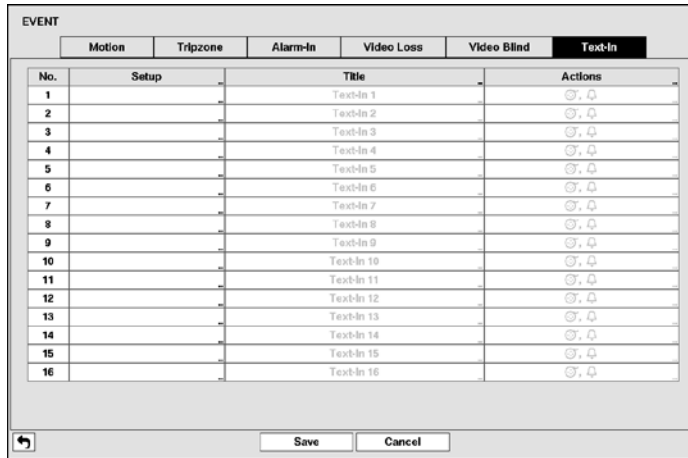
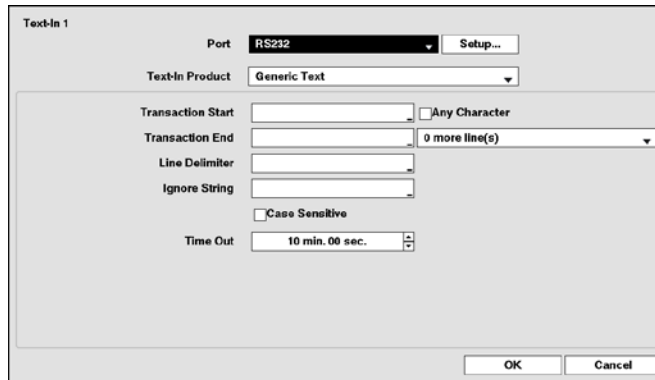

Figure 22: Event – Text-In setup screen.

The DVR can be set to react to text input from devices such as ATMs (Automated Teller Machines) and POS (Point of Sale; i.e., cash registers). This screen allows you to configure the DVR for each text-in device.

Highlight the box under the Setup heading, and press the button. Selecting the Setup heading changes all the parameters excluding Port settings of all the text input channels.

**NOTE:** The system performance might be affected when a large quantity of text inputs are detected from several channels at the same time.



Highlight the box beside Port, and press the button. Select from None, RS232, RS485, USB-Serial (1~8) and LAN (1~16).

**NOTE:** If you have set the Port as None, you will not be able to make any changes to the screen.

When using the USB to serial text-in device, do NOT remove the USB cable from the port while the system is running.

Text-in data might be lost when the text-in buffer is filled by simultaneous text-in transactions from all 16 LAN channels.

Highlight Setup..., and press the button. Use the ATM or POS manufacturer's recommended settings when configuring the RS232, RS485, USB-Serial or LAN ports.

Highlight the box beside Text-In Product, and press the button. Select your device from the list.

**NOTE: The following description is for a Generic Text Device. The screen changes for different types of text input devices, and there will be different parameter boxes for you to enter information.**

Highlight the box beside **Transaction Start**, and press the  button. Use the virtual keyboard to enter the Transaction Start string. Refer to the device manufacturer's documentation for the text string that the device first sends when a transaction starts.

If you want the DVR to react to any character sent from the text input device, you will want to turn **On Any Character**. Highlight **Any Character**, and press the  button to toggle between On and Off.

**NOTE: If Any Character is turned On, you will not be able to enter any text in the Transaction Start box.**

Highlight the box beside **Transaction End**, and press the  button. Use the virtual keyboard to enter the Transaction End string. Refer to the device manufacturer's documentation for the text string that the device sends when a transaction ends.

Highlight the **more line(s)** box, and press the  button. Select the number of additional lines of text that you want the DVR to record. You can choose from 0 to 10.

Highlight the box beside **Line Delimiter**, and press the  button. Use the virtual keyboard to enter the character(s) that the device uses to indicate the end of a line. Special characters can be created using ^ and a capital letter; e.g., ^J for NL (New Line), ^M for CR (Carriage Return). Refer to the device manufacturer's documentation for Line Delimiter character(s).

Highlight the box beside **Ignore String**, and press the  button. Use the virtual keyboard to enter any strings of text that you want the DVR to ignore. Refer to the device manufacturer's documentation for text strings that the device sends during transactions, so you will know which ones you do not want recorded.

Highlight the **Case Sensitive** box, and press the  button to toggle between On and Off. Refer to the device manufacturer's documentation to determine if the text strings are Case Sensitive. If the device distinguishes between upper and lower case letters, make certain the **Case Sensitive** box is turned On.

Highlight the box beside **Time Out**, and press the  button. Set the length of time to wait for the new text string. The DVR will consider a transaction complete if no new text strings are entered between the last text input and the dwell time out. You can adjust the Time Out dwell from 5 seconds to 15 minutes.

Each input can be given a title. Highlight the desired **Title** box and press the  button. A virtual keyboard appears allowing you to enter a title name.

Highlight the box under the **Actions** and press the  button. The DVR can be set to react to text input. Text input can be associated with cameras, trigger an Alarm-Out connector, sound the DVR's internal buzzer, notify a number of different devices, and/or move PTZ cameras to preset positions.

## Camera Setup

### General

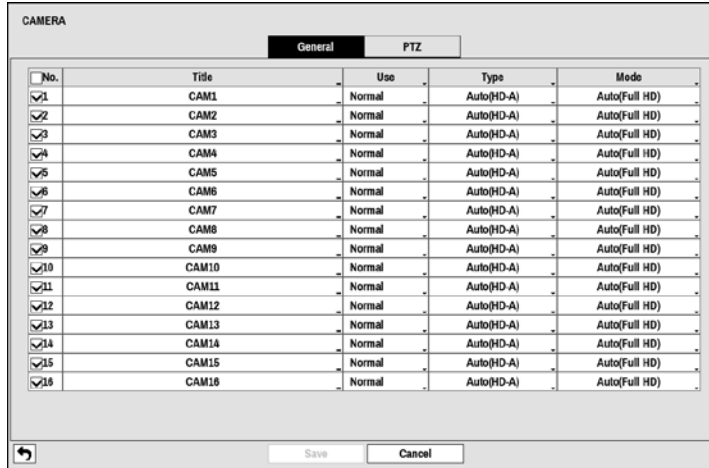

Figure 23: Camera – General setup screen.

You can turn the camera number On or Off, and you can change the Title of each camera using the virtual keyboard. You can also determine which cameras will display on the monitors by selecting Normal, Covert 1 or Covert 2 from a drop-down list in the Use column.

**NOTE:** When selecting the *Covert 1*, the DVR displays the camera title and status icons on the covert video. When selecting the *Covert 2*, the DVR displays only camera title on the covert video.

**A user who does not have Covert Camera View authority cannot view video from cameras set to Covert 1 or Covert 2 in both the live monitoring and playback modes.**

You can select the type supported by the camera among Auto, SD, HD-TVI and HD-A by highlighting the box under the Type heading and pressing the  button. Selecting Auto allows the DVR to automatically detect the type supported by the camera.

You can select the width resolution supported by the camera between Auto, 720, 960, HD and Full HD by highlighting the box under the Mode heading and pressing the  button. The input resolution is applied without rebooting the system. Selecting Selecting Auto allows the DVR to automatically detect the width resolution supported by the camera.

**NOTE:** The system restarts automatically after changing the resolution settings.

**If the camera's width resolution is 960 and Mode is set to Auto, 720 mode will be applied.**

**When you change the mode, the system restarts automatically.**



## PTZ

No.	Product	ID	Maximum Preset	Mode
1	None	0	16	None
2	None	0	16	None
3	None	0	16	None
4	None	0	16	None
5	None	0	16	None
6	None	0	16	None
7	None	0	16	None
8	None	0	16	None
9	None	0	16	None
10	None	0	16	None
11	None	0	16	None
12	None	0	16	None
13	None	0	16	None
14	None	0	16	None
15	None	0	16	None
16	None	0	16	None

Port: None Setup...

Save Cancel

Figure 24: Camera – PTZ setup screen.

**NOTE:** You will only be able to set up PTZ devices if the PTZ port is set to RS232 or RS485.

<None>

- AUTODOME (BOSCH)
- C-CC501 (TOA)
- CDC 2500 (Costar)
- CDC2100 (DynaColor)
- CRD-J641G (Chilsung)
- CRR-1060s (Fins)
- CRX-1401 (ERAEESEEDS)
- D-protocol (Pelco)
- Dennard2060 (Dennard)
- DMP-1253 (Tokina)
- DRX-600 (Dongyang UnitTech)
- DY-255RXC (Dongyang)
- Della Dome II/Ultra IV (Sensormatic)
- Fastrax (HiTron)
- Fastrax2 (HiTron)
- Fastrax-IE (HiTron)
- G3 Basic AutoDome (Phillips)
- GRU1604A (LG Honeywell)
- HDC-685 (Honeywell)
- HSD-25X (LG Honeywell)
- HSDN-251 (Honeywell)

<RS232,RS485>

<None>

- C-protocol (Pelco)

Highlight the box in the Product column for the PTZ camera you wish to configure and press the button. A list of PTZ devices appears. Select your camera from the list and press the button. You will need to connect the camera to the RS232 or RS485 connector on the back of the DVR following the camera manufacturer's instructions.

<UTC>

You can assign IDs to each camera by highlighting the box under the ID heading and pressing the button. Change the number by highlighting it and using the Up and Down arrow buttons to increase and decrease the number. The PTZ ID number can be set from 0 to 256.

You can assign the maximum number of presets to each camera by highlighting the box under the Maximum Preset heading and pressing the button. Change the number by highlighting it and using the Up and Down arrow buttons to increase and decrease the number. The maximum preset number can be set from 0 to 256.

**NOTE:** Please check out the maximum number of presets that the camera supports. If the number you assigned exceeds the camera's and one of the exceeded presets operates, the camera may malfunction.

Highlight the Setup... box and press the button. The Port Setup window appears.

You can select None, UTC, RS232 or RS485 by highlighting the box under the Mode. UTC is only used for HD and Full HD cameras.

Port Setup - RS232

Baud Rate: 9600

Data Bit: 8

Stop Bit: 1

Parity: None

OK Cancel

Configure the port's setting based on the PTZ camera manufacturer's instructions.

## Device Setup

### Audio

DEVICE

Audio Alarm-Out Remote Control

No.	Associated Camera
1	None
2	None
3	None
4	None

Enable Audio-Out

Save Cancel

Figure 25: Device – Audio setup screen.

The DVR can record up to four audio inputs. Highlight the box beside the input and press the  button. A list of cameras appears, and you can select which camera you want associated with that audio input.

Highlight Enable Audio-Out and press the  button. This toggles between enabling and disabling audio out.

## Alarm-Out

Figure 26: Device – Alarm-Out setup screen.

Highlighting the box beside **Dwell Time** and pressing the button allows you to set the dwell time of the alarm output. Dwell times range from 5 seconds to 30 minutes.

Each alarm output can be given its own title by highlighting **Title...** and pressing the button. A virtual keyboard appears allowing you to enter the title.

No.	Title	Reverse Relay
1	Alarm Out 1	<input type="checkbox"/>
2	Alarm Out 2	<input type="checkbox"/>
3	Alarm Out 3	<input type="checkbox"/>
4	Alarm Out 4	<input type="checkbox"/>

Check the **Reverse Relay** box to reverse the Alarm Output Type connected to the DVR rear panel (NO→NC).

You can add and edit alarm output schedules on this screen. Highlight the **+** and press the button to add a schedule. Highlighting the boxes under the **Column** heading and pressing the button allows you to edit the information in those boxes.

The **Day** box allows you to select the days that the alarm schedule will be active. The choices are: Sun, Mon, Tue, Wed, Thu, Fri, Sat, M~F, Hol and All.

The **Range** box allows you to set the time that the alarm schedule will be active in 15-minute increments from 00:00 to 24:00.

The **Mode** box allows you to set how the alarm reacts during the scheduled time. When set to **On**, the Alarm-Out is active during the scheduled time. When set to **Event**, the Alarm-Out is only active when there is an Event during the scheduled time.

The **Channels** box allows you to set which alarm outputs will be active. You can also select the DVR's internal buzzer.

The **X** box allows you to delete an alarm output schedule. You will be asked to confirm whether or not you really wish to delete the schedule.

## Remote Control



Figure 27: Device – Remote Control setup screen.

Highlight the box beside **Port** and select from None, RS232 and RS485. If the RS232 port and RS485 port are in use for PTZ control, networking or text input, the remote keyboard cannot be configured.

Highlight **Setup...** and select the correct Baud Rate, Parity, Data Bits and Stop Bits for the device you are connecting to the DVR.

Highlight the box beside **Remote Control Product** and select the device from the list.

## Network Setup

### General

NETWORK

General LAN FEN RTSP WebGuard VNC NetFS

Remote Watch

Multi Stream

	ips	Quality	Resolution
First Stream	30.00 ips	Standard	Standard
Second Stream	30.00 ips	Standard	Standard

bps/ips (ips)

Network Bandwidth Limit 1 Gbps

Remote Audio Channel Select From RAS

Enable SSL for Transferring Data

Save Cancel

Figure 28: Network – General setup screen.

Highlight Multi Stream and press the  button to toggle between On and Off. When it is On, the DVR supports more than one stream. You can configure to use a different stream depending on the layout mode or channel in a remote program.

Highlight the box under the ips heading and press the  button. You can select the Transfer Speed. The available value differs depending on the quality and resolution settings.

Highlight the box under the Quality heading and press the  button. You can select the Quality from: Very High, High, Standard and Basic. Press the  button to set the Quality.

Highlight the box under the Resolution heading and press the  button. You can select the Resolution from: Very High, High and Standard. Press the  button to set the Resolution.

**NOTE: During playing, the transfer speed can be low.**

**The higher Quality and Resolution settings require higher Transfer Speed settings. The transfer speed you set is the maximum speed. Depending on the network environment, this speed may not be achieved.**

Highlight the box beside bps/ips. You can select the unit of measure for the transfer speed between: bps and ips.

You can limit the network bandwidth settings so that the system does not consume too much network bandwidth. Highlight the box beside Network Bandwidth Limit and press the Up and Down arrow buttons to set the desired maximum bandwidth.

**NOTE: When limiting the network bandwidth, the remote watch image on the PC running RAS or WebGuard might not be displayed properly.**

The DVR supports two-way audio communication between a local system and a PC running RAS. Highlighting the box beside Remote Audio Channel and pressing the  button allows you to select the audio channel that sends audio to the remote site. Selecting Select From RAS will send audio of the channel selected from RAS.

**NOTE: Depending on network conditions, audio might be interrupted or out of synchronization during transmission.**

Highlight Enable SSL for Transferring Data and press the  button to toggle between On and Off. When it is On, the security of data except video and audio transmitted for remote monitoring or remote recording can be enhanced by using the SSL (Secure Sockets Layer) authentication. When using the SSL function, the DVR cannot be connected with a remote program or a network keyboard which does not support the SSL function.

**CAUTION:** The remote connection will be disconnected temporarily after changing the SSL settings.

**NOTE:** While the SSL function is enabled, the network transfer speed you selected may not be achieved.

This product includes software developed by the OpenSSL Project for use in the OpenSSL Toolkit (<http://www.openssl.org/>).

## LAN

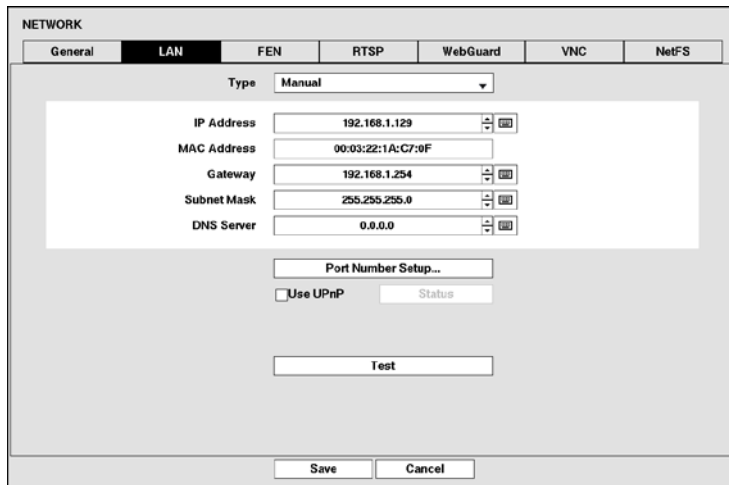



Figure 29: Network – LAN setup screen.

Highlight the box beside Type and press the  button. You can select the type of network configuration from: Manual or DHCP. Select the desired type and press the  button.

Selecting Manual from the Type allows you to set up LAN parameters manually.

Change the numbers by highlighting them and using the Up and Down arrow buttons to increase or decrease the number. The factory default LAN settings are:

IP Address: 192.168.1.129  
 Gateway: 192.168.1.254  
 Subnet Mask: 255.255.255.0

**NOTE:** You will need to get the appropriate IP Address, Gateway and Subnet Mask from your network administrator.

Highlight the box beside DNS Server. Press the Up and Down arrow buttons to set the IP address of the DNS server.

Highlight the Port Number Setup... box and press the  button. The Port Number Setup screen appears.

**NOTE:** You will need to get the appropriate Port Numbers for each RAS and WebGuard related program (Admin, Callback, Watch and Search) from your network administrator.

Port Number Setup (8000 - 12000)

Remote Admin: 8200

Remote Callback: 8201

Remote Watch: 8016

Remote Search: 10019

OK Cancel

Change the numbers by highlighting them and using the Up and Down arrow buttons to increase or decrease the number. The factory default Port settings are:

Remote Admin: 8200  
 Remote Callback: 8201  
 Remote Watch: 8016  
 Remote Search: 10019

**NOTE:** The system restarts automatically after changing the port settings.

Do NOT use the same port number for two different programs, otherwise, the DVR cannot be connected with the PC running RAS or WebGuard.

**CAUTION:** When changing the port settings, you must change the port settings on the PC running RAS as well. Refer to the RAS manual for details.

Highlight Use UPnP and press the  button to toggle between On and Off. When it is On, port forwarding from the NAT (Network Address Translation) device to the DVR will be enabled automatically via UPnP (Universal Plug and Play) service. This function will be especially useful when accessing a port on a private IP address.

**NOTE:** For the UPnP service to work, the NAT device should support the UPnP Port Forwarding function and the function should be set to enabled.

You cannot change the port settings when Use UPnP is On.

Highlight the Status box and press the  button to display the port numbers forwarded from the NAT device via UPnP service.

Highlight the Test box and press the  button to test the current LAN settings you made.

NETWORK

General LAN FEM RTSP WebGuard VNC NetS

Type: DHCP

IP Address: 0.0.0.0

MAC Address: 00:09:32:1A:C7:9F

Gateway: 0.0.0.0

Subnet Mask: 0.0.0.0

DNS Server: 0.0.0.0  Auto

Port Number Setup...

Use UPnP

Save Cancel

Selecting DHCP from the Type and highlighting Save button reads the current IP address of the DVR configured by DHCP (Dynamic Host Configuration Protocol) network.

Highlight Auto (Default) and press the  button to toggle between On and Off. When it is On, the DVR will obtain the IP address of the DNS server automatically.

**NOTE:** Selecting Auto will only be enabled when the DVR is configured for DHCP network.

**NOTE:** If the DVR is configured for DHCP network, the IP address of the DVR might change whenever the unit is turned on.

## FEN

NETWORK

General LAN **FEN** RTSP WebGuard VNC NetFS

Use FEN

FEN Server dvmames.net

Port 10088 (10000 - 12000)

FEN Name Check

Status Not Connected

Save Cancel

Figure 30: Network – FEN setup screen.

Highlight Use FEN and press the  button to toggle between On and Off.

**NOTE: FEN is the technology that automatically sets up your DVR to work seamlessly for remote viewing via your network internet connection. For FEN to work, naming your DVR will be required.**

Highlight the box beside FEN Server and press the  button. A virtual keyboard appears allowing you to enter the IP address or domain name of the FEN server.

**NOTE: You will need to get the IP Address or domain name of the FEN Server from your network administrator. You can use the domain name instead of IP address if you already set up the DNS Server when setting up the LAN.**

Highlight the box beside Port and press the  button. Set the port number of the FEN server using the Up and Down arrow buttons to increase or decrease the numbers.

Highlight the box beside FEN Name and press the  button. A virtual keyboard appears allowing you to enter the DVR name to be registered on the FEN server.

Highlight the Check box and press the  button to check whether or not the name you entered can be used.

**NOTE: The FEN Name you entered should be checked by selecting Check, otherwise the FEN changes will not be saved.**

**When entering no name or a name already registered on the FEN server, an error message displays.**

The box beside Status displays the current information of the Rendezvous server and NAT (Network Address Translation) device.



## RTSP

The screenshot shows the 'NETWORK' configuration page with the 'RTSP' tab selected. The 'Enable RTSP' checkbox is currently unchecked. Below it, the 'RTSP Port' is set to 554. The 'RTP Port' section contains 'RTP Start Port' set to 16001 and 'RTP End Port' set to 17000. The 'Use Mobile' checkbox is also unchecked. At the bottom, there are 'Save' and 'Cancel' buttons.

Figure 31: Network – RTSP setup screen.

Highlight **Enable RTSP** (Real-Time Streaming Protocol) and press the button to toggle between On and Off. You will be able to change the settings if **Enable RTSP** is enabled.

Highlight the box beside **RTSP Port** and press the button. Set the port number of the RTSP server obtained from your system administrator.

Highlight the box beside **RTP Start Port** and press the button. Set the start port number of the RTP server obtained from your system administrator.

Highlight the box beside **RTP End Port** and press the button. Set the end port number of the RTP server obtained from your system administrator.

Highlight **Use Mobile** and press the button to toggle between On and Off. When set to on, you can access a remote DVR using a Blackberry or other mobile devices.

**NOTE:** Selecting *Use Mobile* sets the **WebGuard** service to be enabled automatically regardless of your **WebGuard** settings.

**When using NAT (Network Address Translation) or firewall services, opening all UDP ports allows you to access a DVR using Blackberry and Android devices.**

**You can access a remote DVR and monitor live video images using media players, such as VLC Player, supporting RTSP service. Start the media player on your local PC and enter "rtsp://ID:Password@IP address:RTSP port number/trackID='channel number'", or start Internet Explorer on your Blackberry or other mobile devices and enter "http://IP address:Webguard port number/".**

**Some media players might play video properly depending on network conditions.**

**RTSP service might not be supported, depending on the type of media player.**

## WebGuard



Figure 32: Network – WebGuard setup screen.

Highlight Use WebGuard Service and press the  button to toggle between On and Off. See *Appendix – WebGuard* for detailed descriptions of the WebGuard service.

Highlight the box beside PORT and press the  button. Set the port number used when accessing WebGuard by using the Up and Down arrow buttons to increase or decrease the numbers.

## VNC



Figure 33: Network – VNC setup screen.

Highlight Use VNC (Virtual Network Computing) and press the  button to toggle between On and Off. You will be able to change the settings if Use VNC is enabled.



**NOTE:** VNC service allows you to access the DVR and control it remotely using a PC or mobile devices via Ethernet.

Highlight the box beside PORT and press the  button. Set the port number of the VNC server obtained from your system administrator.

Highlight the box beside Password and press the  button. A virtual keyboard appears allowing you to enter the password for VNC connection.





**NOTE: Up to three users at a time can access a DVR remotely via VNC service.**

**When controlling the DVR remotely using a keyboard, shortcut keys perform the following functions as described below:**

Key	Function
“←” or “h”	Pressing the “←” or “h” key moves to the left in the menu. It is the same as pressing the Left arrow button on the front panel.
“→” or “i”	Pressing the “→” or “i” key moves to the right in the menu. It is the same as pressing the Right arrow buttons on the front panel.
“↑” or “k”	Pressing the “↑” or “k” key moves up in the menu. It is the same as pressing the Up arrow button on the front panel.
“↓” or “j”	Pressing the “↓” or “j” key moves down in the menu. It is the same as pressing the Down arrow button on the front panel.
“m” or  (Windows)	Pressing the “m” or  key displays the Live Monitoring menu or Search menu on the screen. It is the same as pressing the <b>MENU</b> button on the front panel.
“Enter” or “Return”	Pressing the “Enter” or “Return” key selects the highlighted item or completes an entry that you have made during system setup. It is the same as pressing the  (Enter) button on the front panel.
“d” or “PageUp” or “PageDown”	Pressing the “d” or “PageUp” or “PageDown” key toggles between different display formats. It is the same as pressing the <b>DISPLAY</b> button on the front panel.
“c” or “Home”	Pressing the “c” or “Home” key allows you to copy video clips. It is the same as pressing and holding the <b>MENU</b> button on the front panel for three seconds or longer while the Search mode.
“F5”	Pressing the “F5” key refreshes the current VNC screen.

## NetFS

It allows you to register NetFS sites for the following functions:

- Upload or download of files for upgrade, import/export of a setup file, log export, or file print on an FTP site or from an FTP site. Related settings are as follows:
  -  (Setup) in the live monitoring mode > System menu > General tab > Upgrade, Import, Export, or System Log – Export setting,
  -  (Export) in the search mode > Print
- Upload of clip-copy files on a FTP site. Related settings are as follows:
  -  (Export) in the search mode > A-B Clip-Copy or Clip-Copy.
- FTP notification of an event detection (system event excluded). Related settings are as follows:
  -  (Setup) in the live monitoring mode > Notification menu > FTP tab > FTP setting,
  -  (Setup) in the live monitoring mode > Event menu > Actions – Notify (FTP) setting).

**NOTE: FileZilla and smallFtp servers are currently supported.**

**This feature is supported only in the passive mode of an FTP site.**

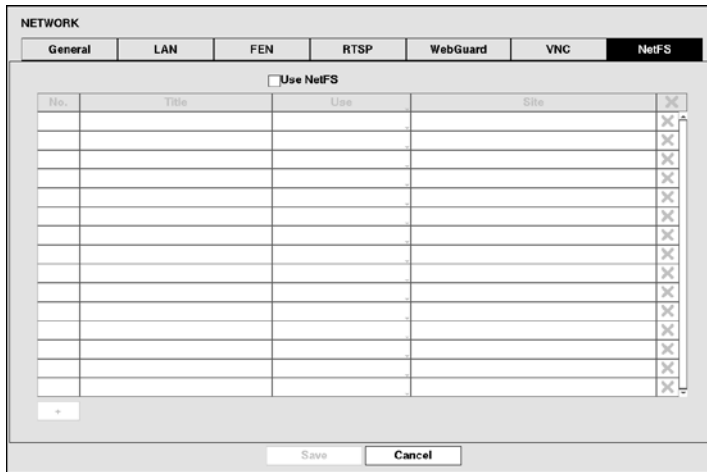

Figure 34: Network – NetFS.

Highlight Use NetFS and press the  button to toggle between On and Off.

The Title box displays the NetFS site name. Use the virtual keyboard to enter the name.

The Use box allows you to select the usage of the NetFS function.

- N/A – It disables the NetFS function.
- ALL – It enables all NetFS functions.
- Upgrade – It allows you to use the upgrade file uploaded on the NetFS site.
- Setup – It allows you to import or export a setup file uploaded on the NetFS site.
- System Log – It allows you to save system log on the NetFS site.
- Clip-Copy – It allows you to manually copy video clips to the NetFS site or to automatically copy event-detected video clips to the NetFS site.
- Print – It allows you to save images as a PDF file on the NetFS site.

The Site box displays the NetFS site information.

The  box allows you to delete a NetFS site.

**NOTE:** When you delete an FTP site in the *NetFS* setup screen on the *Network* menu, the FTP site in the *FTP* setup screen on the *Notification* menu will be deleted, too.

**When you change the usage to other than ALL or Clip-Copy, an FTP notification function will be disabled.**

Highlight the + and press the  button to register a NetFS site (max. 16).

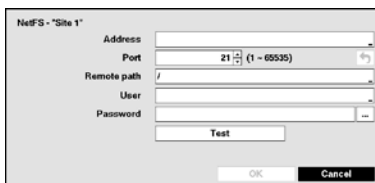

Highlight the box beside Address and press the  button. A virtual keyboard appears allowing you to enter the NetFS address.

Highlight the box beside PORT and press the  button. Set the port number used when accessing the NetFS site by using the Up and Down arrow buttons to increase or decrease the numbers.

Highlight the box beside Remote path and press the  button. A virtual keyboard appears allowing you to enter a folder path in the NetFS site.

Highlight the box beside User and Password and press the  button. A virtual keyboard appears allowing you to enter the user and password used when accessing the NetFS site.

Highlight the Test box and press the  button to test the current NetFS site settings you made.

## Notification Setup

### Callback

No.	IP Address	
<input type="checkbox"/> 1	0.0.0.0	-
<input type="checkbox"/> 2	0.0.0.0	-
<input type="checkbox"/> 3	0.0.0.0	-
<input type="checkbox"/> 4	0.0.0.0	-
<input type="checkbox"/> 5	0.0.0.0	-

Retry: 5

Figure 35: Notification – Callback setup screen.

The DVR can be set up to contact a computer running RAS (Remote Administration System) when an event occurs. Highlight the box under the No. heading and press the  button to toggle between On and Off. You will only be able to change the IP addresses if No. is enabled.

Highlight the IP Address box that you want to change and press the  button. Use the arrow buttons to enter the IP address of the computer you want contacted during an event. You can enter up to five IP addresses.



Highlight the box beside Retry and enter the number of times you would like the DVR to try contacting the computer. You can select from 1 to 10 retries.

### Mail

Group & Recipient	Attach Type
<input type="checkbox"/> default group	None
<input type="checkbox"/>	
<input type="checkbox"/>	
<input type="checkbox"/>	
<input type="checkbox"/>	
<input type="checkbox"/>	
<input type="checkbox"/>	
<input type="checkbox"/>	
<input type="checkbox"/>	
<input type="checkbox"/>	
<input type="checkbox"/>	
<input type="checkbox"/>	
<input type="checkbox"/>	

+ Group   + Mail   SMTP Setup

Figure 36: Notification – Mail setup screen.

The DVR can be set up to send an email when an event occurs. The Mail Group and Recipient can be turned On or Off by highlighting the boxes beside the individual mail group and recipient accounts and pressing the  button. Highlighting the box beside “Group & Recipient” and pressing the  button will toggle between all mail accounts being turned On and Off.

The +/- column is used to collapse and expand recipient groups. If there is a + or – in this column, it indicates the item is a Group Name. If there is a – in front of the Group Name, it indicates that the group has been “expanded” and all of the Recipient Names within that group are displayed below the Group Name. If there is a + in front of the Group Name, it indicates that the group has been “collapsed” and all of the Recipient Names within that group are hidden. To collapse or expand a group, highlight the +/- column in front of the desired group and press the  button.

The ✕ column can be used to delete a Recipient Name or an entire Group. If the ✕ is grayed out, that Group or Recipient cannot be deleted. Highlight the ✕ and press the  button. You will be asked to confirm that you want to delete the Recipient or Group.

Highlight the + Group and press the  button to add a recipient Group and select the image file format attached to an email.

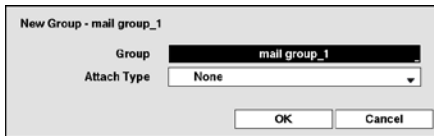



Highlight the box beside Group and press the  button. A virtual keyboard appears allowing you to enter the Group name.

Highlight the box beside Attach Type and press the  button. You can select between CBF, JPG and MP4. When selecting CBF, the DVR will attach an event detected video clip to an email. When selecting JPG, the DVR will attach the event detected image file (JPEG format) to an email. When selecting MP4, the DVR will attach the event detected video clip (MP4 format) to an email.

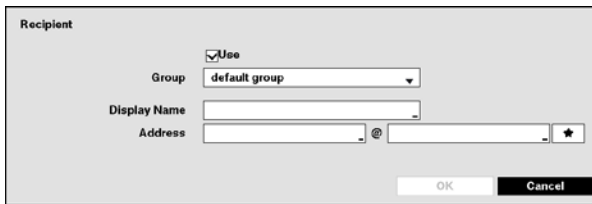
Highlight the + Mail and press the  button to add a mail Recipient.



Highlight Use and press the  button to toggle between On and Off. Assign the Recipient to a Group and enter the Recipient’s Display Name.

Highlight the box beside Address and enter the recipient’s e-mail address and mail server provider. Highlighting  allows you to select the mail server provider from a list of registered SMTP mail server providers.

Highlight the box under the Attach Type heading and press the  button to change the image file format attached to an email.

**NOTE: Attaching a image file to an email will not be available for the Text-In event.**

Highlight SMTP Setup... and press the  button. The SMTP Setup screen appears.

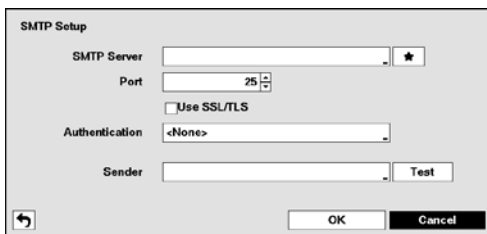

Highlight the box beside SMTP Server and press the  button. A virtual keyboard appears that you can use to enter the IP address or domain name of the SMTP server. Highlighting  allows you to select your SMTP server from a list of registered SMTP servers.

**NOTE: You will need to get the IP Address or domain name of the SMTP Server from your network administrator.**

**NOTE: You can use the domain name instead of IP address if you already set up the DNS Server when setting up the LAN.**

Highlight the box beside Port and press the  button. Use the arrow buttons to enter the SMTP Server port number obtained from your system administrator. The default port number is 25.

Highlight Use SSL/TLS and press the  button to toggle between On and Off. When it is On, the DVR can send an email via an SMTP server requiring SSL (Secure Sockets Layer) authentication.

**NOTE:** This product includes software developed by the OpenSSL Project for use in the OpenSSL Toolkit (<http://www.openssl.org/>).

Highlight the box beside Authentication and press the  button. An Authentication screen appears. Highlight Use and press the  button to toggle between On and Off. Highlight the box beside User/Password and press the  button. A virtual keyboard appears allowing you to enter the user ID and password.

Highlight the box beside Sender and enter the sender's e-mail address. Use the virtual keyboard to enter the e-mail address.

Highlight the box beside Display Name and enter the Sender's Display Name. Highlight the box beside Address and enter the sender's e-mail address and mail server provider. Highlighting allows you to select the mail server provider from a list of registered mail server providers.

Highlight the Test box and press the  button to test emailing with the current settings you made.

## SNS

Figure 37: Notification – SNS setup screen.

The DVR can be set up to post a message via SNS (Social Network Service) when an event occurs. You can add and edit the SNS account on this screen. The SNS account can be turned On or Off by highlighting the boxes under the No. heading and pressing the  button.

To add an SNS account, highlight the + and press the  button. Highlight the box beside Type and press the  button. Selecting Twitter from the Type allows you to post a tweet on Twitter when an event occurs.

Highlight the box beside User Name/Password and press the  button. A virtual keyboard appears allowing you to enter the user name and password.

The SNS accounts can be deleted by highlighting the beside the account and pressing the  button.

**NOTE:** Posting a tweet might fail because of Twitter limitations.

**FTP**

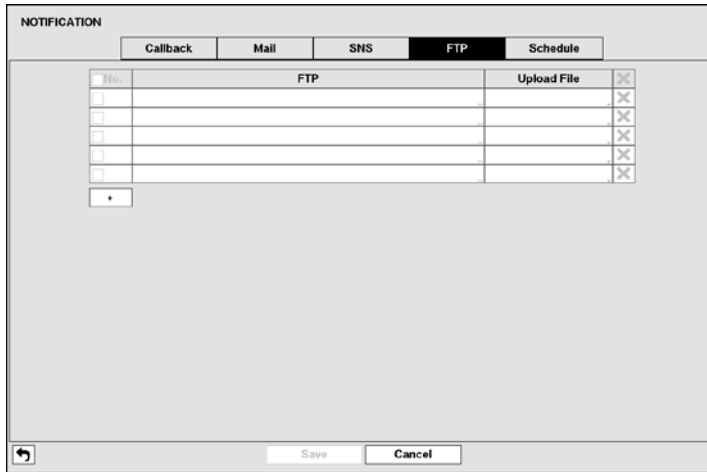

Figure 38: Notification – FTP setup screen.

The DVR can be set up to upload event detected image or video clip on an FTP site when an event occurs.

The FTP box displays the FTP site information.

The Upload File box displays the file format to be uploaded on the FTP site.

Highlight the + and press the  button to register a FTP site (max. 5).



Highlight the box beside Site and press the  button. A list of the registered FTP sites is displayed. Select an FTP site from the list. If the Use setting of the NetFS site is set to other than ALL or Clip-Copy, you cannot select the FTP site. You can change the Use setting or register other FTP sites in the NetFS setup screen on the Network menu.

Highlight the box beside Upload File and press the  button. You can select between CBF, JPG, and MP4. When selecting CBF, the DVR will upload an event detected video clip on the FTP site. When selecting JPG, the DVR will attach the event detected image file (JPEG format) on the FTP site. When selecting MP4, the DVR will attach the event detected video clip (MP4 format) on the FTP site.

The Site Info box displays the FTP site information.

**NOTE:** For the FTP notification to work properly, the related settings should be configured:

- Network menu > NetFS tab > Use setting
- Event menu > Actions – Notify (FTP) setting

When you delete an FTP site in the NetFS setup screen on the Network menu, the FTP site in the FTP setup screen on the Notification menu will be deleted, too.

If many event occurs during a short period, images may not be uploaded on the FTP site.

The FTP notification is not supported for system events.

If upload fails several times, it deletes the images or video clips.

When the DVR boots, it deletes all images and video clips even if they were not uploaded yet.

JPG format files will be uploaded even when storage space is not enough.





## Display Setup

### OSD

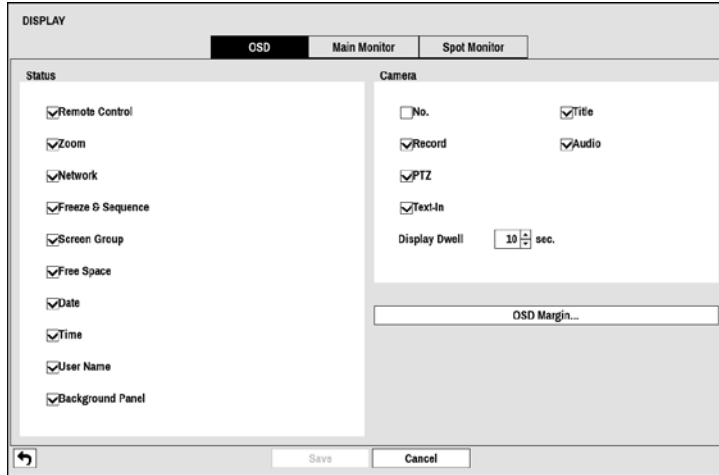











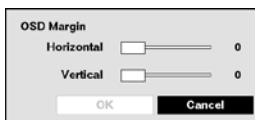



Figure 40: Display – OSD setup screen.

Highlighting an item and pressing the  button toggles that item On and Off. When an item is On, there is a checkmark in the box beside it. The following items can be turned On or Off:

- Remote Control – The icon  displays when the DVR can be controlled by the infrared remote control.
- Zoom – The icon  displays on the enlarged video.
- Network – The icon  displays when the unit is connected to a network via Ethernet. The icon  displays on each camera when audio communication is available between the DVR and a PC running RAS via Ethernet. The icon  displays when VNC service is running.
- Freeze & Sequence – The icon  displays while in the Freeze mode, and the icon  displays while in the Sequence mode.
- Screen Group – The number of screen group displays when the DVR is not in the 4x4 display mode of the 16-channel DVR and 3x3 mode of the 8-channel DVR.
- Free Space – The icon  displays when the DVR is in the Recycle mode, and the percentage of available storage space displays when the DVR is not in the Recycle mode.
- Date/Time – The current date and time information displays.
- User Name – The name of the current user logged in displays.
- Background Panel – The background panel at the bottom of the screen displays in black.
- Camera No. – The camera number displays at the top-left corner of each camera screen.
- Camera Title – The camera title displays at the top-left corner of each camera screen.
- Record – The record related icons display on each camera screen.
- Audio – The icon  displays on each camera screen for which the DVR can play live audio.
- PTZ – The icon  displays on each PTZ camera screen.
- Text-In – The text input strings display on the screen. You can adjust the Display Dwell time (sec.) for the text input strings displayed on the screen.

You can adjust the transparency of the setup screens by highlighting Transparency and using the Left and Right arrow buttons.



Highlighting OSD Margin... and pressing the  button displays how OSD text will be displayed on the monitor. You can adjust the horizontal and vertical margins so that text and icons will not be hidden beyond the edges of the monitor.

## Main Monitor



Figure 41: Display – Main Monitor setup screen.

Highlight the box beside **Mode** and press the  button. You can select between Full Sequence and Cameo Sequence.

Pressing the **SEQUENCE** button causes the DVR to sequence cameras, and the DVR can sequence cameras in two modes: “Full” and “Cameo”. In the Full mode, the DVR sequences through the cameras and displays them full screen. In the Cameo mode, the bottom right window in a multi-screen format sequences through the cameras.

**NOTE: Any cameras that are Off, have lost video or are set to Covert (unless the user has authority to view covert cameras) will be excluded from the Cameo sequence.**

You can define the screen layout in a variety of formats and set the DVR to sequence through the different screen layouts (pages) so that all the cameras will be displayed. You can also set up the DVR to display one camera or a group of cameras all the time while cycling through the remaining cameras in a “cameo” window. This can be done with one camera displayed full screen while displaying the cameo window as a PIP (picture in picture), or displaying the cameras in a grid pattern with the bottom right window as the cameo.

**NOTE: Sequence cannot be used in the 4x4 display mode of the 16-channel and 4x3 mode of the 8-channel DVR.**

You can adjust the display dwell time by highlighting the box beside **Interval** and pressing the  button. You can select dwell intervals ranging from 1 second to 1 minute.

Highlight **Event Monitoring On** and press the  button. Pressing the  button toggles between On and Off. When it is On, the DVR will display the camera associated with the event when an event occurs.

Highlight the box beside **Resolution** and press the  button. You can select from 1280x1024, 1440x900, 1920x1080 and 3840x2160 for NTSC video, and 1280x1024, 1440x900, 1920x1080 and 3840x2160 (@ 60Hz or 50Hz) for PAL video.

**NOTE: When the individual main monitors are connected to the HDMI and VGA connectors for simultaneous operation, it is recommended to use monitors supported with the same resolution. If monitors unsupported with the same resolution are connected, video cannot be displayed on the monitor with the resolution you have set.**

Highlight **Set Resolution to Manual Mode** and press the  button. When it is On, the resolution will be set manually regardless of the resolution supported by the monitor.

Highlight **Fit To Screen** and press the  button. Pressing the  button toggles between On and Off. When it is On, the DVR will resize video to fit the main monitor screen.

## Spot Monitor

Highlight Spot Monitor and press the  button, and the Spot Monitor setup screen appears.

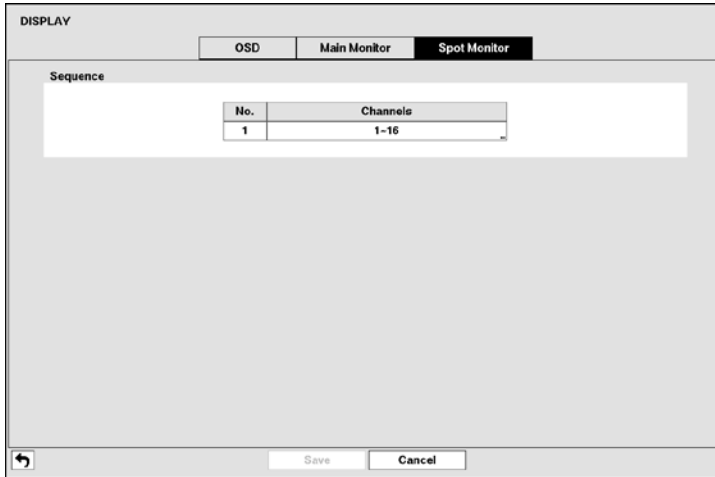
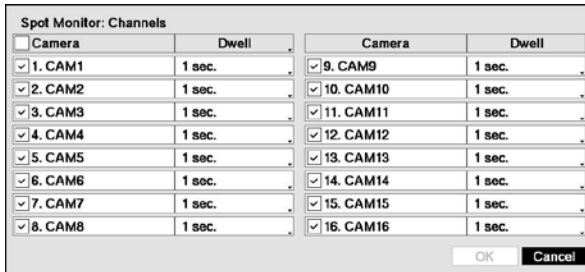





Figure 42: Display – Spot Monitor setup screen.

Highlight the box in the Channels column and press the  button.



You can define which cameras display sequentially on the Spot Monitor when in the single-screen display format. Highlighting the box under the Camera and pressing the  button toggles between On and Off.

You can adjust the display dwell time by highlighting the box under the Dwell and pressing the  button. You can select dwell intervals ranging from 1 to 20 seconds.

Pressing the **SEQUENCE** button on the remote control or selecting  (Sequence) in the Live Monitoring menu causes the DVR to sequence cameras.

**NOTE:** Sequence cannot be used in the 4x4 display mode of the 16-channel.

**Monitoring and playing back video from network devices is not supported on the SPOT monitor.**

## Chapter 4 — Operation

**NOTE:** This chapter assumes your DVR has been installed and configured. If it has not, please refer to Chapters 2 and 3.

The DVR's controls are similar to a VCR. As with a VCR, the main functions are recording and playing back video. However, you have much greater control over recording and playing back video. You can establish recording schedules based on time of day and day of the week. The DVR allows you to search through the recorded video using much more sophisticated tools than those available with VCRs. Additional DVR features that are not available with VCRs are remote control and viewing, and recording video at the same time you are watching previously recorded video.

The front panel controls are described in *Chapter 3 — Configuration*.

### Turning on the Power

Once you have installed the DVR following the instructions in *Chapter 2 — Installation*, it is ready to record.

### Live Monitoring

As soon as the DVR completes its initialization process, it will begin showing live video on the attached monitor and playing live audio through the attached speaker. The default mode is to display all cameras at once. Pressing any camera button will cause that camera to display full screen. It displays live video and plays live audio until the user enters another mode.

While in the live monitoring mode, pressing the **MENU** button displays the following Live Monitoring menu on the right edge of the screen. Pressing the **MENU** button again hides the menu. You can navigate through menus and items by pressing the arrow buttons.





Figure 43: Live Monitoring menu.

**NOTE:** The Live Monitoring menu also can be displayed by moving the mouse pointer on the right edge of the screen.

## Live Monitoring Menu









### Login/Logout

Selecting  (Login) in the Live Monitoring menu accesses the Login screen, and you will be asked to select a User and enter the password to log into the system. Selecting  (Logout) in the Live Monitoring menu displays the Logout screen asking you to confirm whether or not you want to log out the current user.

### Monitor

Selecting  (Monitor) in the Live Monitoring menu will allow you to select the monitor from Main and Spot. It is the same as pressing the **MONITOR** button. You can select the screen format and sequence monitoring of the selected monitor.



### Display

- **Full Screen:** Selecting  (Display) →  (Full Screen) and choosing the camera number button displays the selected camera full screen. It is the same as pressing the individual camera buttons on the front panel or clicking the left mouse button on a camera image when in one of the multiview formats (i.e., 2x2, 1+5, 1+7, 3x3 or 4x4). Clicking the left mouse button on the screen again returns to the previous display mode.
- **PIP, 2x2, 1+5, 1+7, 3x3, 4x4:** Selecting  (Display) → , , , ,  or  (PIP, 2x2, 1+5, 1+7, 3x3 or 4x4) displays the cameras in the selected multiview screen mode (PIP, 2x2, 1+5, 1+7, 3x3 or 4x4). Selecting each display mode is the same as pressing the **DISPLAY** button or scrolling the mouse wheel up and down when in one of the multiview formats (i.e., 2x2, 1+5, 1+7, 3x3 or 4x4).



**NOTE:** In the 1+5 or 1+7 display mode, the main channel indicates the channel displayed on the large screen which is displayed in the top-left. You can select the camera you want to display on the main channel screen. Select a channel on the screen and click the right mouse button to display the Camera Menu. Selecting *Go To Main* swaps the selected channel with the main channel. This function is supported only in the 1+5 and 1+7 display modes and can be activated from any of channel screens except the main channel screen.

- **Camera OSD, Status OSD:** Selecting  (Display) → Camera OSD or Status OSD toggles Camera OSD or Status OSD On and Off.

### Previous Group, Next Group

Selecting  or  (Previous Group or Next Group) in the Live Monitoring menu moves to the previous or next page. It is the same as pressing the **GROUP** button.



### Freeze

Selecting  (Freeze) in the Live Monitoring menu will freeze the current image on the screen until you select  again. It is the same as pressing the **Enter** button. Pressing any button except for the **MENU** and **PANIC** buttons while in the Freeze mode can also exit the Freeze mode. While in the Freeze mode, the icon  displays in bottom-left corner if Freeze is selected in the Display setup screen (OSD tab).



### Alarm

Selecting  (Alarm) in the Live Monitoring menu resets the DVR's outputs including the internal buzzer during an alarm.



### Panic

Selecting  (Panic) in the Live Monitoring menu starts panic recording of all cameras, and selecting  again stops panic recording. It is the same as pressing the **PANIC** button.

## Sequence

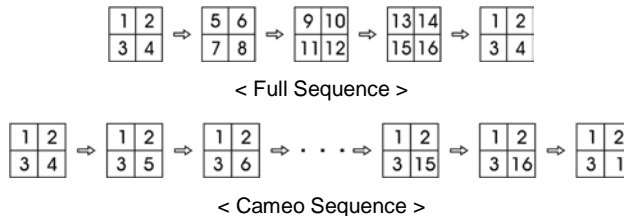





Selecting  (Sequence) in the Live Monitoring menu causes the cameras to display sequentially. It is the same as pressing and holding the **SEQUENCE** button for three seconds or longer. When in one of the multi-view formats, selecting  will cause the DVR to go through predefined screen layouts (Full Sequence). Or, the bottom, right screen will display live cameras sequentially (Cameo Sequence). For example, if you select  in the 2x2 format, the DVR changes pages as follows:



Selecting  again in the Live Monitoring menu exits the Sequence mode. While in the Sequence mode, the  icon displays in bottom-left corner if Sequence is selected in the Display setup screen (OSD tab). If all the cameras in a page are Off, or have lost video or are set to Covert (unless the user has authority to view covert cameras), that page will be excluded from the sequence.

**NOTE:** The *Full Sequence* for the full sequence monitoring and the *Cameo Sequence* for the cameo sequence monitoring should be selected in the Display setup screen (Main Monitor tab).

## Camera Menu



- **PTZ:** Selecting  (Camera Menu) → PTZ and choosing the camera number allows you to control the selected camera as long as it has Pan, Tilt and Zoom capabilities. It is the same as pressing the **PTZ** button. Refer to the following *PTZ Mode* section for details.
- **Zoom:** Selecting  (Camera Menu) → ZOOM and choosing the camera number zooms the current image of the selected camera on the screen. It is the same as pressing the **ZOOM** button. Selecting ZOOM again in the Camera Menu again exits the Zoom mode. Refer to the following *Zoom Mode* section for details.
- **Audio:** Selecting  (Camera Menu) → Audio toggles audio output On and Off.
- **Color Control:** Selecting  (Camera Menu) → Color Control and choosing the camera number allows you to control brightness, contrast, hue and saturation for each camera for the selected camera if a user who has Color Control authority logs into the system. It is the same as pressing and holding a camera button for a few seconds.
- **Menu Control:** Selecting  (Camera Menu) → Menu Control and choosing the camera number allows you to change camera settings supported in the camera. This is supported only when the camera uses Pelco-C protocol and supports the UTC (Up The Coax) function.
- **Edit Group:** Selecting  (Camera Menu) → Edit Group enters to the Active Cameo mode. It is the same as pressing and holding the **MENU** button for three seconds or longer in any multiview formats. Refer to the following *Active Cameo Mode* section for details.

**NOTE:** It is important that cameras and monitors are correctly installed and adjusted prior to making any image adjustments using the DVR's controls.

Any image adjustments you make will be applied to both the live video on the monitors and the recorded video.

The *Camera Menu* also can be displayed by clicking the right mouse button on the screen while in the live monitoring mode.

## Search

- **All Channels:** Selecting  (Search) → All Channels exits the live monitoring mode and enters the search mode. It is the same as pressing the **SEARCH** button.
- **Triplex:** Selecting  (Search) → Triplex enters the Triplex mode. Selecting the camera number plays back video of the selected camera. It is the same as pressing the **SEARCH** button when in one of the multiview formats.

## Setup

Selecting  (Setup) in the Live Monitoring menu enters the Main Setup screen. Refer to *Chapter 3 – Configuration* for detailed descriptions of system setup.

## Status

Selecting  (Status) in the Live Monitoring menu allows you to check the status of the DVR's system, inputs and storage. Refer to the following *Status Monitoring* section for details.

**NOTE:** Selecting *Status* will only be enabled for a user who has *System Check* authority.

## Active Cameo Mode

You can enter the Active Cameo mode by selecting **Edit Group** from the Live Monitoring – Camera menu or pressing and holding the **MENU** button for three seconds or longer in any multi-view format. The yellow outline surrounding the video indicates the active cameo, and pressing the arrow buttons moves the active cameo. Pressing the **↵** (Enter) button exits the Active Cameo mode. Selecting **Exit Group Edit** in the cameo menu displayed when pressing the **MENU** button also exits the Active Cameo mode. The active cameo mode will remain in effect for 15 seconds if there is no further operation.

In active cameo mode, press the button for the camera you want to display in the active cameo. After setting the camera number to active cameo, the DVR moves the active cameo to the next cameo. When the camera number exists on the current screen, the active cameo is changed with the existing camera number. When the camera number does not exist on the current screen, the active cameo is replaced by the camera number. You can change the screen layout in this way.

## Zoom Mode

You can enlarge an area of the video by pressing the **ZOOM** button on the front panel. For a few seconds after pressing the **ZOOM** button, a rectangle displays on the screen. A rectangle shows the area that will be enlarged. You can move the rectangle around using the arrow buttons. Pressing the **↵** (Enter) button in the Zoom mode enlarges the area in rectangle. Exit the Zoom mode by pressing the **ZOOM** button. While in the Zoom mode, the icon  displays if Zoom is selected in the Display setup screen (OSD tab).

**NOTE:** The available enlargement ratio is different from camera mode.

## PTZ Mode

If a user who has PTZ Control authority logs into the system, the user can control PTZ cameras. The DVR will control cameras with Pan, Tilt and Zoom capabilities. Press and hold the **PTZ** button on the front panel for three seconds or longer to display the PTZ camera menu and enter the PTZ mode, and press the button again to exit the PTZ mode.

Select the PTZ camera you wish to control by selecting it from the menu. The icon  displays on the PTZ camera screen.



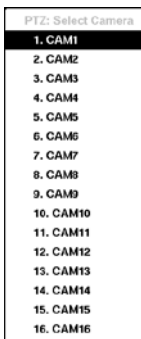

To use the front panel buttons, press the **Left** and **Right** arrow buttons to pan left and right. Press the **Up** and **Down** arrow buttons to tilt the camera up and down. Press the **+** button to zoom in, and press the **-** button to zoom out. You can use the **↔** and **↕** buttons to focus the image.

You can establish preset positions for PTZ cameras. Press the **⏏** button to establish Presets.

You can quickly move PTZ cameras to Preset positions. Press the **⏏** button to view an established camera Preset position.

Figure 44: PTZ Select Camera menu.



Figure 45: PTZ Preset menu.

You can save camera position settings as “presets” so that you can go directly to desired views.

Once you have the camera at the desired settings, press the **⏏** button, and the **Set Preset** dialog box will appear. Select the number you want to assign to the preset and press the **↵** (Enter) button. Use the virtual keyboard to enter the preset name.

Press the **⏏** button to load the PTZ preset and the **Move to Preset** dialog box will appear. Select the desired preset and press the **↵** button to load the preset.



While in the PTZ mode, pressing the **MENU** button and selecting **⏏** (Advanced PTZ) in the menu displaying at the top of the screen displays the Advanced PTZ menu.

Set the feature you wish to control by selecting it from the menu. Refer to the camera manufacturer’s instructions for the proper settings. Depending on the camera specifications, some features may not be supported.

**NOTE: The Pan/Tilt speed can be controlled by using the mouse. While in the PTZ mode, clicking the left mouse button on the image and dragging the mouse in the pan/tilt direction you want to move and then select the speed.**

You can use a mouse for convenient PTZ control. Click the left mouse button on the image and move that image in the direction you want to by dragging the mouse. Use the mouse wheel to zoom in and out. Position the mouse pointer at the bottom of the screen, and the following PTZ toolbar will display.

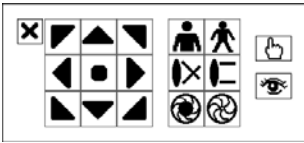

Clicking **X** on the left side exits the toolbar. If you want to display the toolbar again, position the mouse pointer at the bottom of the screen. Change the toolbar location by clicking the empty space on the left side of the toolbar and drag it to where you want it located on the screen. Use the arrow buttons on the toolbar to pan or tilt the camera in the direction you want. The other controls on the toolbar perform as described below:

- Zoom In / Out
- Iris Open / Close
- Advanced PTZ
- Focus Near / Far
- Set / Load Preset

## Event Monitoring

When an event occurs, the DVR will display the camera associated with the event and the icon displays on screen if Event Monitoring On is selected in the Display setup screen (Main Monitor tab).

How the cameras are displayed depends on the number of cameras associated with the event. If one camera is associated with the event, the DVR will display the camera full screen. If two to four cameras are associated with the event, the DVR will display the cameras on a 2x2 screen. If five to nine cameras are associated with the event, the DVR will display the cameras on a 1+5, 1+7 or 3x3 screen. If 10 or more cameras are associated with the event, the DVR will display the cameras on a 4x4 screen.

Event monitoring lasts for the dwell time set for event recording. After the dwell time has elapsed, the monitor returns to the previous screen unless another event has occurred. If you want to return to the live monitoring mode before the dwell time has elapsed, press the **DISPLAY** button or one of the camera buttons.

## Covert Camera

If a camera is set up as Covert 1 in the Camera setup screen (General tab), that camera will not be displayed unless a user with Covert Camera View authority logs into the system. However the camera title and status icons will be displayed on the monitor.

If a camera is set up as Covert 2 in the Camera setup screen (General tab), that camera appears to be Off unless a user with Covert Camera View authority logs into the system. The camera title will be grayed out and status icons will not be displayed on the monitor.

**NOTE: When a camera is set up as Covert 1, the DVR displays the camera title and status icons on the covert video. When set up as Covert 2, the DVR displays only the camera title on the covert video.**

If a user who has Covert Camera View authority logs into the system, the user can view video from cameras set to Covert 1 or Covert 2 including the camera titles and status icons.

## Spot Monitoring

**NOTE: Spot monitoring video from network devices will not be supported.**

The multiview screen display (2x2, 1+5, 1+7, 3x3, or 4x4) and sequence monitoring is supported on a Spot Monitor. Selecting **Spot** after pressing the **MONITOR** button or selecting (Monitor) in the Live Monitoring menu allows you to control a Spot Monitor.

Select (Display) → **Screen Format** in the Live Monitoring menu and then select the screen mode between 2x2 and 4x4 you want to display on a Spot Monitor.

Selecting (Sequence) in the Live Monitoring menu causes the cameras to display sequentially, and selecting again stops sequencing on a Spot Monitor. Any cameras that are Off, have lost video or are set to **COVERT** (unless the user has authority to view covert cameras) will be excluded from the sequence. When the Spot Monitor is in the sequence mode, you can set the camera's display dwell time. Refer to *Chapter 3 – Configuration – Display Setup* section for details.

**NOTE: Sequence cannot be used in the 4x4 display mode of the 16-channel.**

## Status Monitoring

Selecting  (Status) in the Live Monitoring menu or Search menu displays the Event Status screen.

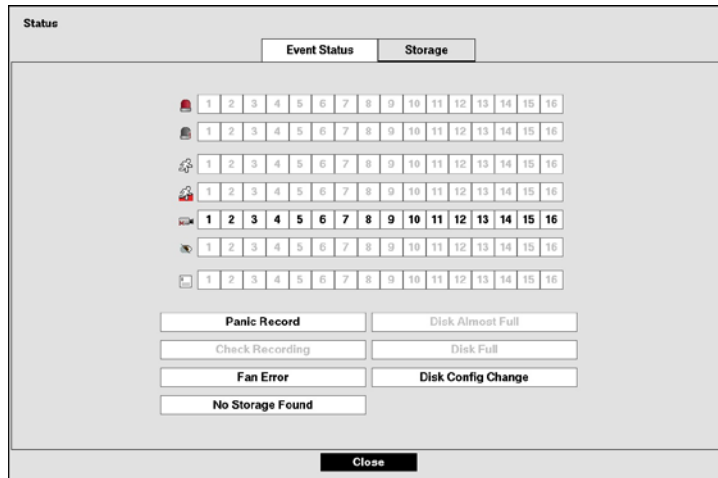

Figure 46: Event Status – Event Status screen.

The Event Status screen displays the status of the DVR's systems and inputs. Events will be highlighted, and related channels or events will flicker for five seconds when detected.

(Alarm-In), (Motion), (Tripzone), (Video Loss), (Video Blind) and (Text-In) will be highlighted when each event is detected based on the settings you made in the Alarm-In, Motion, Video Loss, Video Blind and Text-In setup screen on the Event menu.

(Check Alarm-In) and Check Recording will be highlighted when each event is detected based on the settings you made in the System Event setup screen on the System menu.

Panic Record will be highlighted while the DVR is in the panic recording mode.

Disk Almost Full will be highlighted when the DVR is not in the Recycle mode and the level of disk usage reaches the Disk Almost Full percentage you made in the System Event setup screen on the System menu. Disk Full will be highlighted when the DVR is not in the Recycle mode and all available storage space has been used. Disk Config Change will be highlighted when the DVR reboots after the hard disk drive has been replaced.

Fan Error will be highlighted when the cooling fan to the left of the power cord on the rear panel is not working for more than four seconds.

No Storage Found will be highlighted when there is no storage device for recording is installed in the DVR when the DVR boots for the first time.

Highlighting the Storage tab will display the hard disk drive status.

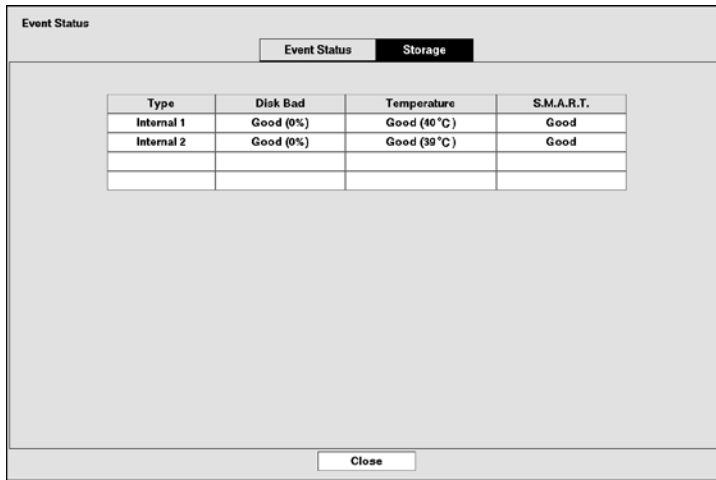

Figure 47: Event Status – Storage screen.

The **Type** column displays the type of storage device.

The **Disk Bad** column displays the percentage of bad sectors. **Not formatted** indicates the device is not formatted.

The **Temperature** column displays the temperature of the storage device.

The **S.M.A.R.T.** column displays “Good”, “Bad” or “N/A”, depending on storage conditions.

- **Good** – The storage condition is normal.
- **Bad** – Data cannot be written on or read from the storage device.
- **N/A** – Storage conditions are normal, however, the S.M.A.R.T. monitoring is not working or supported.

**NOTE:** When the storage condition is “Bad”, the Event Status – Storage screen displays and you can check the storage condition for details. Once the “Bad” message displays, replacing the hard disk drive is recommended, usually within 24 hours.

*Temperature* and *S.M.A.R.T.* information will be available only for internal hard disk drives supporting the SMART (Self-Monitoring Analysis and Reporting Technology) monitoring program.

## Recording Video

Once you have installed the DVR following the instructions in *Chapter 2 — Installation*, it is ready to record. The DVR will start recording based on the settings you made in the Record setup screen. See *Chapter 3 — Configuration*.

**Recycle On or Recycle Off.** The factory default is **Recycle On**. It does this by recording over the oldest video once the hard disk is full. Setting the DVR to **Recycle Off** causes it to stop recording once the hard disk is full.

Although you will be able to record without changing the unit from its original factory settings, you will want to take advantages of the DVR’s many tools. See *Chapter 3 — Configuration* for detailed descriptions of the recording mode options.

## Panic Recording

Selecting **!** (Panic) in the Live Monitoring menu or pressing the **PANIC** button starts panic recording of all cameras, and selecting **!** or pressing the button again stops panic recording. If you set the Panic Recording Duration in the Panic Record setup screen, panic recording will stop automatically according to the preset duration as long as **!** is not selected or the **PANIC** button is not pressed.

**NOTE:** When the DVR is not in the Recycle mode and all available storage space has been used, panic recording will not operate.

## Recording Audio

If the DVR was set up to record audio, it will record audio from up to four inputs when video is recording.

**NOTE:** Make certain you comply with all local and federal laws and regulations when recording audio.

## Playing Recorded Video

If a user who has Search authority logs into the system, the user can view recorded image. Once video has been recorded, you can view it by pressing the **SEARCH** button.

The DVR supports the Triplex function: monitoring, recording and playing back at the same time. Pressing the **SEARCH** button when in one of the multi-view formats enters the Triplex mode and displays the Select Playback Camera menu.

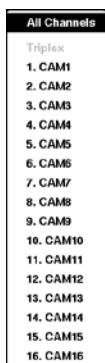

Selecting All Channels plays back video of all cameras. The DVR maintains the same display format as it does in the live mode except for the PIP format. You can also change the screen layout in the same way as you do in the live mode.

Selecting the camera number under Triplex enters the Triplex mode and plays back video of the selected camera. When in the single-screen display format, the camera currently displayed on the screen will be selected and when in the PIP display format, the camera displayed on the PIP screen will be selected for the search channel. During the Triplex mode, the DVR maintains the same display format as it does in the live mode. A red outline surrounding the video and the camera title indicates the search channel. While in the Triplex Mode, the DVR continues recording cameras as they were set up in the recording schedule. Also, live monitoring will continue except for the camera that has been selected for playback.

Figure 48: Select Playback Camera menu.



When playing video for the first time, the DVR will display the most recent image. When playing video subsequent times, the DVR will start playing video from the last recalled image. Recorded audio will be played when the DVR displays a camera with recorded audio in full screen mode.

**NOTE:** Only the administrator and users with *Covert Camera View* authority can view video from covert cameras. The covert cameras in the playback mode are determined by the current camera settings.

**Camera Buttons:** Pressing the individual camera buttons will cause the selected camera to display full screen.

**Arrow Buttons:** Pressing the **⏮** button plays video backward at high speed. Pressing the button again toggles the playback speed from **⏮**, **⏪** and **⏩**. Pressing the **⏭** button plays video forward at high speed. Pressing the button again toggles the playback speed from **⏭**, **⏫** and **⏬**. When in the pause mode, pressing the **⏸** button moves to the next image and pressing the **⏪** button moves to the previous image.

**Play/Pause Button:** Pressing the  button plays back images at regular speed or pauses playing video.

**Search Button:** Pressing the **SEARCH** button enters the search mode, and pressing the button again exits the search mode. When entering the search mode, video is paused. Pressing the  (Enter) button plays back video at regular speed. The screen displays  when the DVR is in the Pause mode and the screen displays  when the DVR is playing back video.

**Zoom Button:** Pressing the **ZOOM** button zooms in the current image on the screen.





**NOTE: The available enlargement ratio is different from camera mode.**

**Display Button:** Pressing the **DISPLAY** button toggles different display formats.

**Group Button:** Pressing the **GROUP** button changes the screen from the current camera group to the next camera group, and the screen displays page number.

You can use a mouse for convenient playback control. Position the mouse pointer on the playback screen, and the following Record Table Search (Compact View Mode) screen will display. The individual controls on the toolbar perform the following functions as described below:



-  Go to the previous image
-  Play/Pause
-  Go to the next image
-  Fast backward play
-  Fast forward play

## Searching Video

While in the search mode, pressing the **MENU** button displays the following Search menu on the right edge of the screen. Pressing the **MENU** button again hides the menu. You can navigate through menus and items by pressing the arrow buttons.







- ① Search
- ② Go To
- ③ Bookmark
- ④ Display
- ⑤ Previous Group
- ⑥ Next Group
- ⑦ Alarm
- ⑧ Panic
- ⑨ Camera Menu
- ⑩ Export
- ⑪ Status
- ⑫ Data Source
- ⑬ Exit

Figure 49: Search menu.



**NOTE: The Search menu also can be displayed by moving the mouse pointer on the right edge of the screen.**

## Search Menu

### Search



- **Event Log Search:** Selecting  (Search) → Event Log Search selects video from the event log. See the following *Event Log Search* section for details.
- **Record Table Search:** Selecting  (Search) → Record Table Search selects using a recording table. See the following *Record Table Search* section for details.
- **Motion Search:** Selecting  (Search) → Motion Search selects motion events. See the following *Motion Search* section for details.
- **Text-In Search:** Selecting  (Search) → Text-In Search selects text input strings. See the following *Text-In Search* section for details.

### Go To

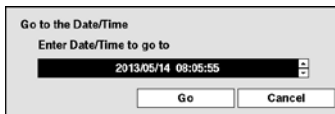
- **Go to the First:** Selecting  (Go To) → Go to the First displays the first recorded image.
- **Go to the Last:** Selecting  (Go To) → Go to the Last displays the last recorded image.
- **Go to the Date/Time:** Selecting  (Go To) → Go to the Date/Time displays the Go to the Date/Time screen.











Move the cursor over the date and time and press the  (Enter) button. You can use the Left and Right arrow buttons to highlight the year, month, day, hours, minutes and seconds. Use the Up and Down arrow buttons to change to the date and time you want to search for video.

Once you have set the date and time you want, press the  button. Then highlight **GO** and press the  button. The selected date and time will display. (If no video was recorded during the selected time, a message appears alerting you that no image was recorded at that time.) The  button and arrow buttons can now be used to review the surrounding video.



### Bookmark

Selecting  (Bookmark) in the Search menu adds the current playback point to the bookmark list. See the following *Bookmarks* section for details.

### Display

- **Full Screen:** Selecting  (Display) →  (Full Screen) and choosing the camera number button displays the selected camera full screen. It is the same as pressing the individual camera buttons on the front panel or clicking the left mouse button on a camera image when in one of the multiview formats (i.e., 2x2, 1+5, 1+7, 3x3 or 4x4). Clicking the left mouse button on the screen again returns to the previous display mode.
- **2x2, 1+5, 1+7, 3x3, 4x4:** Selecting  (Display) → , , ,  or  (2x2, 1+5, 1+7, 3x3 or 4x4) displays the cameras in the selected multiview screen mode (2x2, 1+5, 1+7, 3x3 or 4x4). Selecting each display mode is the same as pressing the **DISPLAY** button or scrolling the mouse wheel up and down when in one of the multiview formats (i.e., 2x2, 1+5, 1+7, 3x3 or 4x4).
- **Camera OSD, Status OSD:** Selecting  (Display) → Camera OSD or Status OSD toggles Camera OSD or Status OSD On and Off.



### Previous Group, Next Group

Selecting  or  (Previous Group or Next Group) in the Search menu moves to the previous or next page. It is the same as pressing the **GROUP** button.





### Alarm

Selecting  (Alarm) in the Search menu resets the DVR's outputs including the internal buzzer during an alarm.

## Panic





Selecting  (Panic) in the Search menu starts panic recording of all cameras, and selecting  again stops panic recording. It is the same as pressing the **PANIC** button.

## Camera Menu

- **Zoom:** Selecting  (Camera Menu) → **Zoom** and choosing the camera number zooms the current playback image of the selected camera on the screen. It is the same as pressing the **ZOOM** button. Selecting **ZOOM** again exits the Zoom mode.
- **Audio:** Selecting  (Camera Menu) → **Audio** toggles audio playback On and Off. Recorded audio will be played when the DVR displays a camera with recorded audio in full screen mode.
- **Edit Group:** Selecting  (Camera Menu) → **Edit Group** enters to the Active Cameo mode. It is the same as pressing and holding the  button in any multiview formats. Refer to the previous *Live Monitoring – Active Cameo Mode* section for details.

**NOTE:** The *Camera Menu* also can be displayed by clicking the right mouse button on the screen while in the search mode.

## Export

- **A–B Clip-Copy:** Selecting  (Export) → **A–B Clip-Copy** will set the starting point of the video to be clip copied, and the  icon displays at the bottom-left corner of the screen. Selecting **A–B Clip-Copy** again will set the ending point of the video to be clip copied and displays the **Clip-Copy** screen. See the following *Clip Copy* section for details.
- **Clip-Copy:** Select  (Export) → **Clip-Copy**, and the **Clip-Copy** screen appears to allow clip copy setup. See the following *Clip Copy* section for details.
- **Print:** Selecting  (Export) → **Print** allows you to print a selected image. See the following *Print* section for details.

## Status

Selecting  (Status) in the Search menu allows you to check the status of the DVR's system, inputs and storage. Refer to the previous *Live Monitoring – Status Monitoring* section for details.

**NOTE:** Selecting **Status** will only be enabled for a user who has **System Check** authority.

## Data Source

Selecting  (Data Source) in the Search menu allows you to select the data source to be searched. Selecting **Record** searches recorded data on primary storage installed in the DVR, and selecting **Other** searches recorded data on storage used for another DVR then installed in this DVR.

## Exit

Selecting  (Exit) in the Search menu exits the search mode and enters the live monitoring mode.



## Event Log Search

Time	Type	Title
2014/10/14 06:49:19	Panic Off	
2014/10/14 05:54:39	Motion 1	CAM1
2014/10/14 05:54:36	Motion 3	CAM3
2014/10/14 05:54:29	Motion 1	CAM1
2014/10/14 05:54:24	Motion 1	CAM1
2014/10/14 05:54:18	Motion 1	CAM1
2014/10/14 05:54:18	Motion 3	CAM3
2014/10/14 05:54:15	Motion 3	CAM3
2014/10/14 05:54:09	Motion 3	CAM3
2014/10/14 05:54:01	Motion 1	CAM1
2014/10/14 05:53:53	Motion 3	CAM3
2014/10/14 05:53:51	Motion 1	CAM1
2014/10/14 05:53:30	Motion 1	CAM1
2014/10/14 05:53:30	Motion 3	CAM3
2014/10/14 05:53:08	Motion 3	CAM3

Figure 50: Event Log Search screen.

The DVR maintains a log of each time the Alarm Input port is activated. The Event Log Search screen displays this list. Use the arrow buttons to highlight the event for which you would like to see video.

There is no determined user authority to display the Event Log Search screen, however, the event video will not be played unless a user with Search authority logs into the system.

Pressing the  (Enter) button will extract the event video and display the first image of the event. Pressing the  button will start playing the “event” video segment. Pressing  returns to live monitoring.

**NOTE:** It is possible that no recorded image displays on the current screen. Press the  button and change the screen mode to 4x4. You will be able to easily see the camera have recorded video during target time.

You can also narrow your event search by selecting the Option... button and setting up the new search condition.

You can search video from the first to last recorded images, or you can set the start and stop times and dates.

Highlight the box beside From and press the  button to toggle between On and Off. When set to Off, you can enter a specific Date and Time. When set to On, the search will be from the first recorded image. When highlighting  and pressing the  button the bookmark list displays and the bookmark point you selected will be the starting date and time.

Highlight the box beside To and press the  button to toggle between On and Off. When set to Off, you can enter a specific Date and Time. When set to On, the search will be from the last recorded image. When highlighting  and pressing the  button the bookmark list displays and the bookmark point you selected will be the ending date and time.

Highlight the box beside **Check Time Overlap** and press the  button. It toggles between On and Off. You will only be able to turn the Check Time Overlap on or off if a user-defined date and time is set to From and To. If the DVR's date and time have been reset, it is possible for the DVR to have more than one overlapping start and stop time. When set to On, you will be asked to select one of the overlapping start and stop time. When set to Off, the DVR will display search results from all start times to all stop times.

Highlight the box beside **Alarm-In** and press the  button. You can select the alarm inputs that you want to include in your search.

Highlight the box beside **Motion** and press the  button. You can select the cameras for which you want any reports of motion.

Highlight the box beside **Video Loss** and press the  button. You can select the cameras for which you want any reports of lost video.

Highlight the box beside **Video Blind** and press the  button. You can select the cameras for which you want any reports of blind video.

Highlight the box beside **Text-In** and press the  button. You can select the text-in devices which you want any reports of text input.

Highlight the box beside **Record Channels** and press the  button. You can select the cameras that you want to search for any reports of event recorded data. The DVR will display the events (not the camera channels) that occurred and that also are recorded on the camera channel that you selected. If you do not select a camera channel in this field, the DVR will search events that are not associated with cameras.

You can also toggle On and Off self-diagnostic System Events as part of your search. The choices are:

- Panic Record
- Check Recording
- Check Alarm-In
- Disk Almost Full
- Disk Bad
- Disk Temperature
- Disk S.M.A.R.T.
- Fan Error
- Disk Config Change

Once you set your desired search conditions, highlight **Search** and press the  button to display the search results in the **Event Log Search** screen. Selecting **Cancel** exits the screen without saving the changes.

## Record Table Search

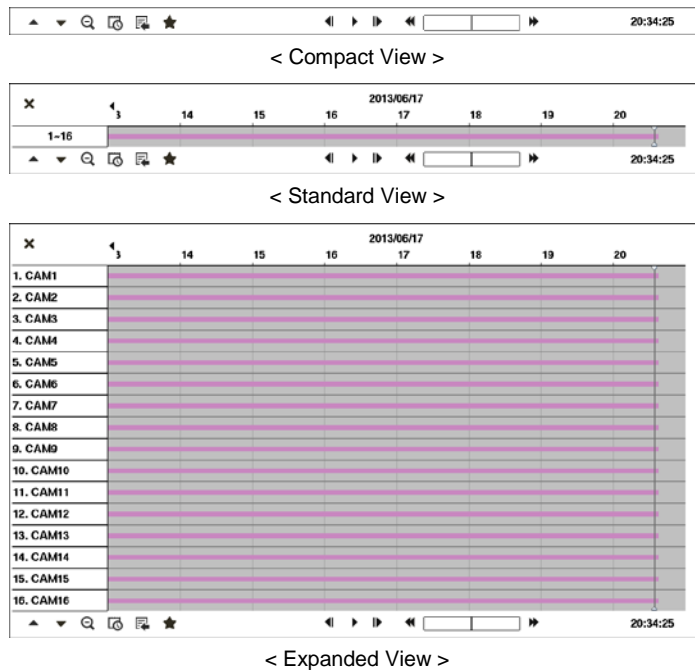

Figure 51: Record Table Search screen.

Recording information about video images currently displayed on the screen displays on the recording status bar. A grey vertical line indicates the current search position. To search specific video, move the vertical line by using the Left or Right arrow buttons on the front panel or by clicking the mouse on the desired segment.

If the DVR's time and date have been reset to a time that is earlier than some recorded video, it is possible for the DVR to have more than one video stream in the same time range. In this case, the overlapping time range in the record table will be separated by a yellow vertical line.

**NOTE: The recorded data in the time range located after the yellow vertical line is the latest.**

There are three view modes. Standard view, Expanded view and Compact view. Standard view (default) displays combined recording information of all camera channels currently displayed on the screen. In the Standard view mode, selecting the ▲ icon located at the bottom switches to the Expanded view mode. The Expanded view displays the recording information of each camera channel currently displayed on the screen. Selecting the ▼ icon in the Standard view mode switches to the Compact view mode which displays only the toolbar. Selecting the ▲ icon in the Compact view mode switches to the Standard view mode, and selecting the ▼ icon in the Expanded view mode switches to the Standard view mode.

Selecting 🔍 or 🔍 located at the bottom zooms the record table. Selecting 🔍 displays eight hours (12 hours with 1920x1080 resolution) (1-minute based), and selecting 🔍 displays 24 hours (3-minute based) at once. To move to earlier or later times that are not shown in the current record table screen, select the arrows located at the end of the times by using the arrow buttons on the front panel.

**NOTE: If the DVR has images recorded in more than one recording mode in the same time range, the recording status bar displays recording information in the following priority order: Panic → Pre-Event → Event → Time. The color of the bar indicates different recording modes: Red for Panic, Yellow for Pre-Event, Purple for Event, and Blue for Time.**

Selecting  located at the bottom displays the Calendar Search screen.





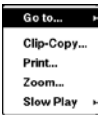

Days with recorded video display on the calendar with white numbers. You can highlight the days with recorded video by using the arrow buttons. Once you have highlighted a day, press the  (Enter) button to select it. The first recorded image of the selected date will pause on the screen. Once you have selected the date you want to search, review the surrounding video by using the playback controls located at the bottom of the Record Table Search screen.

Selecting  located at the bottom displays the Search menu.



- Go To: Displays the first or last recorded image, or searches by date and time (see the previous *Searching Video – Go To* section of this chapter for more details).
- Clip-Copy: Clips a video segment and saves it (see the following *Clip Copy* section for more details).
- Print: Prints the current playback image.
- Zoom: Zooms the current playback image.
- Slow Play: Plays video at low speed (x1/2, x1/3, x1/4, x1/6 and x1/8).

The individual playback controls at the bottom perform the following functions as described below:

-  Go to the previous image
-  Play/Pause
-  Go to the next image
-  Fast backward play
-  Fast forward play

Selecting  located at the bottom displays the Bookmarks screen. See the following Bookmarks section for details.

Selecting  in the top-left corner exits the Record Table Search screen.

## Motion Search

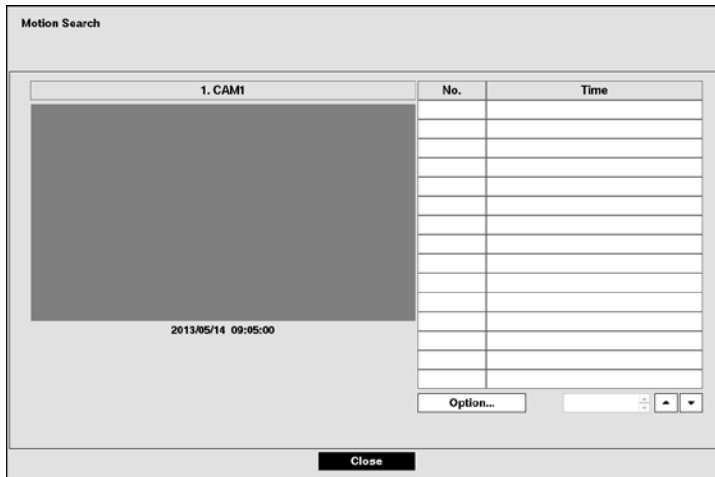





Figure 52: Motion Search screen.

The Motion Search... can be selected from the Search menu while the DVR displays the camera full screen. The Motion Search screen displays a list of motion events. Use the arrow buttons to highlight the event for which you would like to see video and press the  (Enter) button to display the video associated with the selected event on the small search screen.

Highlighting Close and pressing the  button will extract the video associated with the Motion event and display the first image of the event. Pressing the  button will start playing the “event” video segment. Pressing **SEARCH** returns to live monitoring.

You can also narrow your event search by selecting the Option... button and setting up the new search condition.

You can search video from the first to last recorded images, or you can set the start and stop times and dates.

Highlight the box beside **From** and press the  button to toggle between On and Off. When set to Off, you can enter a specific Date and Time. When set to On, the search will be from the first recorded image. When highlighting  and pressing the  button the bookmark list displays and the bookmark point you selected will be the starting date and time.

Highlight the box beside **To** and press the  button to toggle between On and Off. When set to Off, you can enter a specific Date and Time. When set to On, the search will be from the last recorded image. When highlighting  and pressing the  button the bookmark list displays and the bookmark point you selected will be the ending date and time.

Highlight the box beside **Type** and press the  button. You can select between **Motion Search** and **Museum Search**. **Motion Search** detects motion in the defined area. **Museum Search** detects if a defined object has moved.

Highlight the box beside **Zone** and press the  button. An image from the video appears with a grid overlaid. You can turn sensor blocks On and Off to define the area of the picture in which you want to search for motion.

**NOTE: Defining the area of the image in which you want to search for motion is nearly identical to setting up the DVR for Motion. Please refer to *Motion Screen* in *Chapter 3 — Configuration* for more detailed instructions on setting up the detection blocks.**

**When setting the Museum Search Zone, the zone should be placed inside of the border line of the target object. If the selected block is placed on the border line, the sensitivity of the Museum Search may decrease.**

The zone should be placed or focused on the centre or, at least, within the outline of targeted object.

Highlight the box beside **Sensitivity** and press the  button. You will be able to select from 1 (low sensitivity) to 5 (high sensitivity).

Highlight the box beside **Min. Blocks** and press the  button. You will be able to set the number of sensor blocks that must be activated.

Once you set your desired search conditions, highlight **Search** and press the  button to display the search results in the **Motion Search** screen. Selecting **Cancel** exits the screen without saving the changes.

When you search for motion events of another camera, you will be asked whether or not you want to delete the previous search results from the list.

## Text-In Search

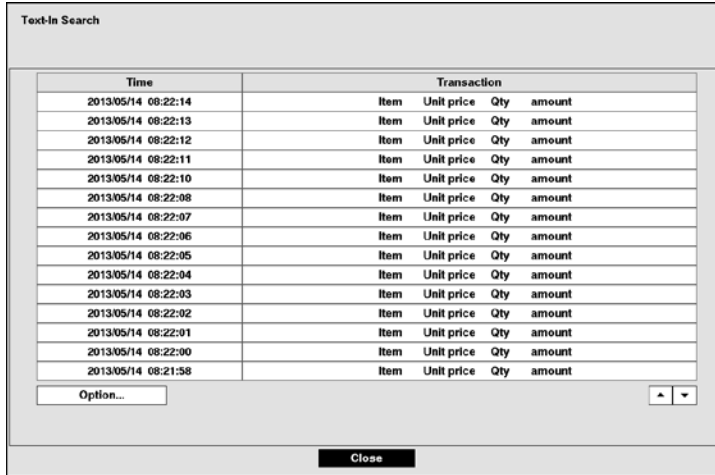

Figure 53: Text-In Search screen.

The DVR maintains a log of each time there is Text Input. The Text-In Search screen displays this list. Use the arrow buttons to highlight the event for which you would like to see video.



Pressing the  (Enter) button will extract the video associated with the Text Input and display the first image of the event. Pressing the  button will start playing the “event” video segment. Pressing  returns to live monitoring.

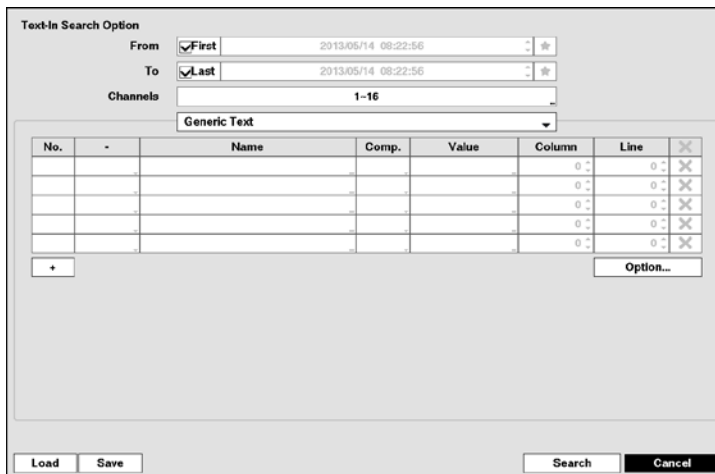

**NOTE:** It is possible that no recorded image displays on the current screen. Press the  button and change the screen mode to 4x4. You will be able to easily see the camera have recorded video during target time. Text Input information will be overlaid on the image while the recorded video is played at regular speed.

You can also narrow your event search by selecting the Option... button and setting up the new search condition.



You can search video from the first to last recorded images, or you can set the start and stop times and dates.

Highlight the box beside **From** and press the  button to toggle between On and Off. When set to Off, you can enter a specific Date and Time. When set to On, the search will be from the first recorded image. When highlighting  and pressing the  button the bookmark list displays and the bookmark point you selected will be the starting date and time.

Highlight the box beside **To** and press the  button to toggle between On and Off. When set to Off, you can enter a specific Date and Time. When set to On, the search will be from the last recorded image. When highlighting  and pressing the  button the bookmark list displays and the bookmark point you selected will be the ending date and time.

Highlight the **Channel** and press the  button. Select the text-in devices that you want to search for text input.

Highlight the **Text Input Device** box and press the  button. Select your Text Input Device from the list.

Highlighting the + and pressing the  button allows you to add a new set of search parameter. Set up the desired search parameter. Refer to the *Appendix – Text-In Search Examples* for further information on setting up search parameters. The **X** column can be used to delete a set of search parameter or entire sets of search parameters.

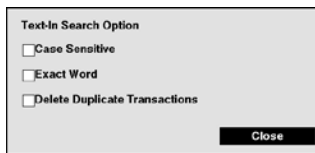

Highlighting the **Option...** box and pressing the  button allows you to select whether or not the search will find only text strings in which the case matches, find only exact words that match with the word you entered during text-in setup, or delete transactions duplicated within text input strings.

Highlight **Load** and press the  button to load saved search option settings. Select the desired search option settings.

Highlight **Save** and press the  button to save the current search option settings. A virtual keyboard appears that you can use to enter the search option name.

Once you set your desired search conditions, highlight **Search** and press the  button to display the search results in the **Text-In Search** screen. Selecting **Cancel** exits the screen without saving the changes.

## Bookmarks

The **Bookmarks** screen can also be accessed by selecting **Bookmark** in the **Search** menu.

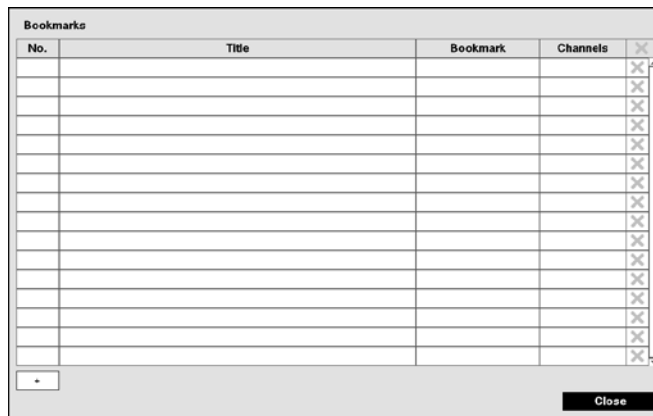



Figure 54: Bookmarks screen.

Highlight + and press the  (Enter) button to add the current playback point to the bookmark list. Highlight the **Title** box and enter the name of the registered bookmark. Use the virtual keyboard to enter the bookmark name. The **X** column can be used to delete a Bookmark.

**NOTE: Up to 64 bookmarks can be registered.**

Use the arrow buttons to highlight the bookmark point for which you would like to see video. The selected bookmark will display on the screen by pressing the  button.

## Clip-Copy

Video clips can be copied on an external USB hard disk or flash drive. The copied video clips can be viewed on computers running Microsoft Windows 2000, XP, Vista or 7. Refer to the *Appendix – USB Hard Disk Drive Preparation* for information on preparing the external drive for clip copy.

Selecting A–B Clip-Copy in the Search – Export menu or pressing the **BACK UP** button on the remote control during playback will set the starting point of the video to be clip copied, and the  icon displays at the bottom-left corner of the screen. Selecting A–B Clip-Copy in the Search – Export menu or pressing the **BACK UP** button again will set the ending point of the video to be clip copied by displaying the Clip-Copy screen.

Pressing and holding the **BACK UP** button on the remote control for more than three seconds while in the Search mode or Live Monitoring mode initiates the One-Touch Clip Copy function. The last recorded image will be the ending point of video to be clip copied, and the system will automatically begin to calculate the possible video data size that the selected storage media can handle.

Select Clip-Copy in the Search – Export menu or press the **BACK UP** button on the remote control while in the Live Monitoring mode, and the Clip-Copy screen appears to allow clip copy setup.

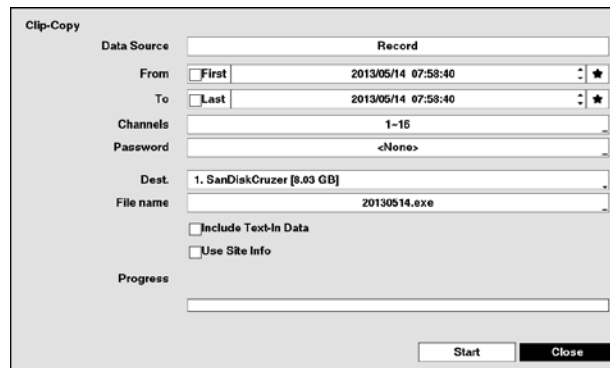









Figure 55: Clip-Copy screen.

You can search video from the first to last recorded images, or you can set the start and stop times and dates.

Highlight the box beside **From** and press the  (Enter) button to toggle between On and Off. When set to Off, you can enter a specific Date and Time. When set to On, the search will be from the first recorded image. When highlighting  and pressing the  button the bookmark list displays and the bookmark point you selected will be the starting date and time.

Highlight the box beside **To** and press the  button to toggle between On and Off. When set to Off, you can enter a specific Date and Time. When set to On, the search will be from the last recorded image. When highlighting  and pressing the  button the bookmark list displays and the bookmark point you selected will be the ending date and time.

Highlight the box beside **Channels** and press the  button. You can select the cameras that you would like to include in your video clip.

Highlight the box beside **Password** and press the  button. A virtual keyboard appears allowing you to enter the password for reviewing the video clips.

Highlight the box beside **Dest.** and press the  button. You can select the storage device or a NetFS site on which you would like to record the video clip. If you enabled the NetFS function (**Network** menu > **NetFS** tab) and set the **Use** setting to **ALL** or **Clip-Copy**, you can copy video clips to the NetFS site. If you select **NetFS**, select a NetFS site from the registered NetFS site list.

**CAUTION: The USB device for clip copy must be FAT 16 or FAT32 format.**



**NOTE:** When copying video clips on a NetFS site, you cannot check the disk volume of the NetFS site for the video clips to be uploaded. The DVR displays the volume as 30GB regardless of the actual disk volume, and limits the file size for clip copy to 30GB. If upload fails after video clips are copied, the copied video clips will be deleted. If the same file exists, video clips will not be copied.

The DVR automatically assigns a file name to the video clip. However, you can give the video clip file a different name. Highlight the box beside File Name and press the  button. A virtual keyboard appears. Enter a file name for the video you are backing up and select Close. The DVR will automatically add the camera number (for example "01") and ".exe" to the file name.

**NOTE:** When naming a file, you cannot use the following characters: \, /, :, \*, ?, ", <, >, |.

Highlight Include Text-In Data and press the  button. This will toggle between On and Off. When this feature is On, you can include text-in data when copying video if the video was recorded with text-in data.

Highlight Use Site Info and press the  button. This will toggle between On and Off. When this feature is On, you can add the site information to the file name for the video you are backing up.

**NOTE:** When the site information is added to the file name, some special characters (\, /, :, \*, ?, ", <, >, |) in the site information will be converted to "\_".

Once you have given the video clip a file name, highlight the Start button and press the  button. The confirmation screen displaying data size will appear. When the storage device does not have enough space, the DVR will ask if you want to copy as much of the video clip as possible in the available space. Highlight the Continue button and press the  button to continue clip copy.

Once the clip copy starts, you can cancel it by selecting Cancel or hide the screen by selecting Close. When selecting Close, Clip Copy continues and a confirmation screen will display when complete.

**NOTE:** When copying video clips larger than 2GB, the video clips will be save in units of 2GB. For example, 3 individual 2GB files will be created when saving a 6GB video clip.

You can use other functions on the DVR while video is being backed up. To do this, highlight the Close button and press the  button. You can return to the Clip-Copy screen at any time to check the progress.

You do not need to install any special software on your personal computer to review the video clips. Refer to RAS manual for instructions on how to review video clips you have copied.

**NOTE:** During Clip Copy, you cannot shut the system down, clear data on the storage device, or format the storage device.

**CAUTION:** Do NOT disconnect the USB cable or the power from the external drive while copying video clips. If the external drive is shut down or the USB cable is disconnected while copying video clips, THE DVR SYSTEM MAY NOT WORK NORMALLY OR THE EXTERNAL DRIVE COULD BE DAMAGED, and you will get an error message the next time you try to copy video clips. You will need to power down the DVR and restart it to get rid of the error message. Once the file system of the USB hard disk drive has been corrupted, this error message cannot be dismissed. Even after restarting the DVR it may automatically restart while preparing to clip copy. You must recover the file system using the recovery program, or you must reformat the hard disk drive.

## Print

You can print images on a printer. Connect a PostScript™ printer, or external hard disk drive or flash drive to one of the USB ports. If you enabled the NetFS function (Network menu > NetFS tab), you can upload the images on the registered NetFS site.

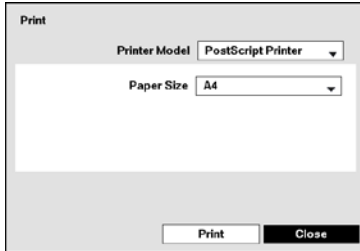

Highlight the box beside Printer Model and press the  button. Selecting PostScript Printer will print images on a PostScript™ printer connected to the DVR. Selecting File Printer will save the current image as a PDF file on an external USB hard disk drive or flash drive or a NetFS site.

**NOTE: Images saved as PDF files can be printed on any printer connected to your PC.**

Highlight the box beside Paper Size and press the  button. You can select the paper size.

Figure 56: Print screen.

Once you have selected the printer model and paper size, highlight the Print button and press the  button. Select USB Storage or NetFS. If you select NetFS, select a NetFS site from the registered NetFS site list. A message appears asking you if you want to print the current image. Highlight the Continue button and press the  button to print.

**NOTE: If your printer only supports an LPT connection (parallel), use an LPT to USB converter cable. The printer cable is not provided.**

## Disk Mirroring

**NOTE: This function is supported only for RAID supported models only. Ask your dealer or distributor for RAID supported models.**

The DVR supports disk mirroring to prevent unexpected loss of recorded video data that might be caused by disk damage or corruption. You can set up disk mirroring by highlighting Storage in the System menu and pressing the  button.

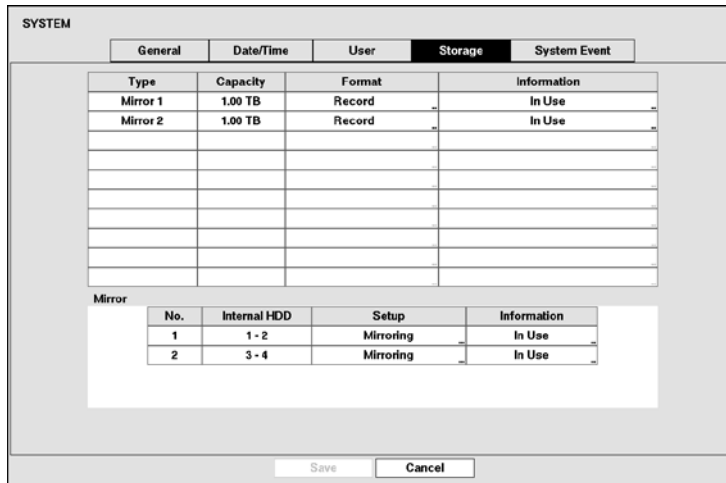

Figure 57: System – Storage setup screen.

The DVR supports mirroring function that records the same data on the two disks at the same time. Up to two Mirrors are supported.

**NOTE:** The capacity and model of the two disks should be the same for proper mirroring between the two disks.

**CAUTION:** If you change the setup related to Mirror, you must reboot the system.

**If disk mirroring fails, you must restart the system before trying disk mirroring again. When a disk mirroring failure is caused by a disk error, you must replace the disk with a new one.**

**This function does not work properly if the connected hard disk has been already used for mirroring in other DVR.**

The number under the No. heading indicates the mirroring number.

Highlighting Internal HDD indicates the available disks for mirroring.

Highlighting Setup and pressing the  button allows you to configure detailed settings related to Mirror.



- **Mirror:** Click OK to start mirroring. Once you start mirroring (writing data on the two disks at the same time between two disks), all existing data on the two disks will be erased.

**NOTE:** Once you start mirroring, all existing data on the two disks will be erased.



- **Stop:** Once mirroring starts, you can stop it by selecting Stop option.

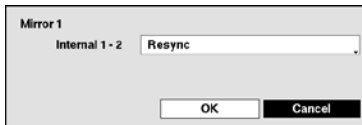

- **Resync:** When a disk is replaced, data on the replaced disk will be erased and data on the other disk will be copied to the replaced disk. Highlighting Resync and clicking OK resynchronizes two disks. After resynchronization is complete, disk mirroring (writing data on the two disks at the same time) will start.

**CAUTION:** Do NOT remove the disk during resynchronization, otherwise the disk may be damaged.

Highlighting Information indicates if the installed disk is being used for mirroring or Resync purposes. Select information about mirroring to check the disk's model and serial number.



## Appendix

### USB Hard Disk Drive Preparation

**NOTE:** The following description is for preparing a USB hard disk drive under Windows 2000. Preparing a USB hard disk drive under Windows XP, Window Vista and Window 7 is almost identical to Windows 2000.

1. Connect the USB hard disk drive to your computer using the USB Cable.
2. Turn on your computer.
3. The USB device icon should display on the Taskbar.
4. If the USB hard disk drive is partitioned or has data, it will show up in *My Computer* as a hard disk drive icon. Check the file system by right clicking on the icon and checking under *Properties > General > File System*. If the file system is NOT FAT32 format, format the USB hard disk drive using the FAT32 format.
5. If the USB hard disk drive is not partitioned, go to *Administrative Tools* in *Control Panel* and launch *Computer Management*. Open *Disk Management* in *Storage* and right click an unallocated region of the USB hard disk drive. Then, click *Create Partition*.
6. In the *Create Partition wizard*, click *Next* then *Primary Partition*, and follow the instructions on the screen. Make sure that the FAT32 is selected for the file system.

**NOTE:** The partition size should be less than 32GB because of Microsoft limitations.

After formatting is complete, the USB hard disk drive will be added to *My Computer*.

7. Connect the USB hard disk drive to the DVR.

### Text-In Search Examples

#### Search Example I

1 2 3 4 5 6  
123456789012345678901234567890123456789012345678901234567890

Item	Unit price	Qty	amount
Coke	\$ 2.20	1(s)	\$ 2.20
Fanta	\$ 2.20	1(s)	\$ 2.20
Hotdog	\$ 3.50	3(s)	\$ 10.50
Pepsi	\$ 1.95	1(s)	\$ 1.95
total :			\$ 16.85

Thank you~~

In the above text-in data, you can find that the comparison value is located at 17<sup>th</sup> (Unit price, \$ mark will be ignored automatically), 28<sup>th</sup> (Qty) and 40<sup>th</sup> (amount) characters (including spaces) from the left. In this case, you can enter "17", "28" and "40" in each Column box.

For example, if you want to search for Coke with a Qty (Quantity) of more than 1 and Hotdog with an amount totaling over \$8, the following search condition can be set.

Text-In Search Option

From  First 2013/06/19 23:37:43

To  Last 2013/06/19 23:37:43

Channels 1-16

Generic Text

No.	-	Name	Comp.	Value	Column	Line	X
1		Coke	>	1	28	0	X
2	AND	Hotdog	>	8	40	0	X
					0	0	X
					0	0	X
					0	0	X
					0	0	X

+ Option...

Load Save Search Cancel

**Search Example II**

1 2 3 4 5 6  
 123456789012345678901234567890123456789012345678901234567890

Item	Unit price	Qty	amount
Coke	\$ 2.20	1(s)	\$ 2.20
Fanta	\$ 2.20	1(s)	\$ 2.20
Hotdog	\$ 3.50	3(s)	\$ 10.50
Pepsi	\$ 1.95	1(s)	\$ 1.95
total :			\$ 16.85

Thank you~~

In the above text-in data, you can find that the comparison value is located at 17th (Unit price, \$ mark will be ignored automatically), 28<sup>th</sup> (Qty) and 40<sup>th</sup> (amount) characters (including spaces) from the left, but the value of amount category is located on a different line from Item. In this case, you can enter "17", "28" and "40" in each Column box and enter "1" in the Line box for the next line.

For example, if you want to search for Coke with a Qty (Quantity) of more than 1 and Hotdog with an amount totaling over \$8, the following search condition can be set.

Text-In Search Option

From  First 2013/06/19 23:37:43

To  Last 2013/06/19 23:37:43

Channels 1-16

Generic Text

No.	-	Name	Comp.	Value	Column	Line	X
1		Coke	>	1	28	0	X
2	AND	Hotdog	>	8	40	1	X
					0	0	X
					0	0	X
					0	0	X

+ Option...

Load Save Search Cancel

## WebGuard

WebGuard allows you to access a remote DVR, monitor live video images and search recorded video using Internet Explorer web browser anytime from virtually anywhere.

Computer system requirements for using the WebGuard program are:

- Operating System: Microsoft® Windows® XP (Service Pack 3), Microsoft® Windows® Vista (Service Pack 1), Microsoft® Windows® 7 (Home Premium, Professional, Ultimate) or Microsoft® Windows® 8 (Pro, Enterprise)
- CPU: Intel Pentium III (Celeron) 600MHz or faster
- RAM: 128MB or higher
- VGA: 8MB or higher (1024x768, 24bpp or higher)
- Internet Explorer: Version 6.0 or later (32-Bit)

Start Internet Explorer on your local PC. You can run the WebGuard program by entering the following information in the address field.

- “http://IP address:port number” (The DVR IP address and the WebGuard port number (default: 12088) set in the Network setup screen (WebGuard tab))
- Or, “http://FEN server address/FEN name” (The FEN server address and the FEN name registered on the FEN server)
- Or, “http://www.dvronline.net” (Entering the DVR IP address or the FEN name will be required when logging in)

**NOTE:** You will need to get the appropriate IP address for the DVR you want to connect to and the WebGuard port number from your network administrator.

**WebGuard only works with Microsoft Internet Explorer and will NOT work with other browsers.**

**WebGuard does not work in Microsoft® Windows® 8 metro UI.**

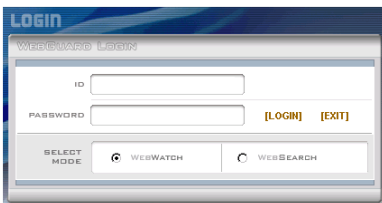

Select between the WEBWATCH (Web monitoring) and WEBSEARCH (Web search) modes. Entering ID and PASSWORD and clicking the [LOGIN] button logs in using the selected mode.

You will need to enter the DVR IP address in the DVR ADDRESS field when running the WebGuard program by entering http://www.dvronline.net. Selecting the Use DVRNS option allows you to enter the FEN name registered on the FEN server instead of the IP address. You must enter the FEN server address and port number in the SETUP setting when selecting the Use DVRNS option.

**NOTE:** Do NOT close the LOGIN window during the WebGuard operation, otherwise, it will cause a script error when switching between Web monitoring and Web search modes, and you will need to restart the WebGuard program.

When running the updated WebGuard for the first time, Internet Explorer might occasionally load the information of the previous version. In this case, delete the temporary internet files by selecting Tools → Internet Options → General tab, and then run WebGuard again.

There might be a problem that the bottom of WebGuard page is cropped due to the address or status bars. In this situation, it is recommended that websites open windows without address or status bars by changing the internet setting. (Go to the Tools → Internet Options → Security tab → Click the Custom level... button → Select *Enable* for the *Allow websites to open windows without address or status bars* option)

When running WebGuard in the Microsoft Windows Vista or higher operating system, it is recommended to start Internet Explorer with elevated administrator permissions. Click the right mouse button on the Internet Explorer icon and select the *Run as administrator* option from the context menu. Otherwise, some functions of the WebGuard might be limited to use.

**NOTE:** There might be a problem with screen display or screen update due to low image transmission speed when using the Microsoft Windows Vista or higher operating system. In this situation, it is recommended that you disable the Auto Tuning capability of your computer.

Run the *Command Prompt* with elevated administrator permissions (Go to the Start Menu → Accessories → Command Prompt → Click the right mouse button and select the *Run as administrator* option). Then enter “netsh int tcp set global autotuninglevel=disable” and hit the enter key. Restart your computer to apply the changes.

If you want to enable the Auto Tuning capability again, enter “netsh int tcp set global autotuninglevel=normal” after running the Command Prompt with elevated administrator permissions. Restart your computer to apply the changes.

## Web Monitoring Mode

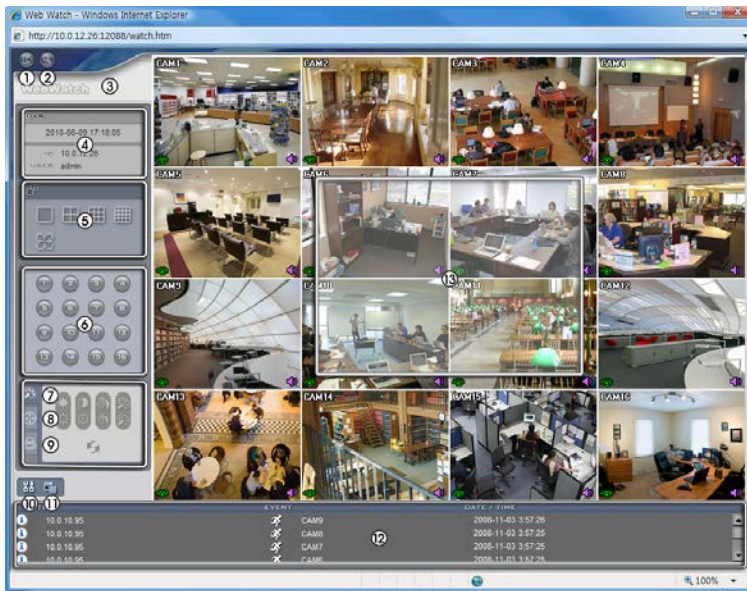

WebWatch is a remote web monitoring program that allows you to monitor live video transmitted in real-time from the remote DVR.



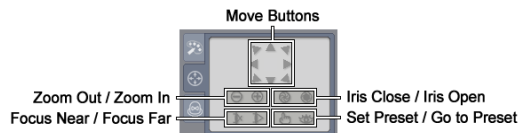
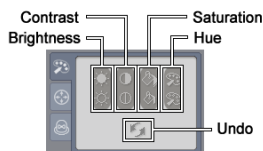



- ① Click the [Logout] to log out the WebGuard program.
- ② Click the [Search] to access to the web search mode.
- ③ Position the mouse pointer on the WebWatch logo to see the version of the WebGuard program.
- ④ The DVR information window displays the login information of WebGuard.
- ⑤ Click the screen format to select the desired display mode. When changing the screen format, the selected camera on the current screen will be located in the first cell of the new layout.
- ⑥ Click the camera button to select the camera to be viewed.
- ⑦ Click the [Adjust] to adjust the brightness, contrast, saturation and hue of monitoring image.
- ⑧ Click the [PTZ] to control pan, tilt and zoom of the camera from a remote site.
- ⑨ Click the [Alarm] to control alarm out devices at the remote site.





- ⑩ Click the  to save the current image as a bitmap or JPEG file format.
- ⑪ Click the  to set up the image drawing mode, OSD display and beep on/off. You can adjust the display speed by changing the image drawing mode, select OSD information to be displayed on the screen, and turn the DVR's internal buzzer on and off from a remote site.
- ⑫ The event status window at the bottom displays a list of events that were detected from the remote site.
- ⑬ Selecting a camera on the screen and clicking the right mouse button displays the text menu screen.

Change Camera Title	
Enable Audio	
Aspect Ratio	▶
MultiStream	▶
Anti-Aliasing Screen	

- **Change Camera Title:** Changes the camera name.
- **Enable Audio:** Enables audio communication with the remote site. When the audio control panel displays, click the  to send audio to the connected remote site and click the button again to stop sending audio. Click the  to monitor live audio from the connected remote site through the attached speaker and click the button again stop monitoring live audio. Clicking both  and  allows two-way communication. Clicking the  disables audio communication.
- **Aspect Ratio:** Changes the image aspect ratio.
- **MultiStream:** Allows you to choose the desired stream if the DVR is in the multistream mode for live monitoring.
- **Anti-Aliasing Screen:** Enhances image display quality by eliminating stair stepping (aliasing) effects in the enlarged image.

**NOTE:** A camera name change in the Web Watch mode does not affect the camera name set up on the remote site. Leaving the Camera Title blank causes the camera name set up on the remote site to display.



The  icon will display on each camera screen when audio communication is available between the WebGuard system and a DVR.

## Web Search Mode

WebSearch is a remote web search program that allows you to search recorded video on the remote DVR.

**NOTE:** The remote site connection in the Web Search mode will automatically be disconnected if there is no activity for 30 minutes.



- ① Click the  to log out the WebGuard program.
- ② Click the  to access to the web monitoring mode.

- ③ Position the mouse pointer on the WebSearch logo to see the version of the WebGuard program.
- ④ The DVR information window displays the time information of recorded data on the remote DVR and login information of WebGuard.
- ⑤ Click the to blur, sharpen, equalize and interpolate playback images. Click the to zoom out or zoom in the recorded image. Click the to adjust the brightness of the recorded images.



**NOTE: Image processing works only in the pause mode.**

- ⑥ The playback function buttons include fast backward, pause, play, fast forward, go to the first image, go to the previous image, go to the next image, and got to the last image.
- ⑦ Click the screen format to select the desired display mode.
- ⑧ Click the to enter the time-lapse search mode which allows you to search for recorded data by time and then play back images found within the time parameters. The Timetable window located at the bottom displays the time information for the image of the date selected on the calendar. If more than one video stream in the same time range, you can select the video stream you want to search. Clicking a specific time displays the image recorded at that time on the screen. Selecting the allows you to display an image from a specific time.
- ⑨ Click the to enter the event search mode which allows you to search for event log entries using specific conditions and play back the images associated with those event entries.
- ⑩ Click the to set up the image drawing mode and OSD display. You can adjust the display speed by changing the image drawing mode, and select OSD information to be displayed on the screen.
- ⑪ Click the to save any video clip of recorded data as an executable file, or click the to save the current image in a bitmap or JPEG file format.

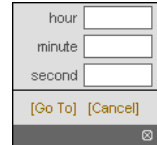

**NOTE: When saving as an executable file, selecting the Exclude Player option will reduce the file size and its saving time. You can download the Player program to review the video clip by entering the following information in the address field of Internet Explorer.**

- When using the FEN: "http://FEN server address/FEN Name/ClipPlayer.exe" (The FEN server address and the FEN name registered on the FEN server)
- When not using the FEN: "http://IP address:port number/ClipPlayer.exe" (The DVR IP address and the WebGuard port number (default: 12088) set in the Network setup screen (WebGuard tab))

- ⑫ Click the to print the current image on a printer connected to your computer.
- ⑬ Click the to reload the recording data.
- ⑭ The Timetable displays recorded data of the selected camera by time (in hour segments).
- ⑮ Selecting a camera on the screen and clicking the right mouse button displays the text menu screen.

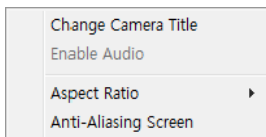

- Change Camera Title: Changes the camera name.
- Enable Audio: Plays audio while playing back recorded video that has recorded audio. (Single-Screen Layout Only)
- Aspect Ratio: Changes the image aspect ratio.
- Anti-Aliasing Screen: Enhances image display quality by eliminating stair stepping (aliasing) effects in the enlarged image.

**NOTE: A camera name change in the Web Search mode does not affect the camera name set up on the remote site. Leaving the Camera Title blank causes the camera name set up on the remote site to display.**

## Time Overlap

If the DVR's time and date have been reset to a time that is earlier than the existing recorded video, it is possible for the DVR to have more than one video stream in the same time range. In this case, you can search overlapping video streams individually by selecting a specific segment. For example, when the DVR has recorded video from one to five o'clock and the user changes the time backward from five to three o'clock and then continues recording until six o'clock, there will be two video streams and segments from three to five o'clock.

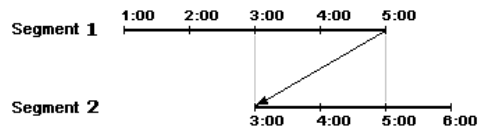

You can search overlapping video streams by selecting a specific time or time range. If you want to search recorded video at four o'clock during the overlapping time range using a search menu such as **Go to the Date/Time**, select the segment you want to search.

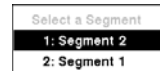

If you want to search recorded video from four to five o'clock during the overlapping time range using a search menu such as **Event Log Search**, **Text-In Search** or **Motion Search**, it is possible for the DVR to have two overlapping start and stop times. You will be asked to select one of the overlapping start and stop times from the search time ranges as follows:

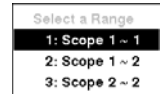

- From four o'clock of the first segment to five o'clock of the first segment
- From four o'clock of the first segment to five o'clock of the second segment
- From four o'clock of the second segment to five o'clock of the second segment

## Error Code Notices

System Upgrade Related		Clip Copy Related	
No.	Description	No.	Description
0	Unknown error.	0	Unknown error.
1	File version error.	1	Device error.
2	Operating system version error.	2	Mounting failed.
3	Software version error.	3	No media.
4	Kernel version error.	4	Invalid media.
100	Upgrade device mounting failed.	5	File already existed.
101	Package is not found.	6	Not enough space.
102	Extracting package failed.	7	Creating temporary file failed.
103	LILLO failed.	8	Opening disk failed.
104	Rebooting failed.	9	Formatting disk failed.
105	Invalid package.	10	Database has been changed.
300	Remote connection failed.	11	Appending failed.
301	Remote network error.	12	Bad sector.
302	Remote upgrade is not authorized.	13	No executable file.
303	Saving remote package failed.	14	Opening executable file failed.
304	Remote upgrade is cancelled by the user.	15	Writing executable file failed.
400	USB device mounting failed.	16	Creating image failed.
401	Reading upgrade package on the USB device failed.	19	Connecting device failed.
402	Copying upgrade package on the USB device failed.	20	Device is busy.

System Upgrade Related		Clip Copy Related	
No.	Description	No.	Description
403	USB device is not connected.	21	Unsupported file system.
404	USB device is being used.	22	Verify failed.
405	Unsupported file system.		
500	System is busy clip copying.		



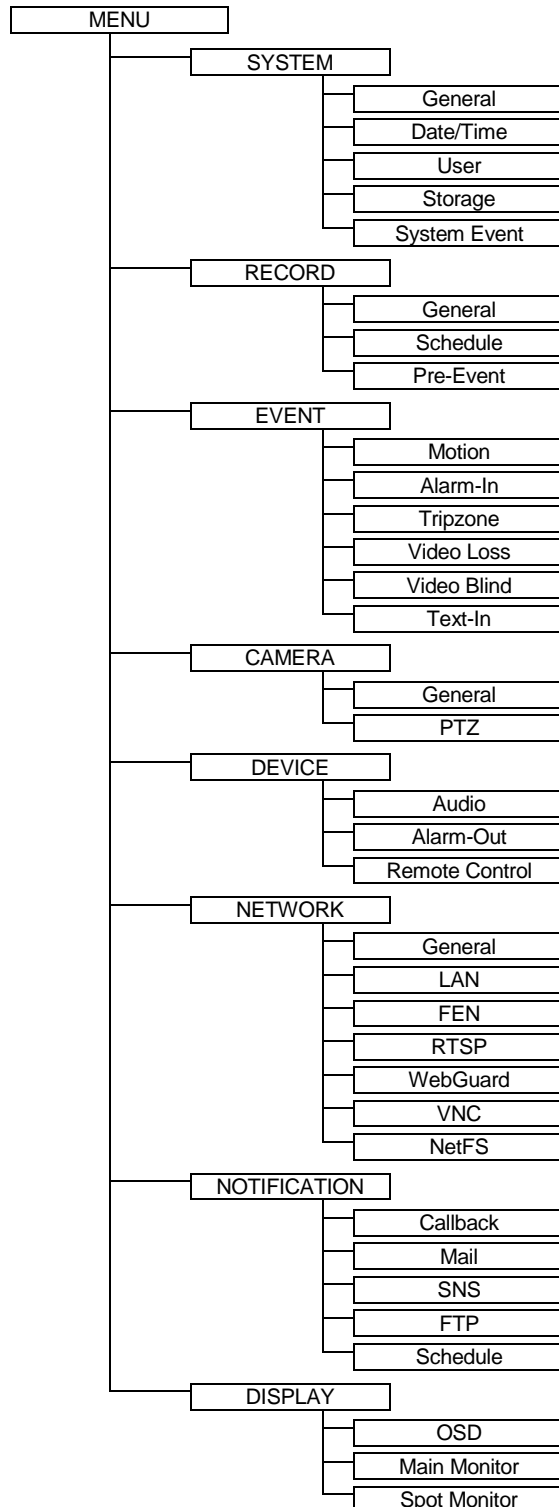

## System Log Notices

Boot Up	Clear All Data
Shutdown	Clear Disk
Restart	Format Disk
Upgrade	Disk Full
Upgrade Fail	Disk Config Change
Power Failure	No storage found
Time Change	Disk 'No.' : 'serial number'
Time Zone Change	Disk 'No.' : Removed
Time Sync	Auto Deletion
Time Sync Fail	Search Begin
Disk Bad	Search End
Login	Clip-Copy Begin
Logout	Clip-Copy End
Setup Begin	Clip-Copy Cancel
Setup End	Clip-Copy Fail
Remote Setup Change	Clip-Copy User:
Remote Setup Fail	Clip-Copy From:
Setup Imported	Clip-Copy To:
Setup Import Failure	Clip-Copy Duration of Video:
Setup Exported	Clip-Copy Camera:
Setup Export Failure	Callback Fail
Setup Export Cancel	Print Begin
Schedule On	Print End
Schedule Off	Print Cancel
Panic On	Factory Reset
Panic Off	Login : VNC (server address)
Connected : NetFS:	Logout : VNC (server address)
Disconnected : NetFS:	

## Map of Screens



## Troubleshooting

Problem	Possible Solution
No Power	<ul style="list-style-type: none"> <li>• Check power cord connections.</li> <li>• Confirm that there is power at the outlet.</li> </ul>
No Live Video	<ul style="list-style-type: none"> <li>• Check camera video cable and connections.</li> <li>• Check monitor video cable and connections.</li> <li>• Confirm that the camera has power.</li> <li>• Check camera lens settings.</li> <li>• Check the current main monitor resolution.</li> </ul>
DVR has stopped recording	If hard disk drive is full, you will either need to delete video or set the DVR to the Overwrite Mode.
The icon  displays, however, the DVR is not recording.	When the DVR is in the Pre-Event recording mode, the yellow  and  display when there is no event, and the DVR is not recording. The red  and  display when any event occurs and the DVR starts recording.
While upgrading the system, the DVR keeps rebooting and the upgrade fails.	If the current system version is higher than the upgrade package file version, you should reset the DVR first using the Factory Reset. When using the Factory Reset, you will lose any settings you have saved.

## Specifications

VIDEO	
Signal Format	NTSC, PAL or HD-TVI (Auto Detect)
Video Input	Composite 8 or 16 inputs: BNC, 1 Vp-p, auto-terminating, 75 Ohms
Monitor Outputs	HDMI: 1 HDMI VGA: 1 SPOT: 1 BNC, 1 Vp-p, 75 Ohms
Video Resolution	HDMI: 3840x2160, 1920x1080, 1440x900, 1280x1024 VGA: 1920x1080, 1440x900, 1280x1024 Composite (SPOT): 720x480 (NTSC), 720x576 (PAL)
Record Speed (images per second)	Real-time: 480ips @ Full HD
Playback Speed (images per second)	Full Duplex: 120ips @ Full HD

INPUTS/OUTPUTS	
Alarm Input	8 or 16 terminal, programmable as NC or NO, 2.4V (NC) or 0.3V (NO) threshold, 5VDC
Alarm Output	4 relay output, programmable as NC or NO, 2A@125VAC, 1A@30VDC (NO)
Alarm Reset Input	1 TTL, terminal block
Internal Buzzer	78dB at 10cm
Network Connectivity	10/100Mbps, 1Gbps Ethernet (RJ-45)
Audio Input	RCA Input: 4 Line In
Audio Output	RCA Output: 1, Line Out
Text Input	POS Interface, ATM Interface

<b>CONNECTORS</b>	
Video Input	Composite 8 or 16 BNC
Monitor Output	HDMI: 1 HDMI VGA: 1 VGA SPOT (Composite): 1 BNC
Audio In	4 RCA connector
Audio Out	1 RCA connector
Alarm Input/Output	Terminal Blocks
Ethernet Port	RJ-45
eSATA Port	eSATA
RS232 Serial Port	Two-connector terminal block
RS485 Serial Port	Two-connector terminal block
IR Port	1 Remote Control
USB Port	2 (USB 2.0)

<b>STORAGE</b>	
Primary Storage	SATA hard disk drive (up to 4)
Secondary Storage	eSATA hard disk drive (RAID) USB hard disk drive or flash drive

<b>GENERAL</b>	
Dimensions (W x H x D)	17" x 3.5" x 16.3" (430mm x 88mm x 415mm)
Unit Weight*	13 lbs. (5.9kg)
Shipping Weight*	19.4 lbs. (8.8kg)
Shipping Dimensions (W x H x D)	21.1" x 9.4" x 21.1" (535mm x 238mm x 535mm)
Operating Temperature	32°F to 104°F (0°C to 40°C)
Operating Humidity	0% to 90%
Power	100 to 240 V~, ≤ 2.0A, 50/60Hz
Power Consumption**	76W
Approvals	FCC, CE, UL, CB, PSE

\* When two hard disk drives of 2TB are installed, the value was measured.

\*\* When four hard disk drives of 3TB are installed, the value was measured.

Specifications are subject to change without notice.



eneo® is a registered trademark of Videor E.  
Hartig GmbH

Exclusive distribution through specialised  
trade channels only.

Videor E. Hartig GmbH  
Carl-Zeiss-Straße 8 · 63322 Rödermark/  
Germany

Tel. +49 (0) 6074 / 888-0 · Fax +49 (0)

6074 / 888-100

[www.videor.com](http://www.videor.com)

[www.eneo-security.com](http://www.eneo-security.com)

Technical changes reserved

© Copyright by Videor E. Hartig GmbH 05/2017